



High Performance Lifting™

COFFING® HOISTS

High Performance Lifting™

COFFING®

HOISTS

The employees of Coffing Hoists pride themselves in offering a wide range of products to meet your lifting, pulling, and rigging needs. Years of engineering know-how, dedication to superior manufacturing, and valued customer input have led to the design and continuous refinement of each Coffing product.

When you buy a Coffing hoist, you get performance you can count on. We back every hoist with a lifetime warranty no one else can match. Our promise is that Coffing hoists will work longer and harder because we build them to last.

Experience, dedication, service, superior design and manufacturing—that's what *High Performance Lifting* is all about.



CONTENTS

Powered Hoists

EC — Cutaway View	4, 5
EC — Features	6, 7
EC — Hook & Lug Mount	8, 9
EC — Trolley Mount	10, 11
EC — Extended Duty Model	12
EC — Turnover Model	13
MT — Motorized Trolley	14
ELC — Features	15
ELC — Hook & Lug Mount	16
ELC — Trolley Mount	17
EMC & EMW Models	18
ESC Model	19
AC Model	20
TMM Model	21
Accessories—Powered Products	22-26
Special Applications for EC Models	27
How to Specify Electric Chain Models	27
Bridge Crane Kits	28

Hand Chain Hoists

LHH Model	29
CA, CB, CTH Models & Features	30, 31
AT Model	32
YLH Model	33
Chain Containers — Hand Chain	35

Trolleys and Beam Clamps

MT — Motorized Trolley	14
ET-A, CT, CY — Manual Trolleys	34-36
BC — Beam Clamps	34

Ratchet Lever Hoists

Features	37
LSB-A Model	38
PA Model	39
MA & MAL Models	40
RA Model	41
G Series Model	42
Cable Model	43
A & AD Models	44

I-Beam Specifications	46
Warranty	47

For information regarding dimensional drawings, please refer to page 44
For information regarding Coffing Wire Rope products, please refer to page 45

Electric Chain Hoist

1/4 to 5 Ton Models

Electrical Cover —

Quick removal for easy access to motor and all electrical connections.

Hoist Motor —

High torque, H4 duty class motor with class F insulation. Two-speed motors available. 60 hertz standard, 50 hertz available.

Suspension —

Easily changed from hook to lug, for use with plain, geared, or motorized trolley.

Chain Guide —

Resists jamming and keeps chain aligned with load sheave.

Internal Strain Relief —

Provides support for push button station.

Ergonomic Push Button Control

Constructed from glass-filled nylon for severe impact and chemical/corrosive atmosphere resistance. Our push button station fits operator's hand for thumb or two-handed operation. 24 Volt Control standard for operator safety. 115 Volt Control available upon request. NEMA 3R (weather resistant) standard.

Load Blocks —

Double and triple chain models equipped with grease fitting in bottom block.

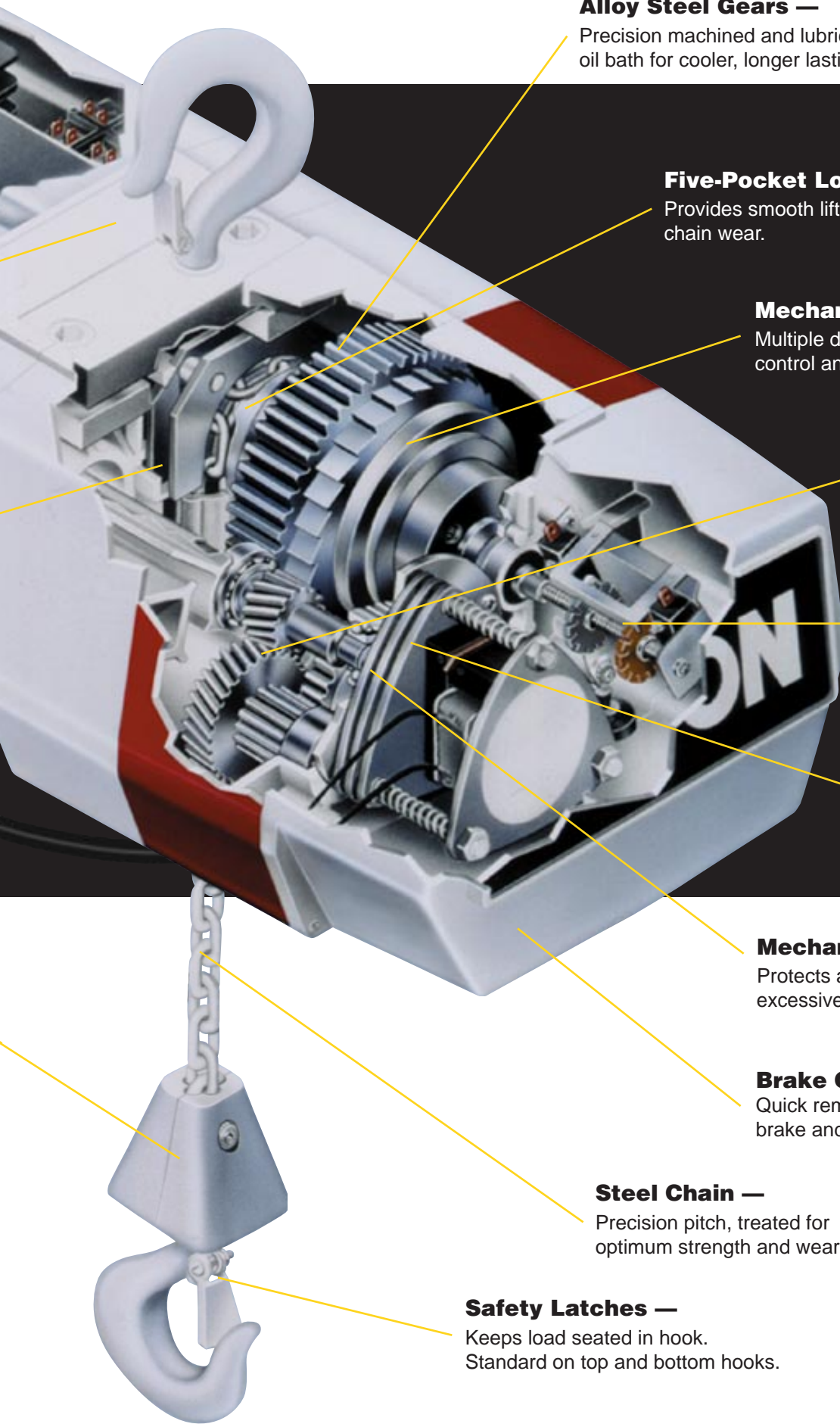

Alloy Steel Gears —

Precision machined and lubricated in oil bath for cooler, longer lasting operation.

Five-Pocket Load Sheave —

Provides smooth lifting and reduces chain wear.

Mechanical Load Brake —

Multiple disc type for load lowering control and added safety.

Helical Gearing —

Quietest operation available.

Limit Switches —

Adjustable upper and lower limit switches to regulate load travel.

Motor Brake —

Multiple disc, direct acting to stop load when push button is released and power off.

Mechanical Overload Device —

Protects against damage caused by excessive overloads and reverse phasing.

Brake Cover —

Quick removal for easy access to brake and limit switch.

Steel Chain —

Precision pitch, treated for optimum strength and wear resistance.

Safety Latches —

Keeps load seated in hook. Standard on top and bottom hooks.

COFFING[®]
HOISTS

High Performance Lifting™

FEATURES

EC MODELS Electric Chain Hoists



Mechanical Load Brake

Weston type, controls load lowering and prevents load drift. Holds rated load independent of multiple disc motor brake.

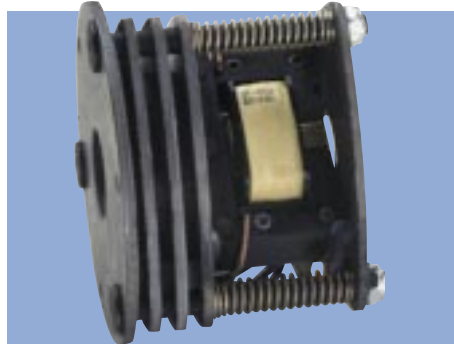

Multiple Disc Motor Brake

Heavy duty, direct acting design for positive load spotting and holding.



Ergonomic Designed Push Button Station

Fits operator's hand for thumb or two-handed operation. 24 Volt Control standard for operator safety. 115 Volt Control available upon request. NEMA 3R (weather resistant). Constructed of glass-filled nylon for severe impact and chemical/corrosive atmosphere resistance.



Five-Pocket Load Sheave

Increases chain and sheave engagement 25% over hoists with conventional four-pocket sheaves. Provides smoother lifting and reduces chain wear over four-pocket sheaves.

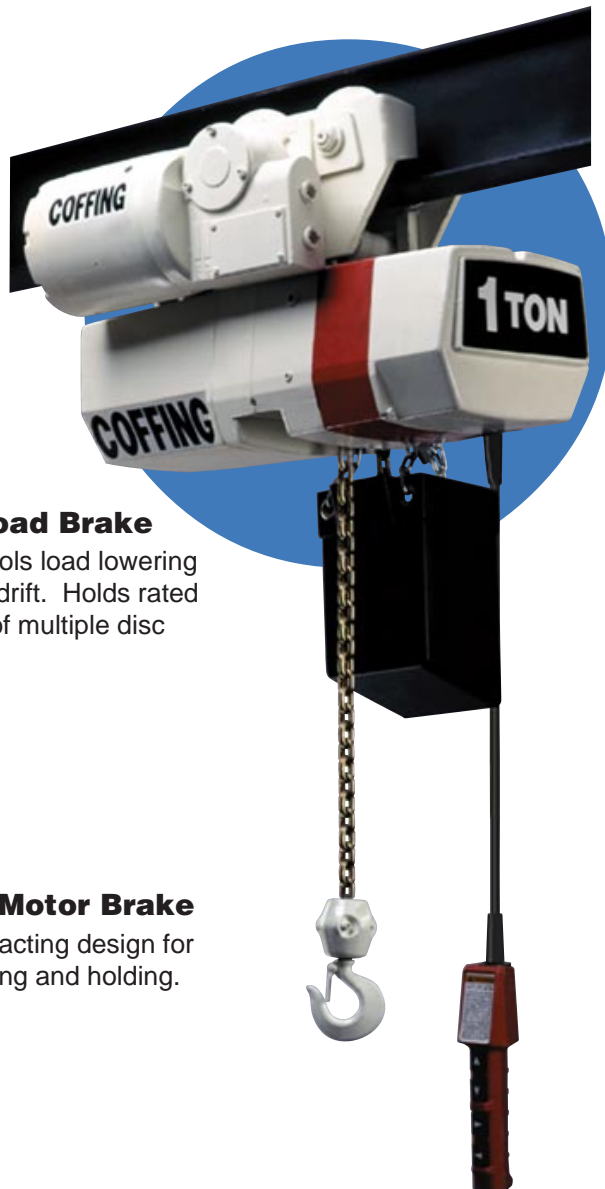
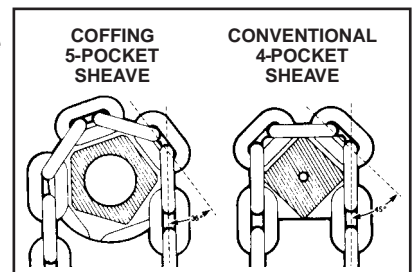

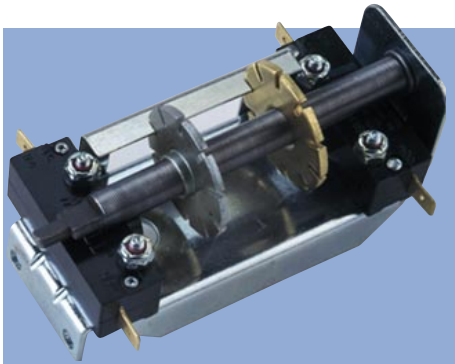

Limit Switches

Adjustable to regulate upper and lower load travel. Brass nuts standard for improved switch setting and repeatability. Stainless steel limit switch shaft standard.



Solid State Starting Switch

Standard on single phase units. Provides greater reliability and starting consistency than centrifugal switches - fewer components to wear out or fail.



Panel Plate

Provides easy access to controls and motor leads for changing voltage on dual-voltage motors or performing hoist maintenance. Connection wires are numbered to assist maintenance or repair.

COFFING[®] HOISTS

EC MODELS



Chain End Stop Assembly

Fits below dead end link on lifting chain for added measure of safety.



Overload Clutch

Protects hoist, operator, and supporting structures from damaging overloads, chain jamming, and reverse phasing.



Gearing and Transmission

First stage helical gearing on EC small frame; first and third stage helical gearing on EC large frame. Transmission gears are precision machined of alloy steel and run in oil bath for longer, quieter operation.

The Industry Leader—Strength & Dependability

EC Hook & Lug Suspension Models

COFFING EC Models - *High performance* hoists engineered for heavy duty industrial service. Designed for safety, the EC incorporates mechanical load brake, motor brake, and overload clutch as standard.

- **CAPACITIES & LIFTS** - Rated loads from 1/4 to 5 Tons, with 10, 15, and 20-foot standard lifts. Other lifts available. Standard push button drop is 4-feet less than lift.
- **VOLTAGE & MOTOR OPTIONS** - 115/230, 208 - single phase; 230/460, 208, 220/380, 575 - three phase. 60 hertz standard, 50 hertz available. Two-speed motors available (3 to 1 speed ratio).
- **SUSPENSION OPTIONS** - Rigid or swivel top hook, lug, plain, geared, and motorized trolley available.
- **STANDARD FEATURES** - Refer to pages 6 & 7.
- **SMALL FRAME DESIGN** - Features housings of cast aluminum alloy construction for minimum weight. Engineered and designed for use with motors up to 1 HP.
- **LARGE FRAME DESIGN** - Features load bearing housings of ductile iron construction for maximum strength. Non-load bearing housings of cast aluminum alloy for minimum weight. Engineered and designed for use with higher torque 2 and 3 HP three phase motors
- **DURABLE CONSTRUCTION** - Built in compliance with ASME/ANSI B30.16 and CSA standards.
- **ACCESSORIES & OPTIONS** - Full line available to meet a variety of applications. See pages 22-27.
- **LIFETIME WARRANTY**



1/4 - 5 Ton
Made in USA

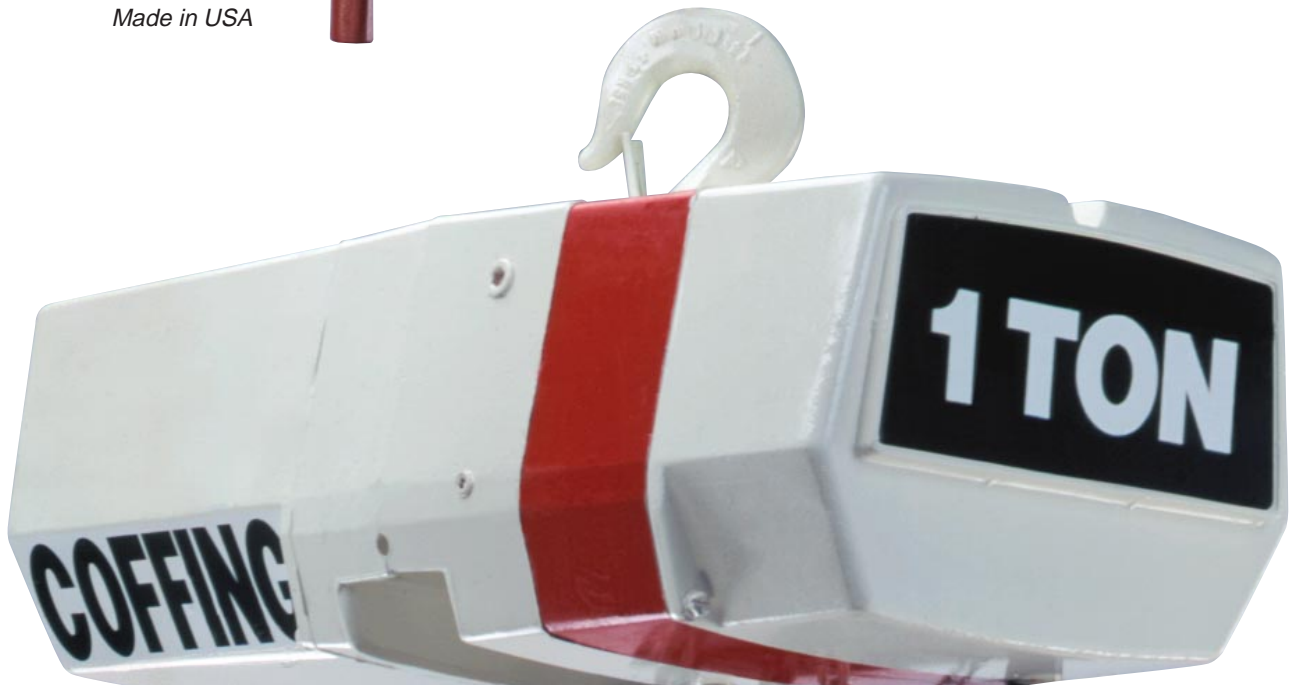

SPECIFICATIONS

EC Hook & Lug Suspension Models

Capacity		Model Number	Frame* Size	No. of Chains	Motor HP	Lift Speed (FPM)		Headroom (In.)	Housing Dimensions (In.)			Net Wt.** (Lb.)
(Lb.)	(Ton)					Single	Two		H	W	L	
500	1/4	EC-0516	S	1	1/4	16	5.3	16 ⁷ / ₈	8	11 ⁵ / ₈	23 ³ / ₈	100
500	1/4	EC-0532	S	1	1/2	32	10.7	16 ⁷ / ₈	8	11 ⁵ / ₈	23 ³ / ₈	108
500	1/4	EC-0564	S	1	1	64	21.3	16 ⁷ / ₈	8	11 ⁵ / ₈	23 ³ / ₈	116
1000	1/2	EC-1009	S	1	1/4	9	3	16 ⁷ / ₈	8	11 ⁵ / ₈	23 ³ / ₈	104
1000	1/2	EC-1016	S	1	1/2	16	5.3	16 ⁷ / ₈	8	11 ⁵ / ₈	23 ³ / ₈	106
1000	1/2	EC-1032	S	1	1	32	10.7	16 ⁷ / ₈	8	11 ⁵ / ₈	23 ³ / ₈	118
2000	1	EC-2004	S	2	1/4	4	1.3	18 ¹ / ₄	8	11 ⁵ / ₈	23 ³ / ₈	116
2000	1	EC-2008	S	2	1/2	8	2.7	18 ¹ / ₄	8	11 ⁵ / ₈	23 ³ / ₈	116
2000	1	EC-2012	S	1	3/4	12	4	16 ⁷ / ₈	8	11 ⁵ / ₈	23 ³ / ₈	114
2000	1	EC-2016	S	1	1	16	5.3	16 ⁷ / ₈	8	11 ⁵ / ₈	23 ³ / ₈	118
2000	1	EC-2032	L	1	2	32	10.7	23	10 ⁷ / ₈	14 ¹³ / ₁₆	31 ³ / ₁₆	295
4000	2	EC-4006	S	2	3/4	6	2	18 ¹⁵ / ₁₆	8	11 ⁵ / ₈	23 ³ / ₈	127
4000	2	EC-4008	S	2	1	8	2.7	18 ¹⁵ / ₁₆	8	11 ⁵ / ₈	23 ³ / ₈	133
4000	2	EC-4016	L	1	2	16	5.3	23	10 ⁷ / ₈	14 ¹³ / ₁₆	31 ³ / ₁₆	295
4000	2	EC-4024	L	1	3	24	8	23	10 ⁷ / ₈	14 ¹³ / ₁₆	31 ³ / ₁₆	302
6000	3	EC-6005	S	3	1	5	1.7	23 ¹ / ₄	8	12	26 ³ / ₈	200
6000	3	EC-6010	L	2	2	10	3.3	27 ³ / ₈	10 ⁷ / ₈	14 ¹³ / ₁₆	31 ³ / ₁₆	340
6000	3	EC-6016	L	2	3	16	5.3	27 ³ / ₈	10 ⁷ / ₈	14 ¹³ / ₁₆	31 ³ / ₁₆	347
8000	4	EC-8008	L	2	2	8	2.7	27 ³ / ₈	10 ⁷ / ₈	14 ¹³ / ₁₆	31 ³ / ₁₆	345
8000	4	EC-8012	L	2	3	12	4	27 ³ / ₈	10 ⁷ / ₈	14 ¹³ / ₁₆	31 ³ / ₁₆	352
10000	5	EC-10005	L	3	2	5	1.7	27 ⁷ / ₈	10 ⁷ / ₈	14 ¹³ / ₁₆	31 ³ / ₁₆	393
10000	5	EC-10008	L	3	3	8	2.7	27 ⁷ / ₈	10 ⁷ / ₈	14 ¹³ / ₁₆	31 ³ / ₁₆	393

* **S** = Small frame hoist, parallel mounted, single or three phase. **L** = Large frame hoist, cross mounted, three phase only.
 ** For 10 ft. lift, top hook suspension and lug suspension units.

NOTE: For complete dimensional data, refer to Coffing Dimensional Databook.

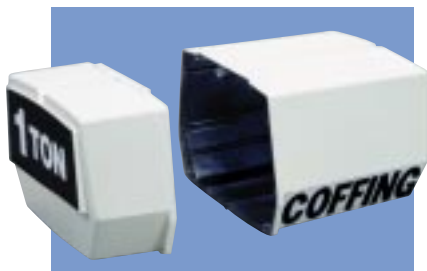

Housing Design

Brake cover (left) and electrical cover (right) easily removed for maintenance or service of unit. (Covers for EC Small Frame Unit Shown)



Suspensions For A Variety of Applications



1/4 - 5 Ton
Made in USA

EC Trolley Suspensions

COFFING ECT, ECGT, and ECMT Models - Plain, geared, and motorized trolley suspensions with all the features of basic EC models for added flexibility in a variety of applications.

- **PLAIN TROLLEY** - For manual positioning of hoist and load.
- **GEARED TROLLEY** - For more precise positioning of hoist and load. Standard hand chain drop is 2-feet less than lift.
- **MOTORIZED TROLLEY** - For faster positioning of hoist and load over longer distances. 35 or 75 FPM speeds standard with optional speeds of 18, 24, 50, 100, and 150 FPM.
- **VOLTAGES** - 115/230, 208 - single phase; 230/460, 208, 220/380, 575 - three phase. 60 hertz standard, 50 hertz available.
- **TWO-SPEED MOTORIZED TROLLEY MODELS** - Optional with 3 to 1 speed ratio, three-phase, single voltage only.
- **WRAP-AROUND SIDE PLATES** - Act as safety lugs and as bumpers to protect wheels. Available to fit American Standard I-Beams, wide-flange, and patented track beams. Specify track type and beam size.
- **PRECISION TROLLEY WHEELS** - Machined, cast iron wheels with sealed, lifetime lubricated ball bearings for extended trolley life. Motorized trolley wheels heat treated for added durability. Bronze and stainless steel wheels optional.
- **TWO TROLLEY DESIGNS** - 4-wheel design on 1/4 - 3 ton negotiates 48" minimum radius curve, including patented track applications. 8-wheel design on 4 and 5 ton reduces beam flange stress.
- **ACCESSORIES & OPTIONS** - Full line available to meet a variety of applications. See pages 22-27.
- **LIFETIME WARRANTY**



SPECIFICATIONS

EC Plain, Geared & Motorized Suspensions

Capacity		Model Number	Frame* Size	Trolley† Mount	ECT & ECGT Hdrm (In.)	ECMT Hdrm (In.)	Flange Width (In.)	Beam Ht. (In.)	Min. Rad. Curve (In.)	Net Wt.** (Lb.)	ECMT Net Wt. (Lb.)
(Lb.)	(Ton)										
500	1/4	EC(†)-0516	S	P	17 ¹ / ₄	17 ¹ / ₄	3.332 - 6	6 - 18	48	145	180
500	1/4	EC(†)-0532	S	P	17 ¹ / ₄	17 ¹ / ₄	3.332 - 6	6 - 18	48	153	188
500	1/4	EC(†)-0564	S	P	17 ¹ / ₄	17 ¹ / ₄	3.332 - 6	6 - 18	48	161	196
1000	1/2	EC(†)-1009	S	P	17 ¹ / ₄	17 ¹ / ₄	3.332 - 6	6 - 18	48	151	186
1000	1/2	EC(†)-1016	S	P	17 ¹ / ₄	17 ¹ / ₄	3.332 - 6	6 - 18	48	151	186
1000	1/2	EC(†)-1032	S	P	17 ¹ / ₄	17 ¹ / ₄	3.332 - 6	6 - 18	48	163	198
2000	1	EC(†)-2004	S	P	18 ⁵ / ₈	18 ⁵ / ₈	3.332 - 6	6 - 18	48	161	196
2000	1	EC(†)-2008	S	P	18 ⁵ / ₈	18 ⁵ / ₈	3.332 - 6	6 - 18	48	161	196
2000	1	EC(†)-2012	S	P	17 ¹ / ₄	17 ¹ / ₄	3.332 - 6	6 - 18	48	158	194
2000	1	EC(†)-2016	S	P	17 ¹ / ₄	17 ¹ / ₄	3.332 - 6	6 - 18	48	163	198
2000	1	EC(†)-2032	L	C	21 ⁹ / ₁₆	22 ¹ / ₄	3.332 - 6	6 - 18	48	347	375
4000	2	EC(†)-4006	S	P	19 ⁵ / ₁₆	19 ⁵ / ₁₆	3.332 - 6	6 - 18	48	172	207
4000	2	EC(†)-4008	S	P	19 ⁵ / ₁₆	19 ⁵ / ₁₆	3.332 - 6	6 - 18	48	178	213
4000	2	EC(†)-4016	L	C	21 ⁹ / ₁₆	22 ¹ / ₄	3.332 - 6	6 - 18	48	347	375
4000	2	EC(†)-4024	L	C	21 ⁹ / ₁₆	22 ¹ / ₄	3.332 - 6	6 - 18	48	354	362
6000	3	EC(†)-6005	S	P	23 ¹ / ₄	24	3.332 - 6	6 - 18	48	260	320
6000	3	EC(†)-6010	L	C	26	26 ⁵ / ₈	3.332 - 6	6 - 18	48	396	424
6000	3	EC(†)-6016	L	C	26	26 ⁵ / ₈	3.332 - 6	6 - 18	48	403	431
8000	4	EC(†)-8008	L	C	25 ¹⁵ / ₁₆	26 ³ / ₄	4 - 6	8 - 18	***	520	560
8000	4	EC(†)-8012	L	C	25 ¹⁵ / ₁₆	26 ³ / ₄	4 - 6	8 - 18	***	527	567
10000	5	EC(†)-10005	L	C	29 ³ / ₄	30 ⁵ / ₈	4 - 6	8 - 18	***	561	599
10000	5	EC(†)-10008	L	C	29 ³ / ₄	30 ⁵ / ₈	4 - 6	8 - 18	***	568	606

† Specify **ECT** for plain trolley, **ECGT** for geared trolley, and **ECMT** for motorized trolley models.

* **S** = Small frame hoist, single or three phase. **L** = Large frame hoist, three phase only.

‡ **P** = Parallel mount, standard on small frame hoists. **C** = Cross mount, standard on large frame hoists.

** Weight for 10 ft. lift ECT units. Add 10 lb. for ECGT unit weights.

*** 4 & 5 ton straight track only. Articulated model for 48" min. radius curved track available — consult factory.

NOTE: For complete dimensional data, refer to Coffing Dimensional Databook.



EC Hoists For Special Applications

Extended Duty Hoists

COFFING ED Models - Extended duty service for special applications which require a hoist that exceeds the duty rating of basic EC models.

- **CAPACITIES & LIFTS** - Rated loads from 1/4 to 2 Tons, with 10, 15, and 20-foot standard lifts. Other lifts available. Standard push button drop is 4-feet less than lift.
- **VOLTAGE & MOTOR OPTIONS** - 230/460, three phase motors standard. Totally enclosed, fan-cooled motor keeps both motor and transmission from overheating. Consult factory for other voltage and speed options.
- **SUSPENSION OPTIONS** - Rigid lug; plain, geared, and motorized trolleys.
- **DUTY CYCLE** - Exceeds H4 duty service.
- **LOAD CHAIN** - Zinc plated standard for corrosion resistance.
- **EXTERNAL STRAIN RELIEF** - Secures to NEMA 3R push button station with extra strain relief protection.
- **ACCESSORIES** - Full line of options to meet a variety of applications. See pages 22-27.
- **LIFETIME WARRANTY**



1/2 - 2 Ton
Made in USA

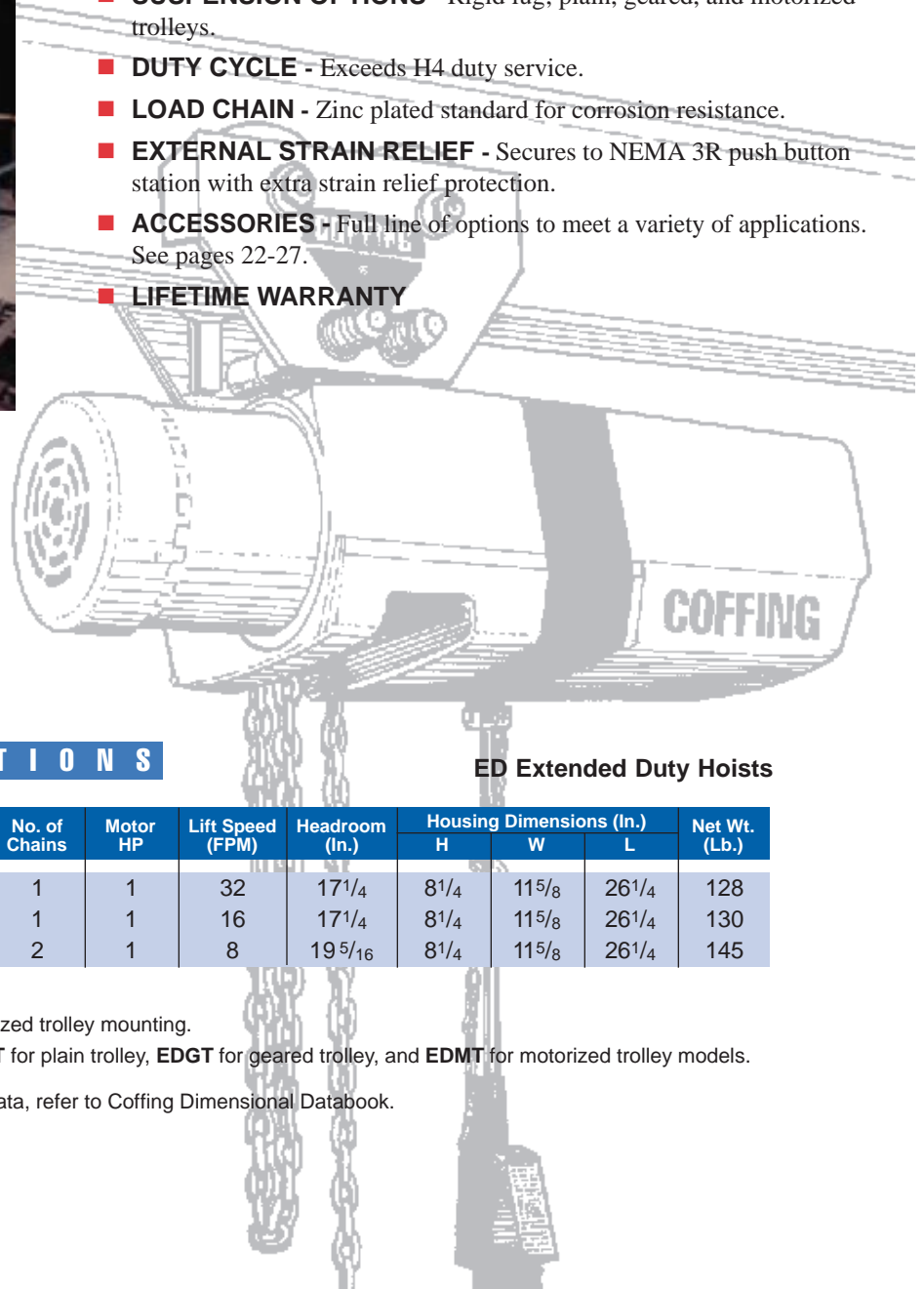

S P E C I F I C A T I O N S

ED Extended Duty Hoists

Capacity		Model* Number	No. of Chains	Motor HP	Lift Speed (FPM)	Headroom (In.)	Housing Dimensions (In.)			Net Wt. (Lb.)
(Lb.)	(Ton)						H	W	L	
1000	1/2	ED(†)-1032	1	1	32	17 1/4	8 1/4	11 5/8	26 1/4	128
2000	1	ED(†)-2016	1	1	16	17 1/4	8 1/4	11 5/8	26 1/4	130
4000	2	ED(†)-4008	2	1	8	19 5/16	8 1/4	11 5/8	26 1/4	145

* Lug, plain, geared, or motorized trolley mounting.

† Specify **ED** for rigid lug, **EDT** for plain trolley, **EDGT** for geared trolley, and **EDMT** for motorized trolley models.

NOTE: For complete dimensional data, refer to Coffing Dimensional Databook.

EC Hoists For Special Applications

Turnover Hoists

COFFING EC Turnover Models - Specially modified EC hoist designed for machining, assembly, or repair applications which require complete rotation and/or precise positioning of large, non-symmetrical work pieces.

- **CAPACITIES & LIFTS** - Rated loads from 1/4 to 4 Tons. Lift stroke is 15-foot standard. Consult factory for longer lift strokes.
- **VOLTAGE** - 230/460, three phase motors standard. Consult factory for other voltages and two speed motors.
- **SUSPENSION OPTIONS** - Rigid lug mount only. Allows attachment to load hook of another hoist for vertical lifting.
- **TWO LOAD HOOKS** - Color coded load hooks with corresponding push button for operator convenience.
- **OPERATION** - Load hooks operate in opposite directions.
- **APPLICATION** - Completely inverts virtually any shape load with use of simple slings and successive repositioning of load hooks.
- **ACCESSORIES** - Full line of options to meet a variety of applications. See pages 22-27.
- **LIFETIME WARRANTY**



1/4 - 4 Ton
Made in USA

TYPICAL APPLICATION

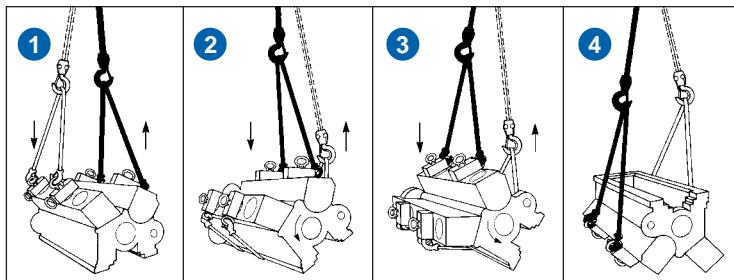

Engine block is raised straight up (1) by special cylinder lift rings, then rotated approximately 45° until one load hook (2) supports total weight.

Sling is guided under block and attached to free hook (3). Hoist is then reversed (4) until block is inverted.

SPECIFICATIONS

EC Turnover Hoists

Capacity		Model Number	Frame* Size	Load Chain Length (Ft.)	Lift Stroke (Ft.)	Motor HP	Lift Speed (FPM)	Headroom (In.)	Housing Dimensions (In.)			Net Wt. (Lb.)
(Lb.)	(Ton)								H	W	L	
500	1/4	EC-0516-TH	S	16	15	1/4	16	197/8	97/8	115/8	233/8	120
1000	1/2	EC-1016-TH	S	16	15	1/2	16	197/8	97/8	115/8	233/8	126
2000	1	EC-2016-TH	S	16	15	1	16	197/8	97/8	115/8	233/8	138
4000	2	EC-4016-TH	L	16	15	2	16	28 1/2	12 5/16	14 13/16	31 3/16	325
6000	3	EC-6008-TH	L	34**	15	3	8	33	13 5/16	15 3/8	31 3/16	385
8000	4	EC-8008-TH	L	34**	15	3	8	33	13 5/16	15 3/8	31 3/16	390

* S = Small frame hoist, single or three phase. L = Large frame hoist, three phase only.

** Each load block is double-chained on 6000 lb. and 8000 lb. models.

NOTE: For complete dimensional data, refer to Coffing Dimensional Databook.

Smooth, Reliable Operation

MT Motorized Trolley



1/4 - 5 Ton
Made in USA

COFFING MT Model Trolley - Features rugged construction with wrap-around side plates and heat treated wheels for reliable service. Universal clevis allows quick mounting of most hook mounted electric chain hoists.

- **CAPACITIES** - Rated loads from 1/4 to 5 Tons. Push button drop is 6-feet.
- **VOLTAGES** - 115/230, 208 - single phase; 230/460, 208, 220/380, 575 - three phase. 60 hertz standard, 50 hertz available.
- **SPEEDS** - 35 and 75 FPM speeds standard with optional speeds of 18, 24, 50, 100, and 150 FPM.
- **TWO-SPEED MODELS** - Optional with 3 to 1 speed ratio, three-phase, single voltage only. Slow speed feature for gentler start and greater positioning accuracy.
- **MOUNTING** - Universal clevis will accept top hook models. Can change EC and ELC suspensions to lug mount directly to MT trolley — consult factory.
- **TROLLEY DESIGN** - 4-wheel design on 1/4 - 3 Ton and under. 8-wheel design on 4 and 5-Ton for reduced beam flange stresses. Specify track type and beam size.
- **NEMA 3R PUSH BUTTON** - Ergonomic design fits operator's hand for thumb or two-handed operation. 24 Volt Control standard for operator safety. 115 Volt Control available upon request.
- **ACCESSORIES** - Trolley brake and other options available to meet a variety of applications.
- **LIFETIME WARRANTY**

SPECIFICATIONS

MT Electric Trolleys

Capacity		Model Number	Motor HP	Flange Width (In.)	Beam Ht. (In.)	Min. Rad. Curve (In.)	Net Wt. (Lb.)
(Lb.)	(Ton)						
500	1/4	MT-05035	1/4	3.332 - 6	6 - 18	48	115
500	1/4	MT-05075	1/4	3.332 - 6	6 - 18	48	115
1000	1/2	MT-10035	1/4	3.332 - 6	6 - 18	48	115
1000	1/2	MT-10075	1/4	3.332 - 6	6 - 18	48	115
2000	1	MT-20035	1/4	3.332 - 6	6 - 18	48	115
2000	1	MT-20075	1/4	3.332 - 6	6 - 18	48	115
3000	1 1/2	MT-30035	1/4	3.332 - 6	6 - 18	48	115
3000	1 1/2	MT-30075	1/4	3.332 - 6	6 - 18	48	115
4000	2	MT-40035	1/4	3.332 - 6	6 - 18	48	115
4000	2	MT-40075	1/2	3.332 - 6	6 - 18	48	115
6000	3	MT-60035	1/4	3.332 - 6	6 - 18	48	115
6000	3	MT-60075	1/2	3.332 - 6	6 - 18	48	115
8000	4	MT-80035	(2) 1/4	4 - 6	8 - 18	***	220
8000	4	MT-80075	(2) 1/2	4 - 6	8 - 18	***	220
10000	5	MT-100035	(2) 1/4	4 - 6	8 - 18	***	220
10000	5	MT-100075	(2) 1/2	4 - 6	8 - 18	***	220

*** 4 & 5 Ton - straight track only. Articulated model for 48" min. radius curved track available — consult factory.

NOTE: For complete dimensional data, refer to Coffing Dimensional Databook.

FEATURES

ELC Models

Electric Chain Hoists



Solid State Starting Switch

Standard on single phase units. Provides greater reliability and starting consistency than centrifugal switches - fewer components to wear out or fail.



Five-Pocket Load Sheave

Increases chain and sheave engagement 25% over hoists with conventional four-pocket sheaves. Provides smoother lifting and reduces chain wear.



Multiple Disc Motor Brake

Heavy duty design for reliable, safe operation. Direct acting for positive load holding and spotting.



Universal Lug

Precision machined from heat treated steel for mounting plain trolley (ET-A 1 & 2 ton models) and motorized trolley (MT) suspensions.



TENV Hoist Motor

Totally enclosed, non-ventilated, high torque, H4 duty class motor with class F insulation. Two-speed motors available.



Mechanical Overload Protection Device

Protects hoist, operator, and supporting structures from damaging overloads, chain jamming & reverse phasing.



Ergonomic Push Button Station

Fits operator's hand for thumb or two-handed operation. 24 Volt Control for operator safety. 115 Volt Control available upon request.



Chain End Stop Assembly

Fits below dead end link on lifting chain for added measure of safety.

The Choice For Value and Performance

ELC Top Hook and Lug Suspension



1/8 - 2 Ton
Made in USA

- **COFFING ELC Models** - Designed for industrial duty performance. Compact in size, the ELC features a multiple disc motor brake, overload clutch, and chain end stop for safety.
- **CAPACITIES & LIFTS** - Rated loads from 1/8 to 2 Tons, with 10, 15, and 20-foot standard lifts. Other lifts available. Standard push button drop is 4-feet less than lift.
- **VOLTAGES** - 115/230 - single phase; 230/460, 208, 380, 415, 575 - three phase, 60 hertz standard, 50 hertz available.
- **TWO-SPEED HOIST MODELS** - Optional with 3 to 1 speed ratio, three-phase, single voltage only.
- **STANDARD FEATURES** - See page 15.
- **LIMIT SWITCHES** - Adjustable to regulate upper and lower load travel. Brass nuts standard for improved repeatability and chain positioning.
- **OIL BATH TRANSMISSION** - Precision machined alloy steel gears run in oil bath for longer, quieter operation.
- **NEMA 3R PUSH BUTTON STATION** - Ergonomic design fits operator's hand for thumb or two-handed operation. 24 Volt Control for operator safety. 115 Volt Control available upon request.
- **FRAME** - Compact aluminum housing for portability and ease of installation.
- **ACCESSORIES** - See pages 22-25.
- **LIFETIME WARRANTY**

SPECIFICATIONS

ELC Top Hook and Lug Suspension

Capacity		Model Number	No. of Chains	Motor HP	Lift Speed (FPM)		Headroom* (In.)	Housing Dimensions (In.)			Net Wt.** (Lb.)
(Lb.)	(Ton)				Single	Two		H	W	L	
250	1/8	ELC-0232	1	1/4	32	10.7	18	8 ³ / ₈	7 ¹⁵ / ₁₆	21 ³ / ₈	62
500	1/4	ELC-0516	1	1/4	16	5.3	18	8 ³ / ₈	7 ¹⁵ / ₁₆	21 ³ / ₈	62
500	1/4	ELC-0532	1	1/2	32	10.7	18	8 ³ / ₈	7 ¹⁵ / ₁₆	21 ¹ / ₄	74
1000	1/2	ELC-1016	1	1/2	16	5.3	18	8 ³ / ₈	7 ¹⁵ / ₁₆	21 ¹ / ₄	74
1000	1/2	ELC-1032	1	1	32	10.7	18	8 ³ / ₈	7 ¹⁵ / ₁₆	22 ³ / ₄	87
2000	1	ELC-2016	1	1	16	5.3	18	8 ³ / ₈	7 ¹⁵ / ₁₆	22 ³ / ₄	89
4000	2	ELC-4008	2	1	8	2.7	21 ³ / ₄	8 ³ / ₈	7 ¹⁵ / ₁₆	22 ³ / ₄	99

* For hook and lug mounted models only.

** Weight and dimensions for 10 ft. lift, single phase, top hook and lug suspension units.

NOTE: For complete dimensional data, refer to Coffing Dimensional Databook.

Motorized and Plain Trolley Applications

ELC Trolley Suspensions

COFFING ELCET and ELCMT Models - Plain and motorized trolley suspensions with all the features of the basic ELC models for added flexibility in a variety of applications.

- **PLAIN TROLLEY** - For manual positioning of hoist and load.
- **MOTORIZED TROLLEY** - For faster positioning of hoist and load over longer distances. 35 or 75 FPM speeds standard- other speeds available. Trolley brake optional.
- **VOLTAGES** - 115/230 - single phase; 230/460, 208, 380, 415, 575 - three phase, 60 hertz standard, 50 hertz available.
- **TWO-SPEED MOTORIZED TROLLEY MODELS** - Optional with 3 to 1 speed ratio, three-phase, single voltage only.
- **WRAP-AROUND SIDE PLATES** - Act as safety lugs and as bumpers to protect wheels. Available to fit American Standard I-Beams, wide- flange, and patented track beams.
- **PRECISION TROLLEY WHEELS** - Machined, cast iron wheels with sealed, lifetime lubricated ball bearings for extended trolley life. Motorized trolley wheels are heat treated for added durability, with bronze and stainless steel wheels optional.
- **TROLLEY DESIGN** - 4-wheel design negotiates 48" minimum radius curve, including patented track applications (60" for ELCET 2-Ton only). Specify track type and beam size.
- **LIFETIME WARRANTY**

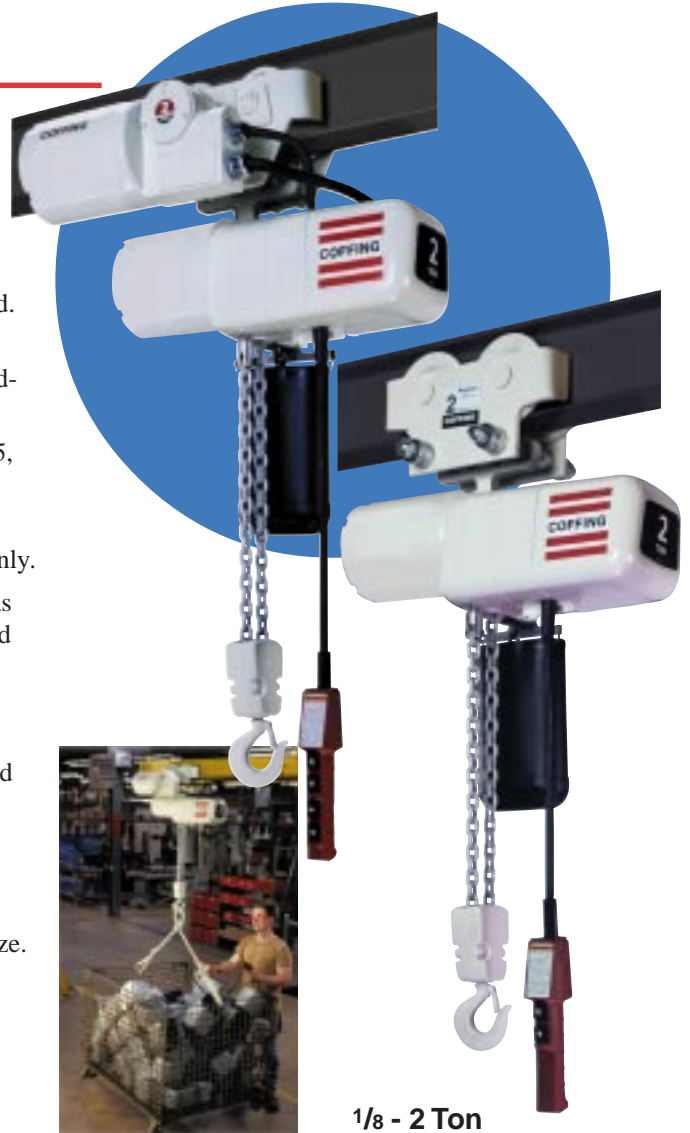

1/8 - 2 Ton
Made in USA

SPECIFICATIONS

ELC Trolley Suspensions

Capacity		Model Number	Trolley ‡ Mount	ELCET Hdrm (In.)	ELCMT Hdrm (In.)	ELCET Flange* Width (In.)	Beam Ht. (In.)	Min. Rad. Curve (In.)	ELCET Net Wt. (Lb.)	ELCMT Net Wt. (Lb.)
(Lb.)	(Ton)									
250	1/8	ELC(†)-0232	P	18 ^{3/4}	19 ^{5/16}	3 - 8	5 - 12	48/48	86	172
500	1/4	ELC(†)-0516	P	18 ^{3/4}	19 ^{5/16}	3 - 8	5 - 12	48/48	86	172
500	1/4	ELC(†)-0532	P	18 ^{3/4}	19 ^{5/16}	3 - 8	5 - 12	48/48	98	184
1000	1/2	ELC(†)-1016	P	18 ^{3/4}	19 ^{5/16}	3 - 8	5 - 12	48/48	98	184
1000	1/2	ELC(†)-1032	P	18 ^{3/4}	19 ^{5/16}	3 - 8	5 - 12	48/48	111	197
2000	1	ELC(†)-2016	P	18 ^{3/4}	19 ^{5/16}	3 - 8	5 - 12	48/48	113	199
4000	2	ELC(†)-4008	P	22 ^{27/32}	23 ^{1/16}	3.33 - 8	6 - 18	60/48	155	209

† Specify **ELCET** for plain trolley and **ELCMT** for motorized trolley models.

‡ P = Parallel mount, standard on all ELC trolley models.

* For **ELCMT** models, standard flange adjustment is 3.33 - 6". Consult factory for special beam size options.

NOTE: For complete dimensional data, refer to Coffing Dimensional Databook.

The Solutions for Light Duty Applications

EMC and EMW Models



300 & 500 Lb.
Made in USA

500 Lb.
Made in USA

COFFING EMC & EMW Models - Compact chain and wire rope hoists designed for a variety of light duty applications. These models feature thermally protected motors.

- **CAPACITIES & LIFT** - Rated loads 300 and 500 pounds. 10-foot lift with 6-foot push button cord standard.
- **VOLTAGES** - 115V, single phase motors only.
- **SUSPENSION** - Swivel top and bottom hooks with safety latches standard.
- **POWER CORD** - Provided with grounded 3-prong plug for easy installation in any standard 115V outlet.
- **ALUMINUM HOUSING**- Lightweight and compact to provide strength and portability. Weighs less than 25 lb.
- **LIMIT SWITCHES** - Upper and lower limit switches on chain models and upper paddle limit switch on wire rope model regulates load travel.
- **ELECTROMAGNETIC BRAKE** - Quick acting for positive load control.
- **THERMAL MOTOR PROTECTION** - Standard to prevent overheating.
- **LIGHT DUTY OPERATION** - Rated for intermittent duty applications (10-minute run time per hour maximum).
- **ACCESSORIES** - LCC-05 chain container (shown) available for EMC models.
- **UL LISTED**
- **LIFETIME WARRANTY**

SPECIFICATIONS

EMC and EMW Models

Capacity (Lb.)	Model Number	No. of Chains	Standard Lift (Ft.)	Motor HP	Lift Speed (FPM)	Headroom (In.)	Housing Dimensions (In.)			Net Wt. (Lb.)
							H	W	L	
300	EMC-300B	1	10	1/6	16	14 1/2	4 3/8	6 3/8	14 1/4	21
500	EMC-500B	2	10	1/6	8	16	4 3/8	6 3/8	14 1/4	24
500	EMW-500B	2-part wire rope	10	1/6	16	13 3/4	4 3/8	6 3/8	14 1/4	19

NOTE: For complete dimensional data, refer to Coffing Dimensional Databook.

Compact & Portable Hoisting Made Easy

ESC Hoist

COFFING ESC Models - Design which includes many safety features you would expect to find in larger, more expensive hoists.

- **CAPACITIES & LIFT** - Rated loads 1/4 and 1/2 Ton. 10 and 20-foot lifts standard. Standard push button is 4-feet less than lift.
- **VOLTAGES** - 115/1-60/50 or 230-1-60 with transformer.
- **SUSPENSION** - Rigid top and swivel bottom hooks with safety latches standard.
- **POWER CORD** - Provided with grounded 3-prong plug for easy installation in any standard 115V outlet.
- **ALUMINUM HOUSING**- Lightweight and compact to provide strength and portability. Weighs less than 25 lb.
- **LIMIT SWITCHES** - Upper and lower limit switches regulate load travel.
- **HELICON™ GEARS** - Hardened steel, self-locking gears work as a brake to hold load even if power is interrupted. Permanent lubrication of gears minimizes maintenance.
- **CHAIN** - Manganese alloy load chain is heat treated for high strength.
- **LOAD SHEAVE** - Heat treated steel alloy load sheave provides smooth lifting.
- **OVERLOAD SENSOR** - Protects hoists against jamming and dangerous overloads. Red light on underside of unit alerts operator if overload is attempted.
- **PUSH BUTTON STATION** - Ergonomic design fits operator's hand for easy operation.
- **LIGHT DUTY OPERATION** - Rated for intermittent duty applications (10-minute run time per hour maximum)
- **LIFETIME WARRANTY**



1/4 & 1/2 Ton
Made in USA

SPECIFICATIONS

ESC Models

Capacity		Model Number	No. of Chains	Standard Lift (Ft.)	Motor HP	Lift Speed (FPM)	Headroom (In.)	Housing Dimensions (In.)			Voltage (1 phase)	Net Wt. (Lb.)
(Lb.)	(Ton)							H	W	L		
500	1/4	ESC-3151	1	10	0.3	12	14 1/4	4 1/4	5 1/4	9 3/4	115V	16
500	1/4	ESC-3167	1	10	0.3	12	14 1/4	4 1/4	5 1/4	9 3/4	230V	26*
500	1/4	ESC-3166	1	20	0.3	12	14 1/4	4 1/4	5 1/4	9 3/4	115V	18
500	1/4	ESC-3168	1	20	0.3	12	14 1/4	4 1/4	5 1/4	9 3/4	230V	28*
1000	1/2	ESC-3152	2	10	0.3	6	14 1/4	4 1/4	5 1/4	9 3/4	115V	20
1000	1/2	ESC-3169	2	10	0.3	6	14 1/4	4 1/4	5 1/4	9 3/4	230V	30*

* Net weight with transformer.

NOTE: For complete dimensional data, refer to Coffing Dimensional Databook.

Continuous Duty — Precise Positioning

AC Model Air Powered Hoist



1/4 - 6 Ton

COFFING AC Models - Air chain hoists featuring continuous duty service for precise, infinitely variable speed and accurate load spotting.

- **CAPACITIES & LIFT** - Rated loads 1/4 to 6 Tons. 10, 15, and 20-foot standard. Other lifts available.
- **CONTROLS** - Standard rope pull cord is 3-feet less than lift. Optional twist rod, lever pendant, and hook-mounted controls available.
- **SUSPENSION** - Swivel top and bottom hooks with safety latches standard. Air trolley available in 3 and 6 tons — consult factory.
- **SPEEDS** - Precise and infinitely variable speed control for accurate load spotting. 90 PSI air operating pressure.
- **COMPACT CONSTRUCTION** - Ideal for use in areas with restricted space. Lightweight and portable - 1/4, 1/2 & 1 ton units weigh less than 50 lbs.
- **MOTOR** - Rotary vane type motor provides for high uniform torque and quick response. Bronze muffler built into valve housing for quiet operation.
- **PLANETARY GEARS** - Designed to withstand continuous operation at full load. Permanently lubricated for long life.
- **DISC TYPE MOTOR BRAKE** - Releases automatically when motor shaft rotates in hoisting direction and sets with slight motor shaft rotation in lowering direction. Designed to eliminate load drift.
- **MAIN VALVE** - Air balanced, spring centered unit provides smooth starts and excellent inching characteristics.
- **LIMIT SWITCHES** - Upper and lower paddle limit switch with plugging to regulate load travel.
- **LIFETIME WARRANTY**

SPECIFICATIONS

AC Model Air Powered Hoists

Capacity		Model Number	No. of Chains	Standard Lifts (Ft.)	Lift Speed (FPM)	Headroom (In.)	Housing Dimensions (In.)			Air Pressure (psi)	Net Wt. (Lb.)
(Lb.)	(Ton)						H	W	L		
500	1/4	AC-0500	1	10, 15, 20	61	14 ^{13/16}	9 ^{1/4}	4 ^{15/16}	15 ^{3/8}	90	37
1000	1/2	AC-1000	1	10, 15, 20	41	14 ^{13/16}	9 ^{1/4}	4 ^{15/16}	15 ^{3/8}	90	37
2000	1	AC-2000	2	10, 15, 20	21 ^{1/2}	17 ^{1/2}	9 ^{1/4}	4 ^{5/8}	15 ^{3/8}	90	46
6000	3	AC-6000	1	10, 15, 20	10 ^{1/2}	22 ^{5/8}	10	8 ^{5/16}	21 ^{1/2}	90	109
12000	6	AC-12000	2	10, 15, 20	5 ^{1/4}	30 ^{7/8}	10	9 ^{13/16}	21 ^{1/2}	90	175

NOTE: For complete dimensional data, refer to Coffing Dimensional Databook.

Air Consumption Data

Note: Speed and air consumption figures should be used only as estimates of hoist performance. Actual data may vary plus or minus 15% because of individual motor characteristics. Do not operate AC hoists at an air pressure of greater than 100 psi. A 1/2" NPT air filter-regulator-lubricator is recommended for optimum operation.

Capacity		Full Load		Half Load	
(Lb.)	(Ton)	(fpm)	(cfm)	(fpm)	(cfm)
500	1/4	61	76	86 ^{1/2}	91
1000	1/2	41	78	71	104
2000	1	21 ^{1/2}	77	35 ^{1/2}	101
6000	3	10 ^{1/2}	84	16	106
12000	6	5 ^{1/4}	84	8	106

The Ideal Workstation Hoist

TMM-140 Air Manipulator Hoist

COFFING TMM-140 Models - The ideal workstation hoist. Lightweight and portable, the unit weighs less than 20 pounds and operates at 100% (A5) duty cycle.

- **CAPACITY** - Rated loads 300 lbs. / 140 kg.
- **SMOOTH OPERATION** - Efficient rotary vane motor provides high uniform torque for quick response and smooth, quiet operation.
- **EASY TO USE** - Handle-mounted pendant control for one-handed operation and load positioning.
- **VARIABLE SPEEDS** - Precise and infinite speed control for accurate load spotting.
- **WIRE ROPE DESIGN** - Self-winding galvanized lifting cable stores conveniently inside unit.
- **SUSPENSION** - Swivel top and bottom hooks with safety latches standard, for portability and quick installation.
- **DISC BRAKE** - Secures load and eliminates drift when pendant is released.
- **NOTE:** A 3/8" NPT air filter-regulator-lubricator is recommended for optimum operation. Spark resistant features are not available.



■ **LIFETIME WARRANTY**
Ideal Applications Include:

- Assembly Lines ■ Machine Shops ■ Cleaning and/or Dipping Operations
- Manufacturing Plants ■ Power Generating Stations ■ Shipping Departments
- Chemical Facilities ■ Fabricating Shops ■ Repetitive Lifting Applications
- Auto and Truck Repair ■ Handling Fixtures and Dies

300 Lb. / 140 Kg.

TMM-140 Air Manipulator Hoists

S P E C I F I C A T I O N S

Capacity (Lb.) (Kg)	Model Number	Std. Lift (Ft.)	Lift Speeds (FPM)				Air Consumption		Headroom (in.)	Housing Dimen. (in.)			Max Air* Pres. (psi)	Net Wt. (Lb.)	
			Load (Up)	(Down)	No Load (Up)	(Down)	(m ³ / min)	(ft ³ / min)		D	W	L			
300	140	TMM-140	6' 6"	36	59	49	39	0.6	21.2	22 3/4	7 2/3	7 7/8	23 3/4	70 - 95	18.7

NOTE: For complete dimensional data, refer to Coffing Dimensional Databook.

ACCESSORIES

Hoist Suspensions

EC Small Frame Suspensions



Standard Top Hook
with safety latch-rigid
(standard) or swivel.



Optional Bullard Hook*
with return latch, with or
without return spring, for
added safety.



Optional Shur-Loc® Hook*
with positive lock latch is self-
locking when hook is loaded.



Optional Multi-Purpose Lug
available for special
applications.



Rigid Lug
for mounting CT and MT
trolleys to small frame
EC models.

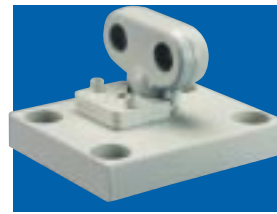

Rigid Lug
for mounting CT and MT
trolleys to EC-6005 model
only.

EC Large Frame Suspensions



Standard Top Hook
with safety latch-rigid
(standard) or swivel.
1, 2, 3, and 4 ton only.



Optional Bullard Hook*
with return latch, with
or without return spring.
1, 2, 3, and 4 ton only.



Optional Shur-Loc® Hook*
with positive lock
latch is self-locking
when hook is loaded.



Rigid Lug
for mounting CT and
MT trolleys to large
frame EC models.
1, 2, and 3 ton only.



Rigid Lug
for mounting CT and
MT trolleys to large
frame EC models.
4 and 5 ton only.

ELC Suspensions



Rigid Top Hook
with safety latch-standard.
Swivel top hook available
on request.



Optional Bullard Hook*
with return latch, with or
without return spring, for
added safety.



Optional Shur-Loc® Hook*
with positive lock latch is
self-locking when hook
is loaded.

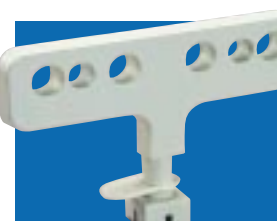

Rigid Lug
for mounting ET, CT,
and MT trolleys.

*Available for top and bottom hook

Chain Containers

- **Models** - To fit EC, ED, and ELC models.
- **Mounting** - Suspends from hoist and does not interfere with hoist operation. Suspension bracket included.
- **Safety** - Recommended where slack chain may create a hazardous condition.

For Small Frame EC Models EC-0516 – EC-4008 (except EC-2032), EC-6005, and all ED Models

Model Number	“Δ” Dimension (In.)	CAPACITY (In Feet Per Hoist Lift)		
		1-Chain Single	2-Chain Double	3-Chain Triple
927JG17	10 ⁷ / ₁₆	20	10	N/A
927JG18	12 ¹ / ₂	25	12.5	N/A
927JG19	16	35	17.5	12
927JG20	20 ¹ / ₄	50	25	17
927JG202A	20	75	37	25
927JG203A	24	100	50	33
927JG204A	35	150	75	50

For Large Frame EC Models EC-2032, EC-4016 – EC-10008 (except EC-6005)

927JG201	16	15	N/A	N/A
927JG202	20	30	15	10
927JG203	24	50	25	16.5
927JG204	35	75	37.5	25
927JG205	48 ³ / ₄	100	50	33.3
927JG207	26	150	75	50
927JG208	32	200	100	66.6

For ELC Models ELC-0232 – ELC-1032

LCC-11	11 ¹ / ₂	26	N/A	N/A
LCC-12	18 ¹ / ₂	42	N/A	N/A
LCC-13	27	54	N/A	N/A

For ELC Models ELC-2016 & ELC-4008

LCC-11	11 ¹ / ₂	20	10	N/A
LCC-12	18 ¹ / ₂	35	17	N/A
LCC-13	27	50	25	N/A



Weather Resistant Covers

- **Models** - To fit EC and ELC models.
- **Material** - Waterproof to protect hoist in outdoor use.
- **Safety** - Does not interfere with normal hoist operation while in place.

For Small Frame EC Models EC-0516 - EC-4008 (except EC-2032)

Hoist Rated Load (Lb.)	Type of Mount	Part Number
500	Hook or Lug	EC-760-1
1000	Hook or Lug	EC-760-2
2000	Hook or Lug	EC-760-3
4000	Hook or Lug	EC-760-4
6000	Not Available	Not Available

For Large Frame EC Models EC-2032, EC4016 - EC-10008 (except EC-6005)

4000	Hook	EC-761-1
4000	Lug	EC-761-2
6000	Hook	EC-761-3
6000	Lug	EC-761-4
8000	Lug	EC-761-5
10000	Lug	EC-761-6



For All ELC Models: Use JF-760

Cord Reels

Electrification Necessary For Electric Chain Hoists

- **Construction** - NEMA 3R all-welded, solid steel construction. UL and CSA listed.
- **Design** - Provides instant availability of power cord and prevents looping and snagging.
- **Ratchet Lock** - Works in any position to hold cord in place and may be disengaged for constant use.
- **Cable Guide** - Multi-position, field adjustable, and removable for different payout configurations.
- **Collector Assembly** - Rated at 600 volts.
- **Optional Pivot Base** - For 340° off-line payout.



Cable Size (AWG)	Model Number	Phase	Active Cable Length (Ft.)
No. 14-3 Conductor	DN-3-25	1	25
No. 14-3 Conductor	DN-3-50	1	50
No. 14-4 Conductor	DN-4-25	3	25
No. 14-4 Conductor	DN-4-45	3	45

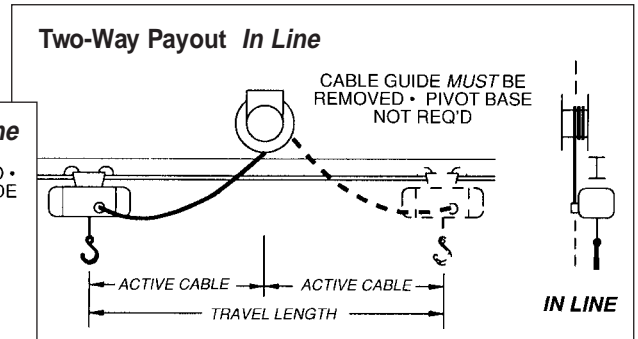
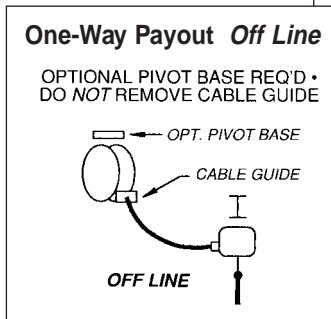
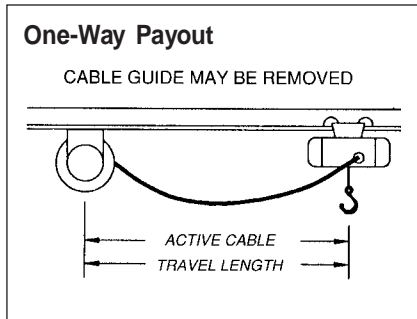

Current Collector Mounting Arm

For Mounting Collectors or Towing Festooning

- **Mounting** - Direct to CT or MT trolleys.
- **One Inch Square Arm** - For use in mounting most makes of collectors or towing festooning.



Torque Reels

Used in Supporting and Suspending Hoist or Crane Push Button Stations

- **Construction** - Steel with reinforced hanging bracket and clevis for ceiling mounting.
- **Ratchet Lock** - Included but easily disengaged from outside housing for constant tension.
- **Optional Rigid Base** - Available for mounting to ceiling, wall, floor, or work bench.

Min - Max Load (Lb.)	Model Number	Cable Length (Ft.)	Reel Weight (Lb.)
5 - 10	6KG319	15	10



Festooning Packages

Economical and Reliable Way to Supply Power to Moving Hoists

- **Flat Cable Kit** - Includes carriers and cable.
- **Round Cable Kit** - Includes carriers but not cable.

Flat Cable Festooning Package

Model Number	Cable Size (Gauge)	Length (Ft.)	Number of Carriers
HEF-12-35	12	35	4
HEF-12-50	12	50	6



Round Cable Festooning Package

Model Number	Length (Ft.)	Number of Carriers
HER - 35	35	4
HER - 50	50	6



Cord Trolleys

Keeps Power Cord from Interfering with Working Area

- **Adjustable** - For standard 3" to 10" American Standard I-Beams.
- **Usage** - One trolley recommended for every 5-feet of power cord.

Adjusts for Std. I-Beam (In.)	Model Number	Tread Diameter (In.)	Net Weight (Lb.)
3 - 10	TL-3-10C	2 3/8	2 1/4

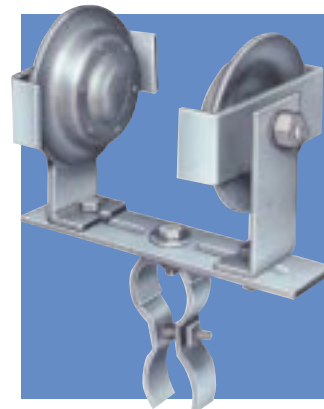



Variable Frequency Drives

Alternative to Conventional Two-Speed Motors

- Consult factory for specific models, features, and benefits.

Remote Control Packages

For Specialized Hoist and Crane Applications

- **Radio and Infrared Models Available** - Consult factory.



Corrosion Resistant Features

Protects Hoist in Corrosive Environments

Consult Factory to Verify Availability on Desired EC Models Only

- **Features** - Zinc plated load chain, zinc plated hand chain, zinc plated hook, stainless steel limit switch shaft, stainless steel wheels, bronze wheels, epoxy paint.



Spark Resistant Features

Reduces Chance of Sparking

Consult Factory to Verify Availability on Desired EC Models Only

- **Features** - Stainless steel load chain, stainless steel hooks, bronze hooks, aluminum hand chain, stainless steel bottom block assembly, stainless steel trolley wheels, bronze trolley wheels, and rubber trolley bumpers.



Additional Features for EC Chain Models

Consult Factory

- Paddle Limit Switch
- Electronic Overload Sensor
- Trolley Limit Switches
- Wall-Mounted Push Button Stations
- NEMA 1, 2, 3R, 4X, 5, 12 & 13 PB Stations
- 3 - Foot Outrigger Arm
- Circuit Breaker
- Motor Fuses
- Mainline Contactor
- Solid State Trolley Soft Start
- Electrical Interlocks
- External Strain Relief
- Electronic Phase Reversal & Under Voltage Protection
- Magnetic Particle Inspection
- Horn or Bell
- Kellems Cord Grip
- Bridge or Tractor Controls
- Track Clamp
- Motor Thermostat
- Thermal Overload Relay
- Trolley Ballast Resistors (3-Phase Only)
- Multi-Button Push Button Stations
- Timers
- Retractable Coil Cord

Special Applications for EC Models

Consult Factory

Tandem Applications

- Twin hooks move long, unwieldy loads.
- Push button control station allows hoists to be operated either simultaneously or individually.
- Hoists connected mechanically or electrically.
- Available with plain, geared, and motorized trolleys.

Twin Hook

- Same as tandem trolley application, except hoist has hook or lug suspension for fixed position operation.

Semi-Automatic

- Requires only a momentary depression of push button to raise or lower hook to preset position.
- Limit switch permits adjustment of end stops anywhere within range of lifts.
- Stop button allows stops between limits.

Multi-Level

- Hoist can be specified with multiple control pendants or wall stations.

Inching Controls

- Selector switch allows hoist operation in normal or jog mode.
- In jog mode, each depression of button advances hook a fraction of an inch. (Field adjustable)
- Can be supplied with jog adjustment potentiometer inside hoist enclosure or on push button station.

Patented Carrier

- Rated load from 1/4 to 3 Tons
- On request, hoist units can be furnished with suitable lugs for mounting on patented track carriers.

Key Lock

- Key lock on push buttons prevent unauthorized hoist use.
- Multiple stations keyed unlike—unless specified.

How to Specify Electric Chain Model Numbers

EC - 05 16 - 1 - 10

MODELS	CAPACITY (Lb.)	LIFT SPEED	VOLTAGE	LIFT
EC Electric Chain, Hook Mounted	02 250	04 4 FPM	1 115/230 V (Single-Speed)	10 10 Ft.
ELC Electric Chain, Hook Mounted	05 500	05 5 FPM	2 230 V (Two-Speed)	15 15 Ft.
ECT Electric Chain, w/ Plain Trolley	10 1000	06 6 FPM	3 230/460 V (Single-Speed)	20 20 Ft.
ELCET Electric Chain, w/ Plain Trolley	20 2000	08 8 FPM	4 460 V (Two-Speed)	25 25 Ft.
ECGT Electric Chain, w/ Geared Trolley	40 4000	09 9 FPM	5 575 V (Single-Speed)	30 30 Ft.
ECMT Electric Chain, w/ Motorized Trolley	60 6000	10 10 FPM	6 575 V (Two-Speed)	35 35 Ft.
ELCMT Electric Chain, w/ Motorized Trolley	80 8000	12 12 FPM	7 208 V (Single-Speed)	40 40 Ft.
ED Extended Duty, Lug Mounted	100 10000	16 16 FPM	8 208 V (Two-Speed)	45 45 Ft.
EDT Extended Duty, w/ Plain Trolley		24 24 FPM		Etc.
EDGT Extended Duty w/ Geared Trolley		32 32 FPM		
EDMT Extended Duty w/ Motorized Trolley		64 64 FPM		

Consult factory for special voltages

Bridge Crane Kits

Features Push Type End Trucks and Hardware Kit to Mount Span Beam

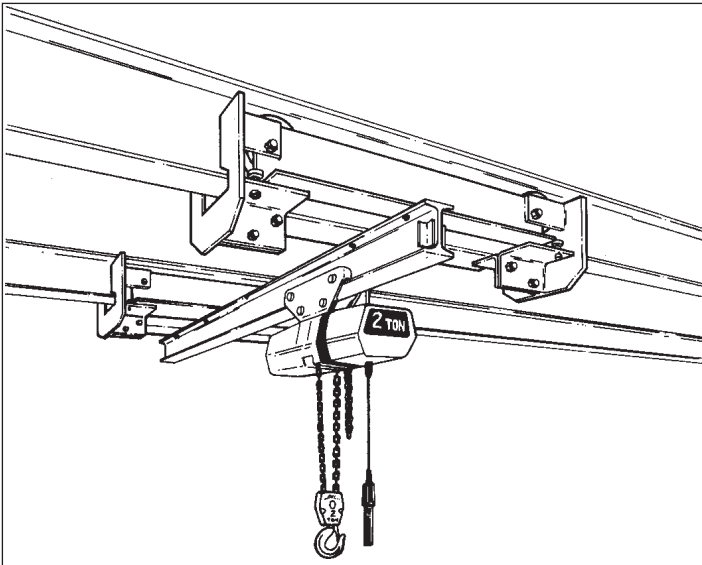

1/4 - 2 Ton
Made in USA

- **CAPACITY** - Up to 2 Tons.
- **ADJUSTABLE** - Fits 6" to 12" American Standard I-Beam runways. Consult factory for patented track or wide-flange beam models.
- **PRECISION WHEELS** - Machined tread iron wheels with sealed ball bearings for low rolling effort.
- **END BUMPERS** - Protect wheels and serve as safety lugs.
- **CONSTRUCTION** - Rugged structural steel for durability with ball bearing guide rollers standard.
- **HARDWARE KIT** - Includes necessary parts to mount span beam. **Note:** Span beam is not included.
- **LIFETIME WARRANTY** - Against defective workmanship or materials is industry's best.

SPECIFICATIONS

Capacity		Model Number	Beam Height (In.)	Flange Width (In.)	Net Wt (Lb.)
(Lb.)	(Ton)				
4000	2	BCD-4000-6	6	3.25 - 3.45	254
4000	2	BCD-4000-8	6 - 8	3.25 - 4.15	265
4000	2	BCD-4000-10	6 - 10	3.25 - 4.81	276
4000	2	BCD-4000-12	6 - 12	3.25 - 5.15	282

NOTE: For complete dimensional data, refer to Coffing Dimensional Databook.

BRIDGING CAPABILITIES

Capacity *		10 Ft. Span Beam Size	12.5 Ft. Span Beam Size	15 Ft. Span Beam Size	17.5 Ft. Span Beam Size	20 Ft. Span Beam Size	22.5 Ft. Span Beam Size	25 Ft. Span Beam Size	27.5 Ft. Span Beam Size	30 Ft. Span Beam Size
(Lb.)	(Ton)									
500	1/4	6" x 12.5#	6" x 12.5#	6" x 12.5#	6" x 12.5#	6" x 12.5#	6" x 12.5#	7" x 15.3#	7" x 15.3#	7" x 20#
1000	1/2	6" x 12.5#	7" x 15.3#	7" x 15.3#	7" x 15.3#	7" x 20#	8" x 18.4#	8" x 23#	10" x 25.4#	10" x 25.4#
2000	1	7" x 15.3#	8" x 18.4#	8" x 23#	10" x 25.4#	10" x 25.4#	10" x 35#	12" x 31.8#	12" x 31.8#	12" x 35#
3000	1 1/2	8" x 23#	10" x 25.4#	10" x 35#	12" x 31.8#	12" x 35#	15" x 42.9#	15" x 42.9#	15" x 42.9#	15" x 42.9#
4000	2	10" x 25.4#	10" x 35#	12" x 31.8#	15" x 42.9#	15" x 42.9#	15" x 42.9#	15" x 42.9#	—	—

* Chain hoist and trolley included in load rating. Loads are based on ASTM-A7 steel beams or equal.

Note: Beams weights are per foot of beam. Multiply weight figure shown by length (in feet) of span beam used, in computing total installed weight.

Caution: Be sure runway beams are parallel, level, and structurally capable of supporting loads you intend to carry – including the weight of the span beam, bridge unit, hoist, trolley, and other accessories. Use a minimum safety factor of 5 : 1. If in doubt, consult a qualified Structural Engineer.

Stamped Steel — Ideal for Construction

LHH Hand Chain Hoist

COFFING LHH Models - Stamped steel hand chain hoists are an excellent low cost option in the Coffing line. The compact, lightweight design is ideal for construction and contractor applications where portability and easy rigging are critical.

- **CAPACITIES & LIFT** - Rated loads from 1/2 to 20 Tons in stock with standard lifts of 10, 15, and 20 feet. Standard hand chain drop is 2-feet less than lift. Other lifts and hand chain drops, and 25 - 50 Ton models available — consult factory.
- **COMPACT AND LIGHTWEIGHT** - Designed for portability and easy installation. Compact gear housing provides low headroom.
- **EASY TO OPERATE** - Lubricated bearings and bushings, bearing-mounted pinions, and heat-treated spur gearing ensure smooth and efficient operation with minimal effort.
- **SAFETY & LOAD CONTROL** - Mechanical load brake engages instantly for precise load holding and positioning. 360° swivel hooks with safety latches for positive load engagement.
- **DURABLE** - Through hardened load chain provides added strength and wear resistance for greater chain life. Stamped steel housing withstands rugged conditions.
- **EASY TO MAINTAIN** - Designed for easy inspection and maintenance. Hoist can be dismantled easily with simple hand tools.
- **LIFETIME WARRANTY**



1/2 - 50 Ton

S P E C I F I C A T I O N S

LHH Hand Chain Hoists

Capacity		Model Number	Lifts (Ft.) **	Strands of Load Chain	Minimum Headroom (In.)	Average Overhaul for 1 Ft. Lift (Ft.)	Net Pull to Lift Rated Load (Lbs.)	Weight for 10 Ft. Lift (Lbs.)
Lbs.	Tons							
1000	1/2	LHH-1/2	10/15/20	1	10 ¹ / ₄	32	55	19
2000	1	LHH-1	10/15/20	1	11 ¹³ / ₁₆	56	53	25
3000	1 1/2	LHH-1 1/2	10/15/20	1	13 ⁹ / ₁₆	75	65	36
4000	2	LHH-2	10/15/20	1	15	75	74	45
6000	3	LHH-3	10/15/20	1	17 ¹ / ₈	95	84	66
10000	5	LHH-5	10/15/20	3	22 ⁵ / ₈	203	79	75
16000	8	LHH-8	10/20	3	32 ¹ / ₂	312.5	77	158
20000	10	LHH-10	10/20	3	32 ¹ / ₂	312.5	95	158
24000	12	LHH-12	10/20	5	50 ⁵ / ₈	526	84	328
30000	15	LHH-15	10/20	5	50 ⁵ / ₈	526	103	328
40000	20	LHH-20	10	6	52 ³ / ₈	312.5 x 2 †	99 x 2 †	535
50000	25*	LHH-25	10	8	52 ⁷ / ₈	416.7 x 2 †	97 x 2 †	680
60000	30*	LHH-30	10	10	65	526.3 x 2 †	104 x 2 †	945
80000	40*	LHH-40	10	14	73 ⁵ / ₁₆	714.3 x 2 †	101 x 2 †	1400
100000	50*	LHH-50	10	20	77 ⁵ / ₈	1000 x 2 †	104 x 2 †	1840

* 25, 30, 40, and 50 Ton models available by special order — consult factory.

** Standard lifts shown. Other lifts available — consult factory.

† LHH-20 through LHH-50 models have two hand chains.

NOTE: For complete dimensional data, refer to Coffing Dimensional Databook.

Proven Industrial Performance

CA and CB Hand Chain Hoists

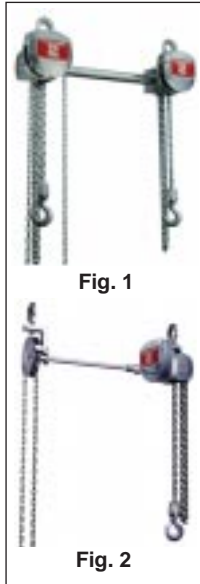
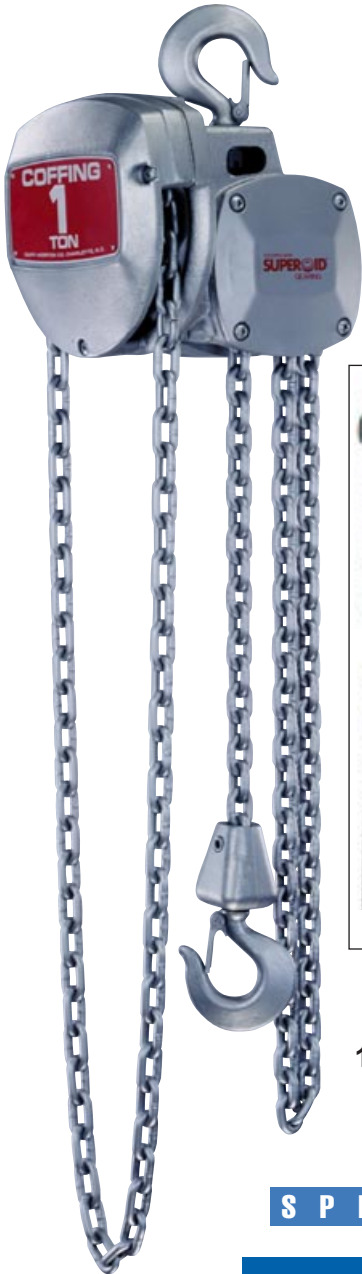

1/2 Ton - CA
1-12 Ton - CB
Made in USA

COFFING CA & CB Models - Hand chain hoists set the standard for performance and durability. The CB has exclusive right angle Superoid® gearing (see facing page) which provides smooth chain travel and requires little maintenance. The CB is ideal for industrial lifting applications.

- **CAPACITIES & LIFT** - Rated loads from 1/2 to 12 Tons. Standard 8-foot lift and 6-foot hand chain drop. Other lifts and hand chain drops available.
- **GOVERNMENT APPROVED** - All CB models except CA-1/2 meet MIL-H-904 Class 2 requirements, Type C, Style 1 or 2.
- **DURABLE** - Impact-resistant, permanent mold aluminum alloy housing provides extra strength and long service life.
- **EASY INSPECTION AND MAINTENANCE** - Easily dismantled with simple hand tools for routine inspection and maintenance.
- **OPTIONAL CAPACITY LIMITER** - Provided when specified at time of order at *no extra charge* (see facing page).
- **LOAD CONTROL** - Fully enclosed, self-adjusting, friction-type screw and disc load brake ensures positive load control.
- **TWIN HOOK (TH Models)** - Available for 1/2 to 3 Ton models. Useful for lifting long, bulky loads. Standard 3-foot space between hooks - for other spacing, consult factory. See Fig. 1
- **EXTENDED HAND WHEEL (EHW Models)** - Available for 1 1/2 to 3 Ton models. Useful for dipping applications or other situations where hoist must be operated from a distance. Standard 3-foot extension - for other lengths, consult factory. See Fig. 2
- **OPTIONS** - Bullard hooks, plated hooks, plated chain, stainless steel chain, spark-resistant features, and top clevis connection available - consult factory. Chain containers available, see page 35.
- **LIFETIME WARRANTY**

SPECIFICATIONS

CA and CB Hand Chain Hoists

Capacity		Model †	Capacity Limiter Model †	Strands of Load Chain	Minimum Headroom (In.)	Hand Chain Overhaul for 1 Ft. Lift (Ft.)	Average Pull to Lift Rated Load (Lbs.)	Net Weight (Lbs.)
Lbs.	Tons							
1000	1/2	CA-1/2*	CA-1/2-CL*	1	13 1/4	18	58	22
2000	1	CB-1	CB-1-CL	1	13 3/8	38	58	38
3000	1 1/2	CB-1 1/2	CB-1 1/2-CL	1	18 1/2	58	62	58
4000	2	CB-2	CB-2-CL	1	18 1/2	58	83	58
6000	3	CB-3	CB-3-CL	1	21 1/2	85	91	78
8000	4	CB-4	CB-4-CL	2	25 1/4	116	85	98
10000	5	CB-5	CB-5-CL	3	26 3/4	174	72	127
12000	6	CB-6	CB-6-CL	3	26 3/4	174	87	127
16000	8	CB-8	CB-8-CL	4	28 1/2	232	90	160
20000	10	CB-10	CB-10-CL	4	31	340	83	212
24000	12	CB-12	CB-12-CL	4	31	340	100	212

NOTE:

For complete dimensional data, refer to Coffing Dimensional Databook.

* Spur gear model.

† Specify TH for twin hook model or EHW for extended hand wheel model (ex. TH-1 or EHW-3).

CA, CB, CTH, TH, EHW & AT Features



Superoid® Gearing

Coffing's exclusive Superoid® gear transmission provides greater strength and durability with fewer wearing parts. This unique right angle gear drive involves only two rugged gears and engages four teeth at all times, providing smooth lifting power and spreading wear to decrease the need for maintenance.

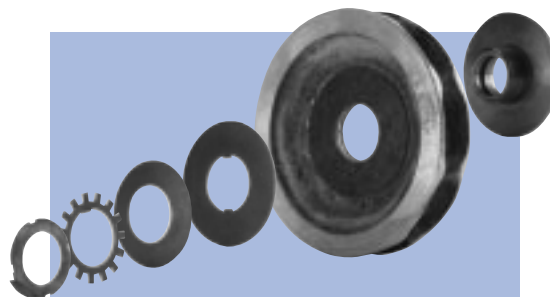

Capacity Limiter

Coffing's optional capacity limiter protects the operator, the load, and the hoist. Under severe overload conditions, the capacity limiter's clutch assembly automatically disengages the handwheel to prevent lifting of a dangerous overload. Removing the overload automatically restores the lifting capacity of the hoist. The capacity limiter is provided when specified at *no extra charge*.

CTH — Trolley Mounted Suspension

COFFING CTH Models - Featuring a CA or CB hoist integrally mounted to a CT trolley. The CTH is ideal for industrial lifting applications which require a trolley mounted hoist for horizontal movement of the load.

- **CAPACITIES & LIFT** - Rated loads from 1/2 to 6 Tons in plain or geared trolley models. Standard 8-foot lift and 6-foot hand chain drop, with other lifts and hand chain drops available.
- **REDUCED HEADROOM** - Lug-mounted trolley hoist design.
- **HOIST FEATURES** - Please refer to CA and CB information on previous page.
- **OPTIONS** - Capacity limiter available - provided when specified at time of order at *no extra charge*. Special trolley wheels, spark resistant features, and track clamps available — consult factory.



SPECIFICATIONS

CTH Trolley Mounted Hoists

Capacity		Model Number	Minimum Headroom (In.)	Hand Chain Overhaul for 1 Ft. Lift (Ft.)	Average Pull to Lift Rated Load (Lbs.)	Std. Beam Height (In.)	Minimum Radius Curve (In.)	Net Weight	
Lbs.	Tons							Plain (P) (Lbs.)	Geared (G) (Lbs.)
1000	1/2	CTH-1/2-P(G)*	14	18	58	6-18	48	64	71
2000	1	CTH-1-P(G)	14 ³ / ₈	38	58	6-18	48	80	87
3000	1 1/2	CTH-1 1/2-P(G)	18 ³ / ₄	58	62	6-18	48	100	107
4000	2	CTH-2-P(G)	18 ³ / ₄	58	83	6-18	48	100	107
6000	3	CTH-3-P(G)	20	85	91	6-18	48	135	142
8000	4	CTH-4-P(G)	27 ¹ / ₁₆	116	85	8-18	**	221	228
10000	5	CTH-5-P(G)	27 ³ / ₄	174	72	8-18	**	280	287
12000	6	CTH-6-P(G)	27 ³ / ₄	174	87	8-18	**	280	287

NOTE:
For complete dimensional data, refer to Coffing Dimensional Databook.

NOTE: When ordering, specify "P" for plain trolley or "G" for geared trolley.

* Spur gear model.

** For Straight track only. Articulated model for 48 inch minimum radius curve track available. For wide flange and patented track applications, consult factory.

1/2 - 6 Ton

Made in USA

Low Headroom — Government Approved

AT Model Hand Chain Hoist



1/2 - 8 Ton
Made in USA

COFFING AT Model - An Army-type trolley hoist. The AT is ideal for industrial lifting applications which require low headroom for longer hook travel.

- **CAPACITIES & LIFT** - Rated loads from 1/2 to 8 Tons in plain or geared trolley models. Standard 8-foot lift with 6-foot hand chain drop. Other lifts and hand chain drops available.
- **GOVERNMENT APPROVED** - All models meet MIL-H-904 Class 1 and Class 2 requirements, Type D or E, Style 1 or 2.
- **LOW HEADROOM** - Army-type trolley hoist design provides excellent headroom for longer hook travel.
- **RUGGED** - Hoist housing and frame made from iron material.
- **DUAL ARTICULATING TROLLEYS** - Designed to travel tight radius curved beams.
- **OPTIONAL CAPACITY LIMITER** - Clutch assembly prevents lifting of damaging overloads by disengaging the hand wheel, protecting both the operator and the load. Provided when specified - at *no extra charge*.
- **LONG-LIFE** - Unique right angle drive provides superior performance with fewer wearing parts. Exclusive Superoid® gearing engages more gear teeth to support the load (see page 31).
- **LOAD CONTROL** - Fully enclosed, self-adjusting, friction-type screw and dual disc Weston load brake ensures positive load control.
- **OPTIONS** - Bullard hooks, plated hooks, plated chain, stainless steel chain, spark-resistant features, and top clevis connection available — consult factory. Chain containers available, see page 35.
- **LIFETIME WARRANTY**

SPECIFICATIONS

AT Hand Chain Hoists

Capacity		Model Number	Strands of Load Chain	Minimum Headroom (In.)	Hand Chain Overhaul for 1 Ft. Lift (Ft.)	Average Pull to Lift Rated Load (Lbs.)	Std. Beam Height (In.)	Min. Radius Curve (In.)	Net Weight	
Lbs.	Tons								Plain (P) (Lbs.)	Geared (G) (Lbs.)
1000	1/2	AT-1/2-P(G)	1	10 ^{3/16}	24	39	6-18	21	94	101
2000	1	AT-1-P(G)	2	11	48	41	6-18	21	98	105
3000	1 1/2	AT-1 1/2-P(G)	1	14 ^{5/8}	58	62	6-18	21	152	159
4000	2	AT-2-P(G)	1	14 ^{5/8}	58	83	6-18	21	152	159
6000	3	AT-3-P(G)	2	19 ^{1/8}	116	64	6-18	21	167	174
8000	4	AT-4-P(G)	2	19 ^{1/8}	116	85	6-18	21	167	174
10000	5	AT-5-P(G)	3	21 ^{5/16}	174	72	6-18	48	195	202
12000	6	AT-6-P(G)	3	21 ^{5/16}	174	87	6-18	48	195	202
16000	8	AT-8-P(G)	4	20 ^{3/4}	232	90	6-18	48	241	248

NOTE: When ordering, specify "P" for plain trolley or "G" for geared trolley.

NOTE: For complete dimensional data, refer to Coffing Dimensional Databook.

Close Headroom — Government Approved

YLH Model Hand Chain Hoist

COFFING YLH Model - An Army-type trolley hoist with a one-piece suspension frame which straddles the beam to provide minimum headroom and maximum hook travel. The YLH is recommended for industrial applications which require maximum floor-to-beam lifting capabilities.

- **CAPACITIES AND LIFTS** - Rated loads from 1/2 to 12 Tons. Standard 8-foot lift with 6-foot hand chain drop. Other lifts available.
- **GOVERNMENT APPROVED** - All models meet MIL-H-904 Class 2 requirements, Type F or G, Style 1 or 2.
- **MINIMUM HEADROOM** - Provided by aluminum alloy one-piece suspension frame which allows maximum hook travel.
- **DUAL ARTICULATING TROLLEYS** - Easily travels curved beams.
- **OPTIONAL CAPACITY LIMITER** - Prevents lifting damaging overloads, protecting both the load and operator. Provided when specified - *at no extra charge.*
- **LOAD CONTROL** - Load brake has a 6-tooth holding pawl that engages a 24-tooth holding ratchet at 6 points simultaneously to eliminate side pressure on load bearing surfaces.
- **LONG CHAIN LIFE** - Forged alloy steel load sheave with precision machined chain pockets gives accurate chain fit for extended chain life. Aluminum die-cast hand chain guide and cover prevent damaging jamming of hand chain.
- **OPTIONS** - Bullard hooks, plated hooks, plated chain, stainless steel chain, spark-resistant features, and top clevis connection available — consult factory. Chain containers available — consult factory.
- **LIFETIME WARRANTY**



1/2 - 12 Ton
Made in USA

SPECIFICATIONS

YLH Hand Chain Hoists

Capacity		Model	Strands of Load Chain	Minimum Headroom (In.)	Hand Chain Overhaul for 1 Ft. Lift (Ft.)	Average Pull to Lift Rated Load (Lbs.)	I-Beam Width (In.)	Std. Beam Height (In.)	Min. Radius Curve (In.)	Net Weight	
Lbs.	Tons									Plain "P" (Lbs.)	Geared "G" (Lbs.)
1000	1/2	YLH-1/2P(G)*	4	6	44	27	2.66-5.50	4-12	21	180	195
2000	1	YLH-1P(G)*	4	6	44	53	3.00-5.50	5-12	30	200	215
3000	1 1/2	YLH-1 1/2P(G)*	4	6 1/2	44	78	3.00-5.50	5-12	30	210	225
4000	2	YLH-2P(G)*	4	7	66	71	3.33-6.25	6-18	36	220	236
6000	3	YLH-3P(G)*	4	7 1/4	66	105	3.33-6.25	6-18	36	225	238
8000	4	YLH-4P(G)*	4	9 1/4	128 1/2	71	4.00-8.048	8-24	48	545	575
10000	5	YLH-5P(G)*	4	10 3/8	128 1/2	89	4.00-8.048	8-24	48	543	569
12000	6	YLH-6P(G)*	4	10 3/8	128 1/2	106	4.00-8.048	8-24	48	560	590
16000	8	YLH-8P(G)*	6	10 7/8	192	104	4.66-8.048	10-24	72	705	735
20000	10	YLH-10P(G)	8	14	257	104	4.66-8.048	10-24	72	764	805
24000	12	YLH-12P(G)	8	14	257	108	4.66-8.048	10-24	72	764	805

NOTE: When ordering, please specify "P" for plain trolley or "G" for geared trolley.

* Spark resistant features available. **NOTE:** For complete dimensional data, refer to Coffing Dimensional Databook.

TROLLEYS & BEAM CLAMPS

ET-A Trolley

COFFING ET-A Model - The economical choice for most commercial and light-duty industrial applications. The ET-A can be modified to fit a variety of beam styles and sizes, up to an 8" flange width.

- **CAPACITIES** - Rated loads from 1/4 to 5 Tons.
- **ECONOMICAL** - Excellent low cost choice for most manual and light-duty powered applications
- **UNIVERSAL HANGING CLEVIS** - Accepts all Coffing hook-mounted hoists.
- **ADJUSTABLE** - Trolley is easily adjusted to fit any tapered or flat beam flange within range of adjustment, up to an 8" flange width.
- **WRAP-AROUND SIDE PLATES** - Act as safety lugs to increase operator safety and act as bumpers to protect wheels.
- **DUAL TREAD WHEELS** - Cast iron wheels fit any tapered or flat beam flange within range of adjustment. Wheels include permanently lubricated, shielded ball bearings for long life and low maintenance.
- **OPTIONS** - Adapter lugs available for mounting EC and ELC hoists.
- **LIFETIME WARRANTY**



1/4 - 5 Ton
Made in USA

S P E C I F I C A T I O N S

ET-A Trolleys

Capacity		Model Number	Standard Beam Height (In.)	I-Beam Width (In.)	Minimum Radius Curve (In.) †	Wheel Tread Diameter (In.)	Net Weight (Lbs.)
Lbs.	Tons						
500	1/4	ET-05-A	4-10	2.66-8.045	36	2 1/4	14
1000	1/2	ET-10-A	4-10	2.66-8.045	36	2 1/4	14
2000	1	ET-20-A	5-12	3.00-8.045	48	2 3/4	23
3000	1 1/2	ET-30-A	6-18	3.33-8.045	60	4 1/4	52
4000	2	ET-40-A	6-18	3.33-8.045	60	4 1/4	52
6000	3	ET-60-A	8-20	4.00-8.045	60	4 1/4	60
10000	5	ET-100-A	10-24	4.60-8.05	60	4 3/8	96

NOTE:
For complete dimensional data, refer to Coffing Dimensional Databook.

† Minimum recommended radius for best wheel life.

BC Beam Clamps

COFFING BC Models - Ideal as an anchor for rigging operations (vertical or horizontal), as a hoisting anchor, or as a tool for positioning and holding beams for welding. The BC is recommended for commercial, construction, and industrial applications.

- **CAPACITIES** - Rated loads from 1 -10 Ton.
- **REDUCED FLANGE STRESS** - Special clamp jaw design distributes load away from flange edge.
- **ADJUSTABLE** - Threaded mechanism fits securely on a wide range of flange widths and beam sizes.
- **LOW HEADROOM** - Provided by built-in suspension bar.
- **LIFETIME WARRANTY**

Capacity		Model Number	Flange Width (In.)	Weight (Lbs.)
Lbs.	Tons			
2000	1	BC-1	3 - 9	9
4000	2	BC-2	3 - 9	13
6000	3	BC-3	3.2 - 12.6	18
10000	5	BC-5	3.6 - 12.2	22
20000	10	BC-10	3.6 - 12.6	32



1 - 10 Ton

CT Trolley

COFFING CT Model - Available in plain and geared models which can be modified to fit a wide range of beam sizes and styles. The CT is designed to provide easy operation and superior performance in industrial lifting applications.

- **CAPACITIES** - Rated loads from 1/4 to 5 Tons in plain and geared models. Geared trolleys have standard 6-foot hand chain drop. Other hand chain drops available.
- **RUGGED** - Designed to provide superior performance and long, efficient service.
- **EASY OPERATION** - Lowest rolling effort of Coffing trolley lines.
- **UNIVERSAL MOUNTING** - Clevis accepts all Coffing hook-mounted hoists, or lug-mounted hoists attach directly to load pins.
- **ADJUSTABLE** - Trolley easily adjusts to fit any beam flange within range of adjustment.
- **WRAP-AROUND SIDE PLATES** - Act as safety lugs to increase operator safety and act as bumpers to protect wheels.
- **CAST IRON WHEELS** - Fully machined wheels fit any tapered beam flange within range of adjustment. Wheels include permanently lubricated, shielded ball bearings for long life and low maintenance. Wide flange and patented track wheels available.
- **OPTIONS** - Spark resistant and corrosion resistant wheels available. Track clamps available on 1/4 to 4 Ton models.
- **LIFETIME WARRANTY**



1/4 - 5 Ton
Made in USA

SPECIFICATIONS

CT Trolleys — Plain & Geared

Capacity		Model Number *	Standard Beam Height (In.)	I-Beam Width (In.)	Minimum Radius Curve (In.)	Net Weight	
Lbs.	Tons					Plain (P) (Lbs.)	Geared (G) (Lbs.)
500	1/4	CT-05P(G)	6-18	3.33-6.00	48	42	49
1000	1/2	CT-10P(G)	6-18	3.33-6.00	48	42	49
2000	1	CT-20P(G)	6-18	3.33-6.00	48	42	49
4000	2	CT-40P(G)	6-18	3.33-6.00	48	42	49
6000	3	CT-60P(G)	6-18	3.33-6.00	48	57	64
8000	4	CT-80P(G)†	8-18	4.00-6.00	**	123	130
10000	5	CT-100P(G)†	8-18	4.00-6.00	**	153	160

* When ordering, specify "P" for plain trolley or "G" for geared trolley.

** Standard model for straight track only. Articulating model for 4-foot minimum radius curve available - consult factory.

† Eight-wheel trolley design - reduces beam flange stress. **NOTE:** For complete dimensional data, refer to Coffing Dimensional Databook.

Chain Containers

For CA, CB, CTH, TH, EHW, and AT Models*

Hoist Capacity	Lift	Part Number	Hoist Capacity	Lift	Part Number
1/2 Ton	0' - 26'	JF926-1	1 1/2 - 2 Ton	0' - 12'	JF926-2
	27' - 31'	JF926-2		13' - 22'	JF926-3
	32' - 42'	JF926-3		23' - 35'	JF926-4
	43' - 54'	JF926-4			
1 Ton	0' - 20'	JF926-1	3 Ton	0' - 12'	JF926-2
	21' - 25'	JF926-2		13' - 17'	JF926-3
	26' - 35'	JF926-3		18' - 25'	JF926-4
	36' - 50'	JF926-4	4 Ton	0' - 6'	JF926-2
		7' - 11'		JF926-3	
				12' - 17'	JF926-4

* Other lifts and capacities available — consult factory.



CY Trolley

COFFING CY Model - Designed to meet all your heavy lifting needs. The CY can be adapted for a variety of beam sizes and styles, and can be equipped with spark resistant features. The CY is recommended for heavy-duty industrial applications.

- **CAPACITIES** - Rated loads from 4-40 Tons in plain and geared models. Geared trolleys have standard 7-foot hand chain drop.
- **RUGGED** - Designed for heavy-duty industrial applications.
- **HANGING CLEVIS** - Accepts all Coffing hook-mounted hoists. Steel equalizing pin can be used to suspend hoist for low headroom applications.
- **ADJUSTABLE** - Fits a wide range of beam sizes.
- **SIDE PLATES WITH SAFETY LUGS** - Act as safety lugs to increase operator safety and act as bumpers to protect wheels.
- **BALL TREAD WHEELS** - Fully machined forged steel wheels (4-6 Ton models) or cast iron wheels (8-20 Ton models) fit any tapered or flat beam flange within range of adjustment. Each wheel has two lifetime lubricated, sealed tapered roller bearings for long life and low maintenance.
- **OPTIONS** - Wide flange and patented track models available. Spark resistant units available in 4 to 8 Ton models.
- **LIFETIME WARRANTY**



4 - 40 Ton
Made in USA

SPECIFICATIONS

CY Trolleys — Plain & Geared

Capacity		Model Number *	Beam Height (In.)	I-Beam Width (In.)	Minimum Radius Curve (In.)	Net Weight	
Lbs.	Tons					Plain (Lbs.)	Geared (Lbs.)
8000	4	CY-80P(G)	8-24	4.00-7.00	60	138	175
10000	5	CY-100P(G)	8-24	4.00-7.00	60	140	180
12000	6	CY-120P(G)	8-24	4.00-7.00	60	140	180
16000	8	CY-160P(G)	10-24	4.66-7.00	72	255	295
20000	10	CY-200P(G)	10-24	4.66-7.00	72	274	310
24000	12	CY-240P(G)	10-24	4.66-7.00	72	278	320
32000	16	CY-320P(G)	18-24	6.00-8.00	96	800	840
40000	20	CY-400P(G)	18-24	6.00-8.00	96	810	850
50000	25	CY-500P(G)	24	7.00-8.00	**	760	800
60000	30	CY-600P(G)	24	7.00-8.00	**	2,030	2,070
80000	40	CY-800P(G)	24	7.00-8.00	**	2,060	2,100

NOTE:

For complete dimensional data, refer to Coffing Dimensional Databook.

* When ordering, specify "P" for plain trolley or "G" for geared trolley.

** Consult factory.



FEATURES

Ratchet Lever Hoists

Coffing engineers have developed a full line of ratchet lever hoists to meet all your rigging needs. Our models have a variety of features that make each one uniquely suited for your applications. Choose from a variety of housing materials, brake options, load limiter options, and lifts, as well as special features such as plated chain and hooks. We feel confident that you will find the ratchet lever hoist you need!



LSB-A Model

Free Chain Mechanism

The LSB-A models feature a one-handed free chaining mechanism which allows quick and easy take-up of slack chain. There is an unconditional lifetime warranty on the free chain knob.

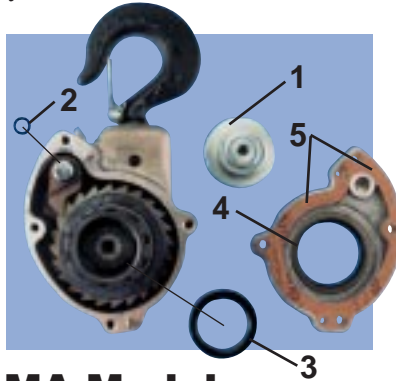

MA Model

Five Seals

Efficient hoist performance is assured by keeping moisture, oils, chemicals, and dirt out of the brake mechanism. Neoprene seals on the (1) Handle cap, (2) Load pawl shaft, (3) Load sheave, (4) Cover plate, and (5) Gasket on the cover plate, provide protection under exposure conditions.



MAL Model

Overload Slip Clutch

The MAL slip clutch load limiting device protects the load, the operator, and the hoist by preventing the lifting of damaging overloads. The gradual slip mechanism prevents sudden, unexpected movement of the handle.



RA Model

Ratchet and Pawl Design

When using an RA model, one pawl is always engaged with the ratchet during lifting and lowering operations. Ratchet and pawl design is useful for applications where a mechanical load brake is not desirable.

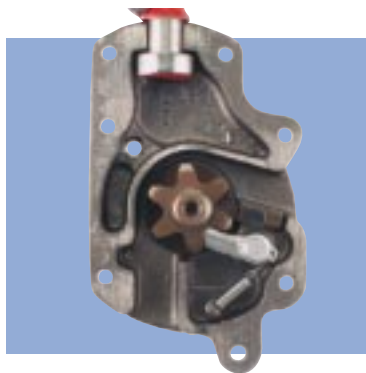

G Series Model

Single-Locking Pawl

The G Series single-pawl hoist is ideal for all types of work where a full stroke of the handle is permitted. The single-pawl design provides faster operation and longer incremental lift than the double-pawl design.



G Series Model

Double-Locking Pawl

The G Series double-locking pawl hoist is preferable when working in close quarters where a full stroke of the handle is not permitted. The load can be raised or lowered with a half-stroke of the handle. Can be furnished on all models up to and including 3-ton capacity.

Stamped Steel — Versatile Performer

LSB-A Ratchet Lever Hoist

COFFING LSB-A Model - Stamped steel ratchet lever hoists are lightweight and durable. The LSB-A's low handle effort and 360° rotating handle make it easy to operate, and the one-handed free chaining mechanism provides easy rigging. The LSB-A is ideal for construction and commercial applications.

- **CAPACITIES & LIFT** - Rated loads of 3/4, 1 1/2, 3, and 6 Tons, with 5, 10, 15, and 20 foot standard lifts. Other lifts available.
- **RUGGED AND LIGHTWEIGHT** - Impact resistant stamped steel housing withstands rigorous use. Compact design is portable and easy to rig.
- **LOW HANDLE EFFORT** - Double reduction gearing and short handle with cushioned grip provide easy operation with minimal handle effort.
- **360° ROTATING HANDLE** - Provides versatile rigging options when used in confined spaces.
- **EASY FREE CHAINING** - State-of-the-art free wheeling mechanism allows quick and easy one-handed take-up and positioning of slack chain. Unconditional lifetime warranty on free-chain knob. See page 37.
- **POSITIVE LOAD CONTROL** - Enclosed screw-and-disc type load brake stays clean and dry for positive load positioning. Safety latches on hooks for positive load engagement.
- **LONGER CHAIN LIFE** - Through-hardened load chain provides high strength and resists wear.
- **LIFETIME WARRANTY**



3/4 - 6 Ton

SPECIFICATIONS

LSB-A Ratchet Lever Hoists

Capacity		Model Number	Lift (Ft.) *	Strands of Load Chain	Minimum Distance Between Hooks (In.)	Handle Length (In.)	Average Handle Effort (Lbs.)	Net Weight (Lbs.)
Lbs.	Tons							
1500	3/4	LSB-1500A-5	5	1	11 ⁵ / ₈	9 ¹ / ₄	46	13
1500	3/4	LSB-1500A-10	10	1	11 ⁵ / ₈	9 ¹ / ₄	46	15
1500	3/4	LSB-1500A-15	15	1	11 ⁵ / ₈	9 ¹ / ₄	46	17
1500	3/4	LSB-1500A-20	20	1	11 ⁵ / ₈	9 ¹ / ₄	46	19
3000	1 1/2	LSB-3000A-5	5	1	14 ³¹ / ₃₂	13 ³ / ₄	55	22
3000	1 1/2	LSB-3000A-10	10	1	14 ³¹ / ₃₂	13 ³ / ₄	55	25
3000	1 1/2	LSB-3000A-15	15	1	14 ³¹ / ₃₂	13 ³ / ₄	55	28
3000	1 1/2	LSB-3000A-20	20	1	14 ³¹ / ₃₂	13 ³ / ₄	55	31
6000	3	LSB-6000A-5	5	1	16 ⁹ / ₁₆	13 ³ / ₄	77	34
6000	3	LSB-6000A-10	10	1	16 ⁹ / ₁₆	13 ³ / ₄	77	39
6000	3	LSB-6000A-15	15	1	16 ⁹ / ₁₆	13 ³ / ₄	77	44
6000	3	LSB-6000A-20	20	1	16 ⁹ / ₁₆	13 ³ / ₄	77	49
12000	6	LSB-12000A-5	5	2	22 ⁷ / ₁₆	13 ³ / ₄	84	64
12000	6	LSB-12000A-10	10	2	22 ⁷ / ₁₆	13 ³ / ₄	84	75
12000	6	LSB-12000A-15	15	2	22 ⁷ / ₁₆	13 ³ / ₄	84	86
12000	6	LSB-12000A-20	20	2	22 ⁷ / ₁₆	13 ³ / ₄	84	97

NOTE:
For complete dimensional data, refer to Coffing Dimensional Databook.

* Standard lifts shown. Other lifts available - consult factory.

Aluminum Construction — Low Handle Effort

PA Model Ratchet Lever Hoist

COFFING PA Model - Aluminum ratchet lever hoists provide high quality and durability. The PA's extremely low handle effort and 360° rotating handle make it easy to operate, and the one-handed free chaining mechanism provides easy rigging. The PA is ideal for construction and commercial applications.

- **CAPACITIES & LIFT** - Rated loads of ¾, 1, 1½, and 3 Tons, with 5, 10, 15, and 20 foot standard lifts.
- **RUGGED AND LIGHTWEIGHT** - Unit and handle made from high strength ductile aluminum alloy. Compact design increases portability and rigging efficiency.
- **EASY TO USE** - Double reduction gearing and short handle provide lowest handle effort in the Coffing line.
- **360° ROTATING HANDLE** - Provides versatile rigging options when used in confined spaces.
- **EASY FREE CHAINING** - State-of-the-art free wheeling mechanism allows quick and easy one-handed take-up and positioning of slack chain.
- **POSITIVE LOAD CONTROL** - Enclosed self-adjusting screw-and-disc type load brake stays clean and dry — eliminating drift and backlash for safe, sure holding. Screw-and-disc brake lowering allows “micro-inching” load positioning.
- **LOW MAINTENANCE** - Hardened steel load chain provides high strength and resists wear. Alloy steel spur gearing is heat-treated for long life and is lifetime lubricated.
- **LIFETIME WARRANTY**



¾ - 3 Ton

S P E C I F I C A T I O N S

Capacity		Model Number	Lift (Ft.)*	Strands of Load Chain	Minimum Distance Between Hooks (In.)	Handle Length (In.)	Average Handle Effort (Lbs.)	Net Weight (Lbs.)
Lbs.	Tons							
1500	¾	PA-1500	5	1	12	12	37	15
1500	¾	PA-1510	10	1	12	12	37	17
1500	¾	PA-1515	15	1	12	12	37	19
1500	¾	PA-1520	20	1	12	12	37	21
2000	1	PA-2000	5	1	13	12	49	15
2000	1	PA-2010	10	1	13	12	49	17
2000	1	PA-2015	15	1	13	12	49	19
2000	1	PA-2020	20	1	13	12	49	21
3000	1½	PA-3000	5	1	14½	12	41	25
3000	1½	PA-3010	10	1	14½	12	41	29
3000	1½	PA-3015	15	1	14½	12	41	33
3000	1½	PA-3020	20	1	14½	12	41	37
6000	3	PA-6000	5	2	17½	16	61	41
6000	3	PA-6010	10	2	17½	16	61	48
6000	3	PA-6015	15	2	17½	16	61	55
6000	3	PA-6020	20	2	17½	16	61	62

NOTE:
For complete dimensional data, refer to Coffing Dimensional Databook.

Five Seals Protect Internal Components



3/4 - 6 Ton
Made in USA

MA and MAL Ratchet Lever Hoists

COFFING MA and MAL Models - Survive the toughest environments to provide safe, secure load control. Five seals (exclusive to the MA and MAL) increase the life of the hoist by protecting the gears and the brake mechanism from contamination by oil, grease, dirt, water, and other environmental hazards (see page 37). The MA and MAL are ideal for construction, industrial, and maintenance applications which require a brake for precise positioning or to disengage the tension on the load.

- **CAPACITIES & LIFT** - Rated loads from 3/4 to 6 Tons, with 5-foot standard lift. Other lifts available.
- **RUGGED** - Unit and handle made from high strength ductile aluminum alloy for corrosion resistance and portability.
- **FREE CHAINING MECHANISM** - Allows quick and easy one-handed take-up and positioning of slack chain. Will not accidentally free chain when under load.
- **FIVE SEALS** - Keep the brake mechanism clean and dry, so braking performance remains consistent even under severe exposure conditions.
- **LOAD LIMITER (MAL Models)** - See page 37.
- **PRECISE LOAD POSITIONING** - Screw and disc brake lowering allows “micro-inching” for load spotting within fractions of an inch.
- **HANDLE STOPS** - Keep handle from spinning in case operator’s hand accidentally slips off the handle.
- **TOP SLING MODELS** - Allow secure fastening around posts, beams, and other anchor points for easy rigging. MAR model has 30” sling with grab hook.
- **OPTIONS** - Bullard hooks, bronze hooks, zinc-plated hooks, and zinc-plated chain - consult factory.
- **LIFETIME WARRANTY**

S P E C I F I C A T I O N S

MA / MAL Ratchet Lever Hoists

Capacity		Model Number *	Strands of Load Chain	Minimum Distance Between Hooks (In.)	Handle Length (In.)	Minimum Lifting Increment (In.) †	Average Handle Effort (Lbs.)	Net Weight (Lbs.) ††
Lbs.	Tons							
1500	3/4	MA(L)-15	1	12 ⁷ / ₈	20 ¹ / ₂	.188	61	14 ¹ / ₄
2000	1	MA(L)-20	1	12 ⁷ / ₈	20 ¹ / ₂	.188	81	14 ¹ / ₄
3000	1 ¹ / ₂	MA(L)-15-2	2	17	20 ¹ / ₂	.094	61	20 ¹ / ₄
3000	1 ¹ / ₂	MA(L)-30	1	15	20 ¹ / ₂	.088	82	23
4000	2	MA(L)-40	1	15	20 ¹ / ₂	.088	109	23
6000	3	MA(L)-30-2	2	18 ³ / ₄	20 ¹ / ₂	.044	87	36
9000	4 ¹ / ₂	MA(L)-30-3	3	23 ¹ / ₈	20 ¹ / ₂	.029	90	53
12000	6	MA(L)-30-4	4	22	20 ¹ / ₂	.022	93	63

* Designate MAL model number for load limiter option. Designate MAR for 30" top sling with grab hook. Longer slings available.

† Minimum increment in lowering position is infinitesimal.

†† Add approximately 2 Lbs. for MAL version.

NOTE: For complete dimensional data, refer to Coffing Dimensional Databook.

Easy Operator — Ratchet & Pawl Design

RA Model Ratchet Lever Hoist

COFFING RA Model - Aluminum ratchet lever hoists utilize a ratchet and pawl design. The RA is ideal for transmission and distribution utility applications where a disc brake mechanism is not desirable.

- **CAPACITIES & LIFT** - Rated loads from 3/4 to 6 Tons, with 5-foot standard lift. Other lifts available.
- **RUGGED** - Unit and handle made from high strength ductile aluminum alloy for corrosion resistance and portability.
- **FREE CHAINING MECHANISM** - Allows quick and easy one-handed take-up and positioning of slack chain. Will not accidentally free chain when under load.
- **RATCHET AND PAWL DESIGN** - Provides easy operation and freedom from maintenance. One pawl is always engaged with the ratchet during lifting and lowering operations, so handle will not ratchet when lowering a load if handle is unintentionally released.
- **OPEN BODY CONSTRUCTION** - Permits easy inspection of suspension hook assembly.
- **HANDLE STOPS** - Keep handle from spinning in case operator's hand accidentally slips off the handle.
- **MULTIPLE RIGGING OPTIONS** - Hoist can lift, pull, or bind. Can be operated from either side and will work in any position with equal efficiency.
- **TOP SLING MODELS** - Allow secure fastening around posts, beams, and other anchor points for easy rigging. RAR model has 30" sling with grab hook. RADO model has a 15" sling with a standard hook.
- **OPTIONS** - Bullard hooks, bronze hooks, zinc-plated hooks, and zinc-plated chain - consult factory.
- **LIFETIME WARRANTY**



3/4 - 6 Ton
Made in USA

SPECIFICATIONS

RA Ratchet Lever Hoist

Capacity		Model Number*	Strands of Load Chain	Minimum Distance Between Hooks (In.)	Handle Length (In.)	Minimum Increment (In.) †	Average Handle Effort (Lbs.)	Net Weight (Lbs.)
Lbs.	Tons							
1500	3/4	RA-15	1	12 ⁷ / ₁₆	20 ¹ / ₂	.451	59	12 ¹ / ₄
2000	1	RA-20	1	12 ⁷ / ₁₆	20 ¹ / ₂	.451	79	12 ¹ / ₄
3000	1 ¹ / ₂	RA-15-2	2	17 ¹ / ₄	20 ¹ / ₂	.226	60	18
3000	1 ¹ / ₂	RA-30	1	13 ³ / ₄	20 ¹ / ₂	.256	82	23
4000	2	RA-40	1	13 ³ / ₄	20 ¹ / ₂	.256	109	23
6000	3	RA-30-2	2	17 ¹ / ₄	20 ¹ / ₂	.128	93	35
9000	4 ¹ / ₂	RA-30-3	3	22	20 ¹ / ₂	.085	96	53
12000	6	RA-30-4	4	22	20 ¹ / ₂	.064	97	63



* Designate RAR model for 30" top sling with grab hook, or RADO model for 15" top sling with standard hook. Longer sling lengths available.

† Minimum increment in lifting or lowering position.

NOTE: For complete dimensional data, refer to Coffing Dimensional Databook.

For Lifting or Pulling Applications

G Series Ratchet Lever Hoists



3/4 - 15 Ton
Made in USA

COFFING G Series Model - Malleable iron roller chain ratchet lever hoists are efficient and durable. Roller chain can be spliced to create longer lifts and can handle higher capacities than coil chain. G Series hoists are ideal for utility transmission and distribution work.

- **CAPACITIES & LIFT** - Rated loads from 3/4 to 15 Tons. For standard lift, see chart below. Other lifts available.
- **RUGGED** - Unit and handle made from malleable iron. Riveted construction makes the unit tamper-resistant.
- **FREE CHAINING** - Free chaining mechanism allows quick and easy take-up and positioning of slack chain. Hoist will not free chain when under load.
- **HANDLE STOPS** - Prevent handle from spinning if it is accidentally released by the operator.
- **SINGLE OR DOUBLE LOCKING PAWL DESIGN** - See page 37.
- **MULTIPLE RIGGING OPTIONS** - Hoist can lift, pull, or bind. Can be operated from either side and will work in any position with equal efficiency.
- **SNAP HOOK AND LINK** - Allows operator to convert unit to next smaller capacity to give longer lift and faster operation. Snap hook acts as an end stop and will not pass through chain sprocket.
- **OPTIONS** - Bullard hooks, bronze hooks, and zinc-plated hooks - consult factory.
- **LIFETIME WARRANTY**

SPECIFICATIONS

G Series Ratchet Lever Hoists

Capacity		Model Number †	Standard Lift (In.)	Strands of Load Chain	Minimum Dist. Between Hooks (In.)	Handle Length (In.)	Minimum Increment (In.) †	Average Handle Effort (lbs.)	Net Weight (Lbs.)
Lbs.	Tons								
1500	3/4	AG/AGI	56 1/2	1	13	18 3/4	.624/.313	56	14
3000	1 1/2	ATG/ATGI	57	2	15	18 3/4	.313/.156	60	17
3000	1 1/2	FG/FGI	56 1/2	1	16	27 5/8	1.000/.500	116	25
6000	3	FTG/FTGI	57	2	17 5/8	27 5/8	.500/.250	120	34
9000	4 1/2	ZG-4 1/2	53	3	25	33 5/8	.333	124	49
12000	6	ZG-6	53	4	25	33 5/8	.250	124	59
18000	9	WG-9	60	5	30	33 5/8	.200	124	120
22000	11	WG-11	60	6	30	33 5/8	.167	124	130
26000	13	WG-13	60	7	30	33 5/8	.143	124	140
30000	15	WG-15	60	8	30	33 5/8	.125	124	150

† First designation is single pawl model and second "I" designation is double pawl model.

NOTE: For complete dimensional data, refer to Coffing Dimensional Databook.

Safety, Durability Plus Versatility

Cable Ratchet Lever Hoist

COFFING Cable Models - Provide high quality and durability, with a wide variety of rigging options. The Cable Hoists are designed for safety and have many features that provide easy operation. The Cable Hoists are ideal for construction and commercial applications.

- **CAPACITIES & LIFT** - Rated loads from 1/4 to 2 Tons, with standard lifts ranging from 6 to 29 feet in single-line and double-line configurations.
- **ALL MODELS MEET ANSI STANDARD B-30.21** - For overhead lifting.
- **RUGGED AND LIGHTWEIGHT** - Housings made from high strength aluminum alloy. Unit weights range from 7 to 15 Lbs.
- **HANDLE DESIGNED FOR OVERLOAD PROTECTION** - Handle bends to warn of hazardous condition and prevents dangerous overload.
- **HEAVY DUTY CABLE** - Unit utilizes preformed and galvanized 7 X 19 (133 strand) extra flexible aircraft cable.
- **FAST CABLE TAKE-UP** - Winding wheel provides quick take-up or positioning of cable.
- **POSITIVE LOAD CONTROL** - Double interlocking pawl system holds load in all environments.
- **LOW MAINTENANCE** - Stainless steel shafts and springs resist corrosion. All rotating shafts are mounted on bronze bushings for reduced wear.
- **OPEN CONSTRUCTION** - For easy cleaning and inspection.
- **SAFETY** - One pawl is always engaged with ratchet during lifting and lowering operations. 360° swiveling hooks have safety latches for positive load engagement.
- **LIFETIME WARRANTY**



SPECIFICATIONS

Cable Ratchet Lever Hoist

Model Number	Single Line				Double Line				Cable Specifications		Net Weight (Lbs.)
	Capacity		Lift* (Ft.)	Min. Hdrm. (In.)	Capacity		Lift* (Ft.)	Min. Hdrm. (In.)	Diam. (In.)	Length (Ft.)	
	Lbs.	Tons			Lbs.	Tons					
C105DA	500	1/4	29	21	1000	1/2	14	27	3/16	30	9 1/2
C115SA	1000	1/2	13 3/4	19	— Single Line Only —				3/16	16	7 3/4
C115DA	1000	1/2	13 1/2	21	2000	1	6 1/2	27	3/16	16	9 1/2
C505NA	1500	3/4	13	21	— Single Line Only —				1/4	15	8 1/2
C202WNA	1500	3/4	12 1/2	21	3000	1 1/2	6	27	1/4	15	10 1/2
C434WNA	1500	3/4	21 1/2	22 1/2	3000	1 1/2	10 1/4	28 1/2	1/4	24	12 1/4
C430CDPA	1500	3/4	21 1/2	25	3000	1 1/2	10 1/4	33 1/2	1/4	24	15
C404WNA	2000	1	12 1/2	22 1/2	4000	2	6	28 1/2	9/32	15	12 1/2

1/4 - 2 Ton
Made in USA

* Lift is measured according to ANSI standards, which require two wraps of cable on the drum at all times.

NOTE: For complete dimensional data, refer to Coffing Dimensional Databook.

Incremental Take-Up For Proper Tensioning

A and AD Ratchet Lever Load Binders



COFFING A and AD Models - Roller chain load binders provide quality and durability. Unlike over-center binders, the ratchet and pawl design protects the operator by providing incremental take-up for proper tensioning and securing of the load.

- **CAPACITIES & LIFT** - Rated loads from $\frac{3}{4}$ to $1\frac{1}{2}$ Tons. For standard lift, see chart below.
- **CONVERTIBLE** - Double-chain model converts to single-chain.
- **LIFETIME WARRANTY**

S P E C I F I C A T I O N S

A and AD Ratchet Lever Hoists

$\frac{3}{4}$ - $1\frac{1}{2}$ Ton
Made in USA

Load Limit		Ultimate Strength (Lbs.)	Model	Std. Take-Up (In.)	Strands of Load Chain	Minimum Dist. Betw. Hooks (In.)	Handle Length (In.)	Take-Up Increment (In.)	Net Weight (Lbs.)
Working (Lbs.)	Proof (Lbs.)								
1500	3000	7500	A	19 $\frac{1}{2}$	1	15 $\frac{1}{2}$	19 $\frac{1}{4}$	$\frac{5}{8}$	11 $\frac{1}{2}$
3000	6000	15000	AD	20	2	16 $\frac{3}{4}$	19 $\frac{1}{4}$	$\frac{5}{16}$	14 $\frac{1}{2}$

NOTE: A and AD models feature $\frac{3}{8}$ " roller chain and grab hooks with $\frac{1}{2}$ " throat opening.

NOTE: For complete dimensional data, refer to Coffing Dimensional Databook.

DIMENSIONS

NEW

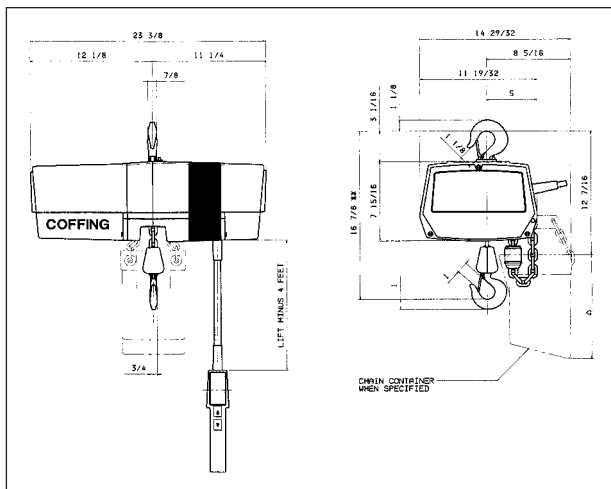

Presenting the companion publication to the Coffing Catalog—*The Coffing Dimensional Databook*. Featuring the latest dimensional drawings and related technical information.

To obtain a copy, please call today.

(704) 853-0095

Only The Toughest Wire Rope Hoists Hang Around Here



The Coffing Wire Rope Hoist Catalog Will Help You Select the Best Wire Rope Hoist For Your Most Demanding Lifting Jobs.

Call us now and we'll send you a copy
(704) 583-0095

High Performance Lifting™
COFFING®
HOISTS

I-Beam Specifications

The following table shows the standard sizes, flange widths and weights for both American Standard and Wide Flange I-beams. I-beams designated with an asterisk (*) denote New Series specifications which conform ASTM A6 standards, effective September 1, 1978.

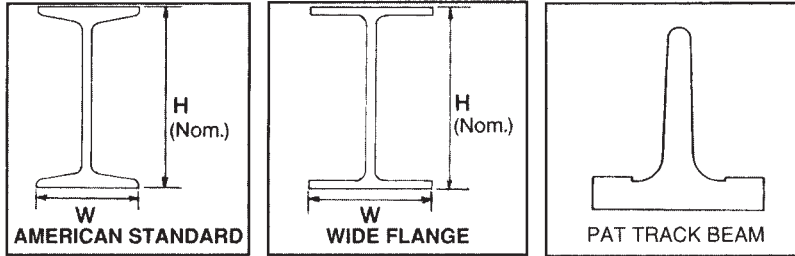

Order Checklist

When ordering a Coffing[®] Hoist Trolley, be sure to include:

Total Rated Load (Lb.)	
Required Trolley Speed (Ft./Min.)†	
Motor Voltage†	
I-Beam Height (In.)	
I-Beam Flange Width (In.)	
I-Beam Weight Per Foot (Lb.)	
Trolley Model Number	
Hoist Model Number	

†MT series trolleys only.

American Standard			Wide Flange								
H (In.)	Weight Per Foot (Lb.)	W (In.)	H (In.)	Weight Per Foot (Lb.)	W (In.)	H (In.)	Weight Per Foot (Lb.)	W (In.)	H (In.)	Weight Per Foot (Lb.)	W (In.)
4	7.7	2.663	6	8.5	3.940	10	77	10.190	16*	50	7.070
4	9.5	2.796	6*	9	4	10*	77	10.190	16*	57	7.120
5	10	3.004	6	12	4	10*	88	10.265	16	58	8.464
5	14.75	3.284	6*	12	4	10	89	10.275	16*	67	10.235
6	12.5	3.332	6	16	4.030	10	100	10.340	16*	77	10.295
6	17.25	3.565	6*	16	4.030	10*	100	10.340	16*	89	10.365
7	15.3	3.662	6*	15	5.990	10	112	10.415	16*	100	10.425
7	20	3.860	6	15.5	5.995	10*	112	10.415	16	88	11.502
8	18.4	4.001	6	20	6.020	12	14	3.968	16	96	11.5
8	23	4.171	6*	20	6.018	12*	14	3.970	18	35	6
10	25.4	4.661	6	25	6.080	12*	16	3.990	18*	35	6
10	35	4.944	6*	25	6.080	12	16.5	4	18	40	6.015
12	31.8	5	8	10	3.940	12	19	4.005	18*	40	6.015
12	35	5.078	8*	10	3.940	12*	19	4.007	18*	46	6.060
12	40.8	5.252	8	13	4	12	22	4.030	18	45	7.477
12	50	5.477	8*	13	4	12*	22	4.030	18	50	7.5
15	42.9	5.501	8	15	4.015	12*	26	6.490	18*	50	7.5
15	50	5.640	8*	15	4.015	12	27	6.497	18	55	7.532
18	54.7	6.001	8	17	5.250	12*	30	6.520	18*	55	7.530
18	70	6.251	8*	18	5.250	12	31	6.525	18	60	7.558
20	65.4	6.25	8	20	5.268	12*	35	6.560	18*	60	7.555
20	75	6.385	8*	21	5.270	12	36	6.565	18*	71	7.635
20	86	7.060	8	24	6.495	12	40	8	18*	64	8.715
20	96	7.200	8*	24	6.5	12*	40	8.005	18	70	8.75
24	79.9	7.001	8	28	6.535	12*	45	8.042	18	77	8.787
24	90	7.125	8*	28	6.535	12*	45	8.045	18*	76	11.035
24	100	7.245	8	31	7.995	12	50	8.077	18*	86	11.090
24	105.9	7.875	8*	31	7.995	12*	50	8.080	18*	97	11.145
24	121	8.050	8	35	8.020	12	53	10	18*	106	11.200
			8*	35	8.020	12*	53	9.995	18*	119	11.265
			8	40	8.070	12	58	10.014	18	96	11.75
			8*	40	8.070	12*	58	10.010	21	44	6.5
			8	48	8.110	14	22	5	21*	44	6.5
			8*	48	8.110	14*	22	5	21*	50	6.530
			8	58	8.220	14	26	5.025	21*	57	6.555
			8*	58	8.220	14	26	5.025	21	55	8.215
			8	67	8.280	14	30	6.730	21*	62	8.240
			8*	67	8.280	14*	30	6.730	21*	62	8.240
			10	11.5	3.950	14	34	6.75	21	68	8.270
			10*	12	3.960	14*	34	6.745	21*	68	8.270
			10	15	4	14	38	6.770	21	73	8.295
			10*	15	4	14*	38	6.770	21*	73	8.295
			10	17	4.010	14	43	8	21*	83	8.355
			10*	17	4.010	14*	43	7.995	21*	93	8.420
			10	19	4.020	14	48	8.031	21	82	8.962
			10*	19	4.020	14*	48	8.030	24	55	7.005
			10	21	5.75	14	53	8.062	24*	55	7.005
			10*	22	5.75	14*	53	8.060	24*	62	7.040
			10	25	5.762	14	61	10	24	68	8.961
			10*	26	5.770	14*	61	9.995	24*	68	8.965
			10	29	5.799	14	68	10.035	24	76	8.985
			10*	30	5.810	14	68	10.035	24*	76	8.990
			10	33	7.960	14	74	10.072	24	84	9.015
			10*	33	7.960	14*	74	10.070	24*	84	9.020
			10	39	7.985	14	78	12	24	94	9.065
			10*	39	7.985	14*	87	14.500	24*	94	9.065
			10	45	8.020	14*	82	10.130			
			10*	45	8.020	16	26	5.5			
			10	49	10	16	31	5.525			
			10*	49	10	16*	31	5.525			
			10	54	10.030	16	36	6.992			
			10*	54	10.030	16*	36	6.985			
			10	60	10.080	16	40	7			
			10*	60	10.080	16*	40	6.995			
			10	66	10.117	16	45	7.039			
			10*	68	10.130	16*	45	7.035			
			10	72	10.170	16	50	7.073			



WARRANTY

Every hoist is thoroughly inspected and tested prior to shipment from the factory. Should any problem develop, return the complete hoist prepaid to your nearest Coffing Hoists Authorized Warranty Repair Station.

If inspection reveals that the problem is caused by defective workmanship or material, repairs will be made without charge and the hoist will be returned, transportation prepaid. This warranty does not apply where: **(1)** deterioration is caused by normal wear, abuse, improper or inadequate power supply, eccentric or side loading, overloading, chemical or abrasive actions, improper maintenance, or excessive heat; **(2)** problems resulted from repairs, modifications, or alterations made by persons other than factory or Coffing Authorized Warranty Repair Station personnel; **(3)** the hoist has been abused or damaged as a result of an accident; **(4)** repair parts or accessories other than those supplied by Coffing Hoists are used on the hoist. Equipment and accessories not of the seller's manufacture are warranted by the manufacturer. Except as stated herein, Coffing Hoists makes no other warranties, express or implied, including warranties of merchantability and fitness for a particular purpose.





COFFING[®] HOISTS

Country Club Road • P.O. Box 779
Wadesboro, NC 28170 USA

Phone: (800) 477-5003 (704) 694-2156
FAX: (800) 374-6853 (704) 694-6829

AWARNING

The equipment shown in this publication is intended for industrial use only and should not be used to lift, support, or otherwise transport people, or to suspend loads over people.