

WIRING DIAGRAMS FOR BRIDGE CONTROL PANELS

Bridge W/D's

		Panel Part #	Page No.
Nema-4/12	1-Speed	444231-**	2
Nema-4/12	1-Speed with Soft-Start	444711-**	3
Nema-4/12	2-Speed	444232-**	4
Nema-4/12	2-Speed with Soft-Start	444712-**	5
Nema-4/12	V.F.C. P3 thru 10 hp	448550-**	6
Nema-4/12	V.F.C. G+ thru 30 hp	445351-**	7
Nema-1	1-Speed	446003-**	8
Nema-1	2-Speed	446003-**	9
Nema-1	1-Phase	446003-**	10
	Typical Interconnection M-1H-1T-1B P.B. from Trolley	11	
	Typical Interconnection M-1H-1T-1B P.B. from Bridge	12	
	Typical Interconnection M-2H-2T-2B P.B. from Trolley	13	
	Typical Interconnection M-2H-2T-2B P.B. from Bridge	14	



WIRE #	DEVICE CONNECTED
RL1	DISC
RL2	DISC
RL3	DISC
ML1	DISC, M, MPFU
ML2	DISC, M, MPFU
ML3	DISC, M
MP1	MPFU, MCPT
MP2	MPFU, MCPT
L1	M, BFU
L2	M, BFU
L3	M, BFU
BL1	BFU, F-R
BL2	BFU, F-R
BL3	BFU, F-R
BT1	F-R
BT2	F-R
BT3	F-R
20	R, F
21	F, F
21A	F, R
28	BT2
29	R, F
90	MCFU, M
M91	BT1, M
92	MCPT, G, M
93	BT1, M
BB1	F-R
BB2	F-R

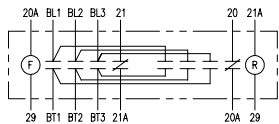
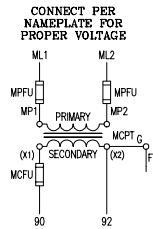
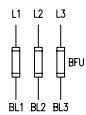
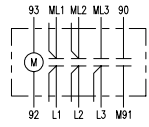
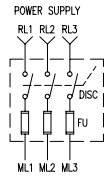

SYMBOL DESIGNATIONS

- DISC - POWER DISCONNECT SWITCH
- M - MAINLINE CONTACTOR
- BFU - BRIDGE MOTOR CIRCUIT FUSING
- MCPT - CONTROL CIRCUIT TRANSFORMER
- MPFU - CONTROL CIRCUIT PRIMARY FUSING
- MCFU - CONTROL CIRCUIT SECONDARY FUSING
- F - BRIDGE FORWARD CONTACTOR
- R - BRIDGE REVERSE CONTACTOR
- BT - TERMINAL BOARD
- BTAS - BRIDGE MOTOR TEMPERATURE ACTUATED SWITCH
- G - FRAME GROUND



WARNING:
THIS EQUIPMENT MUST BE EFFECTIVELY GROUNDED
ACCORDING TO APPLICABLE CODES.

ELEMENTARY DIAGRAM

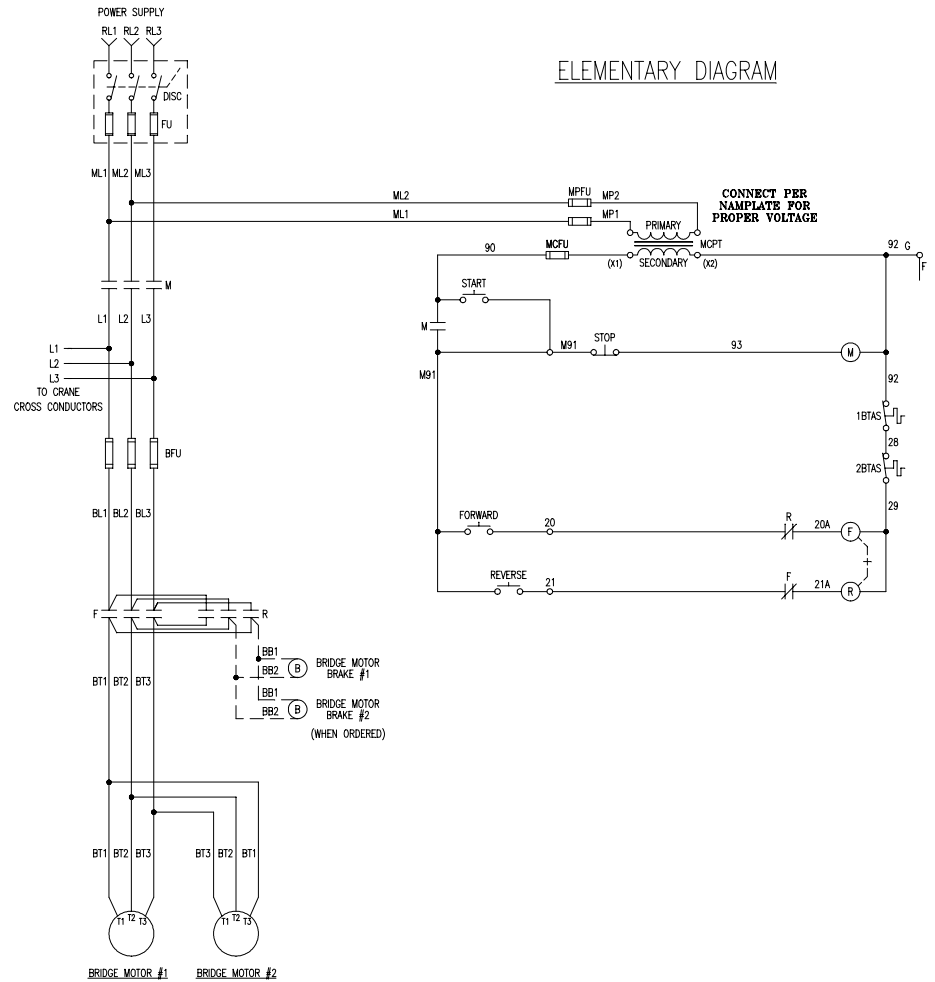

WIRE #	DEVICE CONNECTED
RL1	DISC
RL2	DISC
RL3	DISC
ML1	DISC, M, MPFU
ML2	DISC, M, MPFU
ML3	DISC, M
MP1	MPFU, MCPT
MP2	MPFU, MCPT
L1	M, BFU
L2	M, BFU
L3	M, BFU
BL1	BFU, F-R
BL2	BFU, F-R
BL3	BFU, F-R
ST1	F-R, SS
ST2	F-R, SS
ST3	F-R, SS
BT1	SS
BT2	SS
BT3	SS
20	TB1 R
20A	R, F, SS
21	F
21A	F, R, SS
28	R, F, SS
29	R, F, SS
90	TB2 MCFU, M
M91	M, SS
92	TB2 MCPT, G, M
93	M
BB1	TB1 F-R
BB2	TB1 F-R

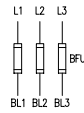
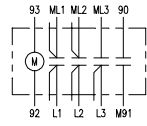
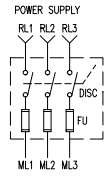

CONNECT PER NAMEPLATE FOR PROPER VOLTAGE

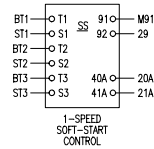
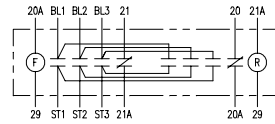
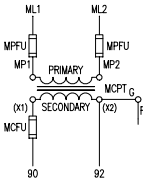

SYMBOL DESIGNATIONS
 DISC - POWER DISCONNECT SWITCH
 M - MAINLINE CONTACTOR
 BFU - BRIDGE MOTOR CIRCUIT FUSING
 MCPT - CONTROL CIRCUIT TRANSFORMER
 MPFU - CONTROL CIRCUIT PRIMARY FUSING
 MCFU - CONTROL CIRCUIT SECONDARY FUSING
 F - BRIDGE FORWARD CONTACTOR
 R - BRIDGE REVERSE CONTACTOR
 SS - SOFT-START ELECTRONIC MODULE
 BTAS - BRIDGE MOTOR TEMPERATURE ACTUATED SWITCH
 TB - TERMINAL BOARD
 G - FRAME GROUND
 F



WARNINGS:
 THIS EQUIPMENT MUST BE EFFECTIVELY GROUNDED ACCORDING TO APPLICABLE CODES.

ELEMENTARY DIAGRAM

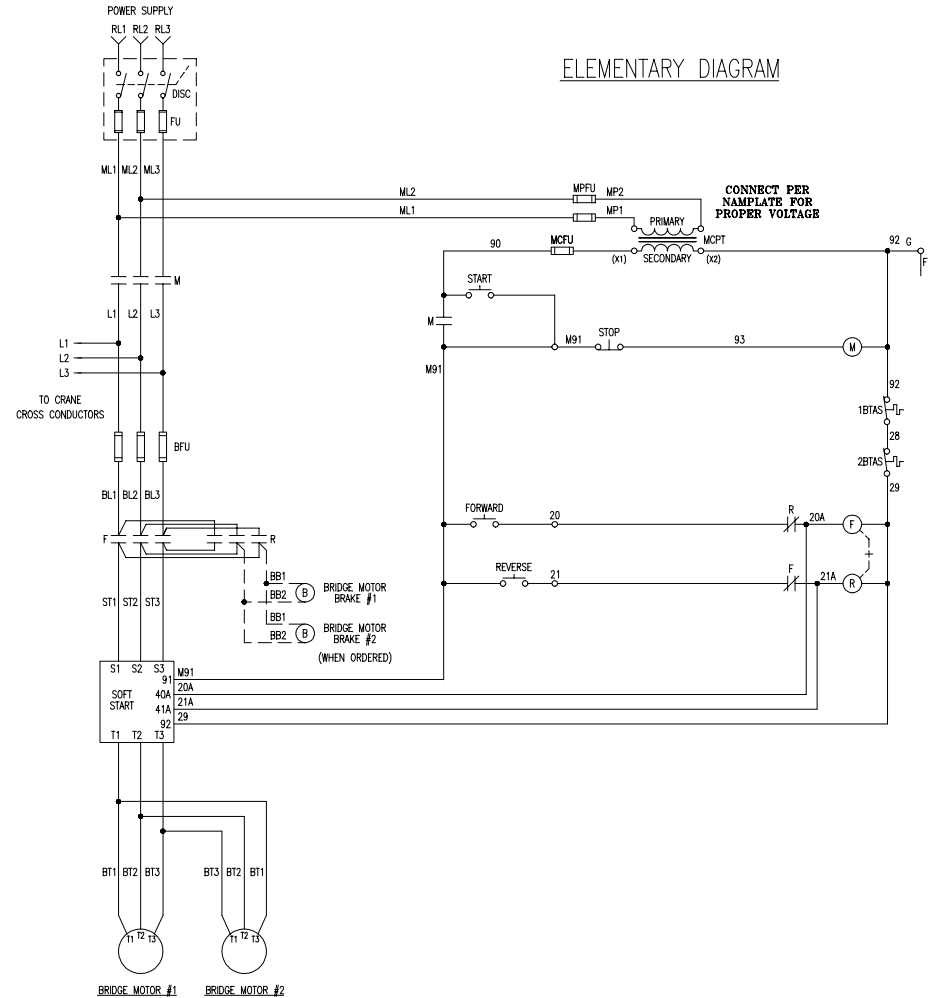

WIRE #	DEVICE CONNECTED
RL1	DISC
RL2	DISC
RL3	DISC
ML1	DISC, M, MPFU
ML2	DISC, M, MPFU
ML3	DISC, M
MP1	MPFU, MCPT
MP2	MPFU, MCPT
L1	M, BFU
L2	M, BFU
L3	M, BFU
BL1	BFU, F-R
BL2	BFU, F-R
BL3	BFU, F-R
G	F-R, FB
J	F-R, FB
BT1	FB
BT2	F-R
BT3	FB
BT11	FB
BT12	F-R
BT13	FB
20	R
20A	R, F
21	TB2
21A	F, R
22	TB2
28	FB
29	F, R, FB
90	TB1, MCFU, M
M91	M, MCPT, G, M
92	TB1
93	TB1
BB1	TB2
BB2	TB2
	F-R

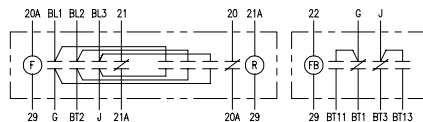
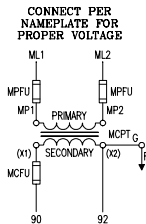
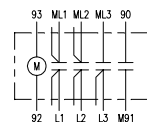
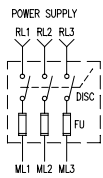

SYMBOL DESIGNATIONS

- DISC - POWER DISCONNECT SWITCH
- M - MAINLINE CONTACTOR
- BFU - BRIDGE MOTOR CIRCUIT FUSING
- MCPCT - CONTROL CIRCUIT TRANSFORMER
- MPFU - CONTROL CIRCUIT PRIMARY FUSING
- MCFU - CONTROL CIRCUIT SECONDARY FUSING
- F - BRIDGE FORWARD CONTACTOR
- R - BRIDGE REVERSE CONTACTOR
- FB - BRIDGE FAST SPEED CONTACTOR
- TB - TERMINAL BOARD
- BTAS - BRIDGE MOTOR TEMPERATURE ACTUATED SWITCH
- G - FRAME GROUND
- F -

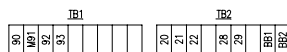

WARNING:
THIS EQUIPMENT MUST BE EFFECTIVELY GROUNDED
ACCORDING TO APPLICABLE CODES.

CONNECT PER
NAMEPLATE FOR
PROPER VOLTAGE

ELEMENTARY DIAGRAM

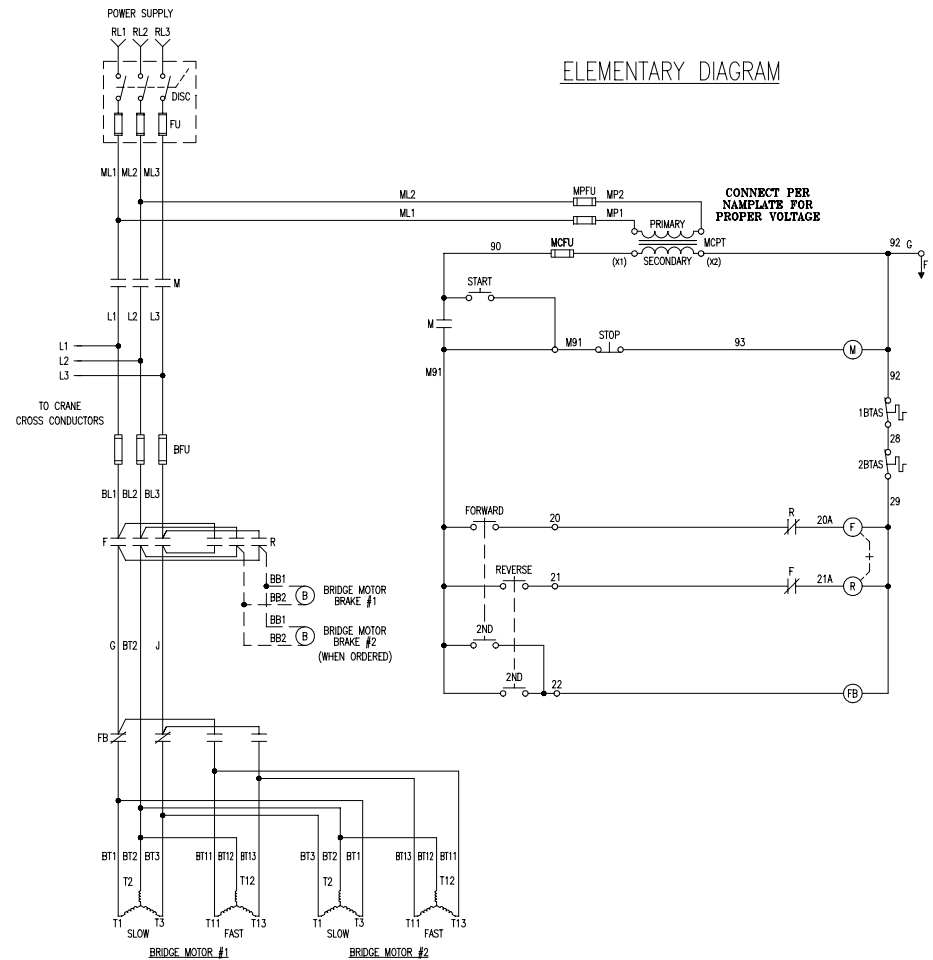

CONNECT PER
NAMEPLATE FOR
PROPER VOLTAGE

WIRE #	DEVICE CONNECTED
RL1	DISC
RL2	DISC
RL3	DISC
ML1	DISC, M, MPFU
ML2	DISC, M, MPFU
ML3	DISC, M, MPFU
MP1	MPFU, MCPT
MP2	MPFU, MCPT
L1	M, BFU
L2	M, BFU
L3	M, BFU
BL1	BFU, F-R
BL2	BFU, F-R
BL3	BFU, F-R
ST1	F-R, SS
ST2	F-R, SS
ST3	F-R, SS
G	SS, FB
J	SS, FB
BT1	FB
BT2	SS
BT3	FB
BT11	FB
BT12	SS
BT13	FB
20	TB1 R
20A	R, F, SS
21A	TB1 F, R, SS
22	TB1 FB, SS
28	TB1
29	TB1 F, R, FB, SS
90	TB2 MCFU, M
M91	TB2 M, SS
92	TB2 MCPT, G, M
93	TB2 M
BB1	TB2 F-R
BB2	TB2 F-R

SYMBOL DESIGNATIONS

- DISC - POWER DISCONNECT SWITCH
- M - MAINLINE CONTACTOR
- BFU - BRIDGE MOTOR CIRCUIT FUSING
- MCPT - CONTROL CIRCUIT TRANSFORMER
- MPFU - CONTROL CIRCUIT PRIMARY FUSING
- MCFU - CONTROL CIRCUIT SECONDARY FUSING
- F - BRIDGE FORWARD CONTACTOR
- R - BRIDGE REVERSE CONTACTOR
- SS - SOFT-START ELECTRONIC MODULE
- FB - BRIDGE FAST SPEED CONTACTOR
- TB - TERMINAL BOARD
- BTAS - BRIDGE MOTOR TEMPERATURE ACTUATED SWITCH
- G - FRAME GROUND
- F -

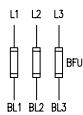
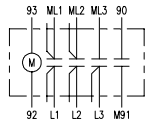
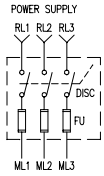

CONNECT PER NAMEPLATE FOR PROPER VOLTAGE

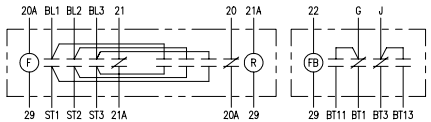
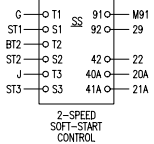
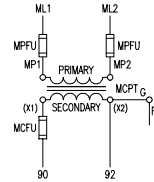

WARNING:
THIS EQUIPMENT MUST BE EFFECTIVELY GROUND
ACCORDING TO APPLICABLE CODES.

ELEMENTARY DIAGRAM

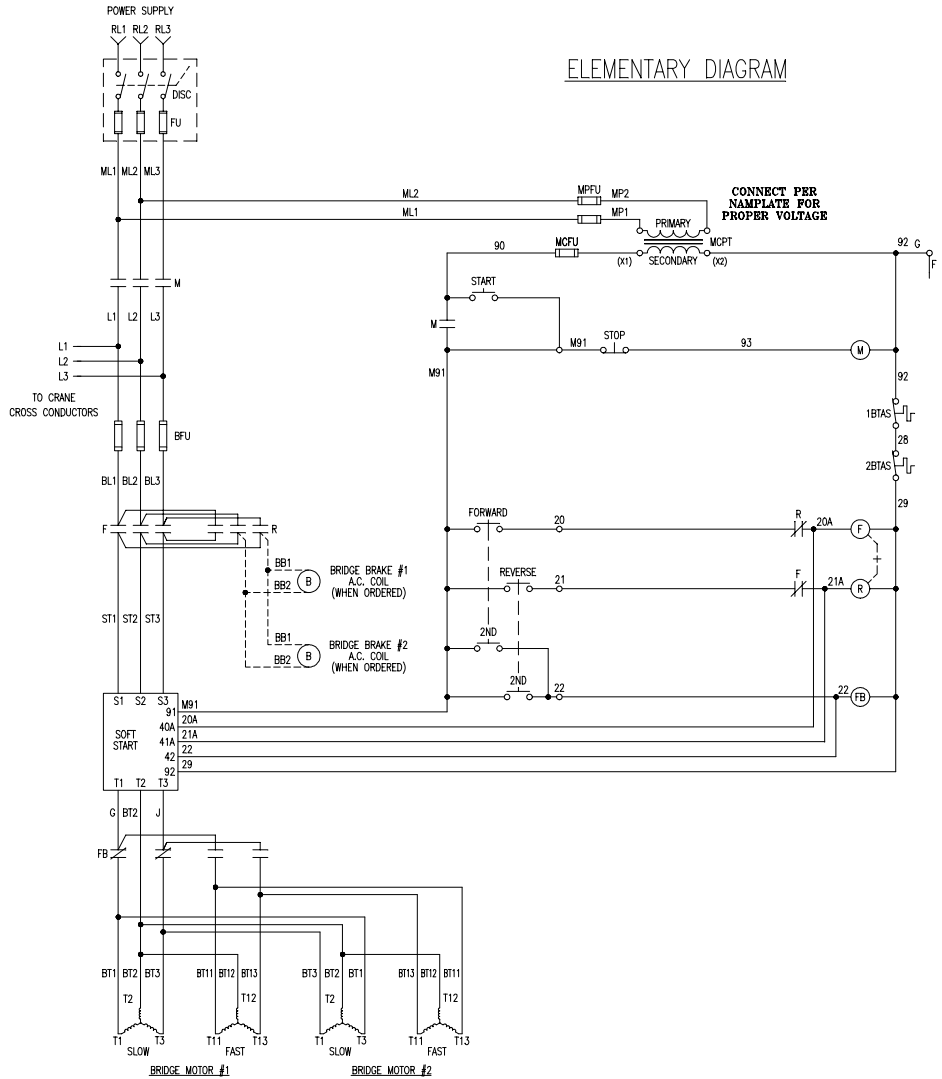

WIRE #	DEVICE CONNECTED
RL1	DISC
RL2	DISC
RL3	DISC
ML1	FU, M, MPFU
ML2	FU, M, MPFU
ML3	FU, M
L1	M, BFU
L2	M, BFU
L3	M, BFU
BL1	BFU, INVERTER, BB
BL2	BFU, INVERTER, BB
BL3	BFU, INVERTER
BT1	INVERTER
BT2	INVERTER
BT3	INVERTER
MP1	MPFU, MCPT
MP2	MPFU, MCPT
20	TB INTERFACE CARD
21	TB INTERFACE CARD
22	TB INTERFACE CARD
23	TB INTERFACE CARD
24	TB INTERFACE CARD
25	TB INTERFACE CARD
27	TB BRAKE OUTPUT RELAY, BB, SA20
28	TB
29	TB INTERFACE CARD
90	TB MCPU, M
M91	TB M, BRAKE OUTPUT RELAY
92	TB MCPT, M, SA90, BB, SA20
93	TB M, SA90
BB1	TB BB
BB2	TB BB
BDB1	TB INVERTER
BDB2	TB INVERTER

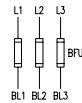
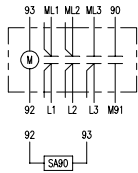
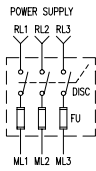

CONNECT PER NAMEPLATE FOR PROPER VOLTAGE

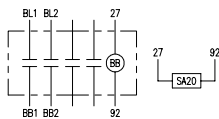
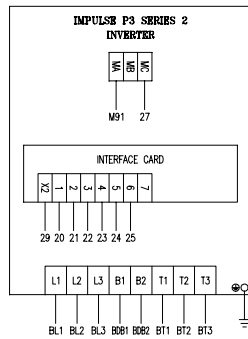
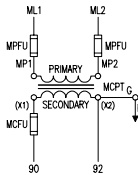

TB
20
21
22
23
24
25
27
28
29
90
92

TB
93
M91
BB1
BB2
BDB1
BDB2
BT1
BT2
BT3

WARNING:
THIS EQUIPMENT MUST BE EFFECTIVELY GROUNDING ACCORDING TO APPLICABLE CODES.

SYMBOL DESIGNATIONS
 DISC - POWER DISCONNECT SWITCH
 FU - MAIN FUSES
 M - MAINLINE CONTACTOR
 MPFU - TRANSFORMER PRIMARY FUSING
 MCPT - CONTROL CIRCUIT TRANSFORMER
 MCPU - CONTROL CIRCUIT FUSE
 BFU - BRIDGE MOTOR CIRCUIT FUSING
 BB - BRIDGE BRAKE RELAY
 BDBR - DYNAMIC BRAKING RESISTOR
 1BTAS/2BTAS - MOTOR TEMPERATURE ACTIVATED SWITCH
 SA - SURGE ABSORBER
 TB - TERMINAL BOARD
 G - FRAME GROUND.
 F

ELEMENTARY DIAGRAM

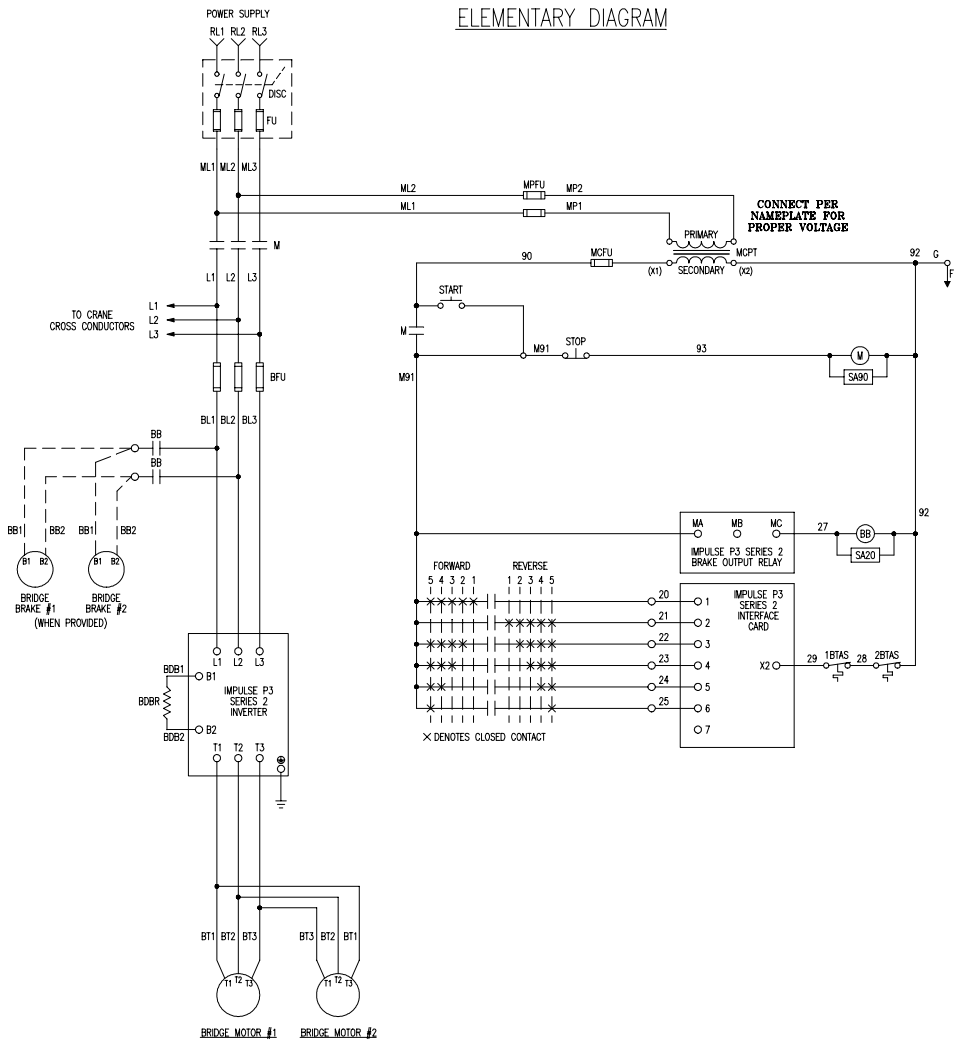

WIRE #	DEVICE CONNECTED
RL1	DISC
RL2	DISC
RL3	DISC
ML1	FU, M, MPFU
ML2	FU, M, MPFU
ML3	M, BFU
L1	M, BFU
L2	M, BFU
L3	M, BFU
BL1	BFU, INVERTER, BB
BL2	BFU, INVERTER, BB
BL3	BFU, INVERTER
BT1	INVERTER
BT2	INVERTER
BT3	INVERTER
MP1	MPFU, MCPT
MP2	MPFU, MCPT
20	TB1 INTERFACE CARD
21	TB1 INTERFACE CARD
22	TB1 INTERFACE CARD
23	TB1 INTERFACE CARD
24	TB1 INTERFACE CARD
25	TB1 INTERFACE CARD
27	TB1 INTERFACE CARD, BB, S20
28	TB1 INTERFACE CARD
29	TB2 MCFU, M
90	MCFU, M
M91	M, INTERFACE CARD
92	TB2 MCPT, G, M, S90, BB, S20
93	TB2 M, S90
1B1	BB
1B2	BB
2B1	BB
2B2	BB

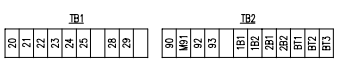
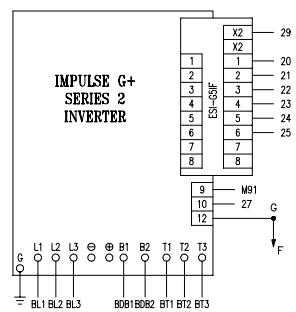
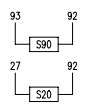
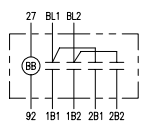
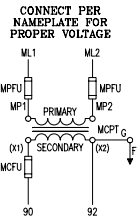
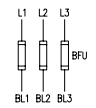
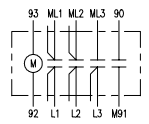
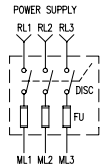

- SYMBOL DESIGNATIONS**
- DISC - POWER DISCONNECT SWITCH
 - FU - MAIN FUSES
 - M - MAINLINE CONTACTOR
 - MPFU - TRANSFORMER PRIMARY FUSING
 - MCPT - CONTROL CIRCUIT TRANSFORMER
 - MCFU - CONTROL CIRCUIT FUSE
 - BFU - BRIDGE MOTOR CIRCUIT FUSING
 - BB - BRIDGE BRAKE RELAY
 - DBR - DYNAMIC BRAKING RESISTOR
 - 1BTAS/2BTAS - MOTOR TEMPERATURE ACTIVATED SWITCH
 - S90 - SURGE ABSORBER FOR MAINLINE CONTACTOR
 - S20 - SURGE ABSORBER FOR BRAKE RELAY
 - TB - TERMINAL BOARD
 - G - FRAME GROUND
 - F -

NOTE: THIS WIRING DIAGRAM SHOWS 5 SPEED CONTROL. THE INVERTER PROGRAMMING IS SETUP FOR 2 SPEED/STEP INFINITELY VARIABLE. CONSULT THE G+ SERIES 2 MANUAL FOR ADDITIONAL PROGRAMMING FEATURES.

WARNING: THIS EQUIPMENT MUST BE EFFECTIVELY GROUNDED ACCORDING TO APPLICABLE CODES.

ELEMENTARY DIAGRAM

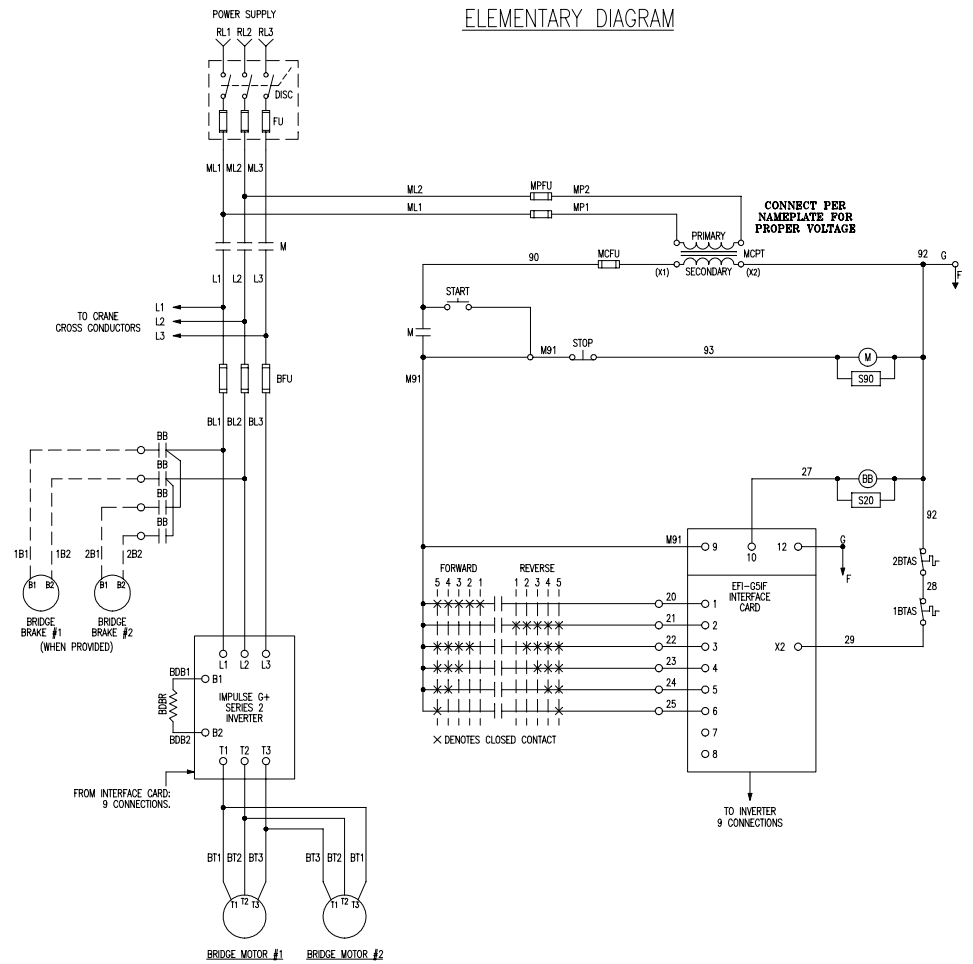

ELEMENTARY DIAGRAM

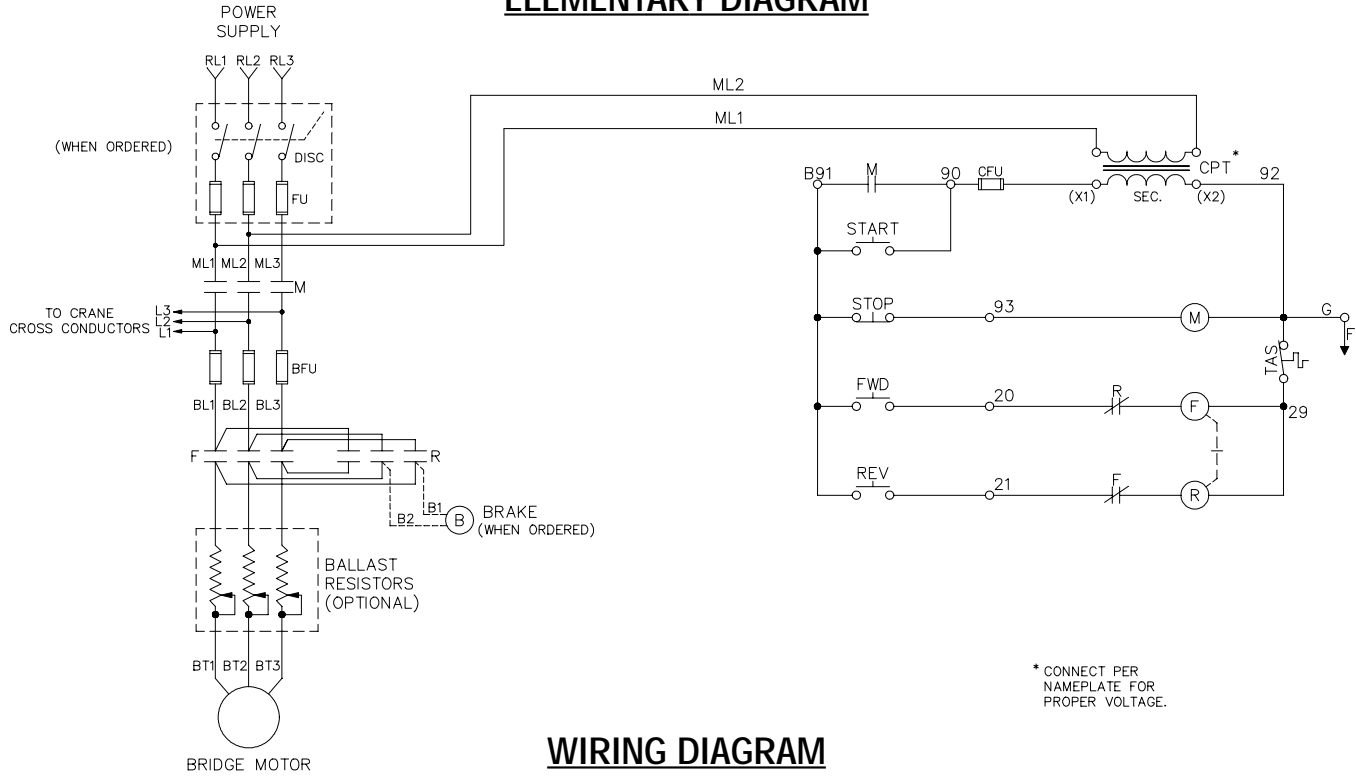

* CONNECT PER NAMEPLATE FOR PROPER VOLTAGE.

WIRING DIAGRAM

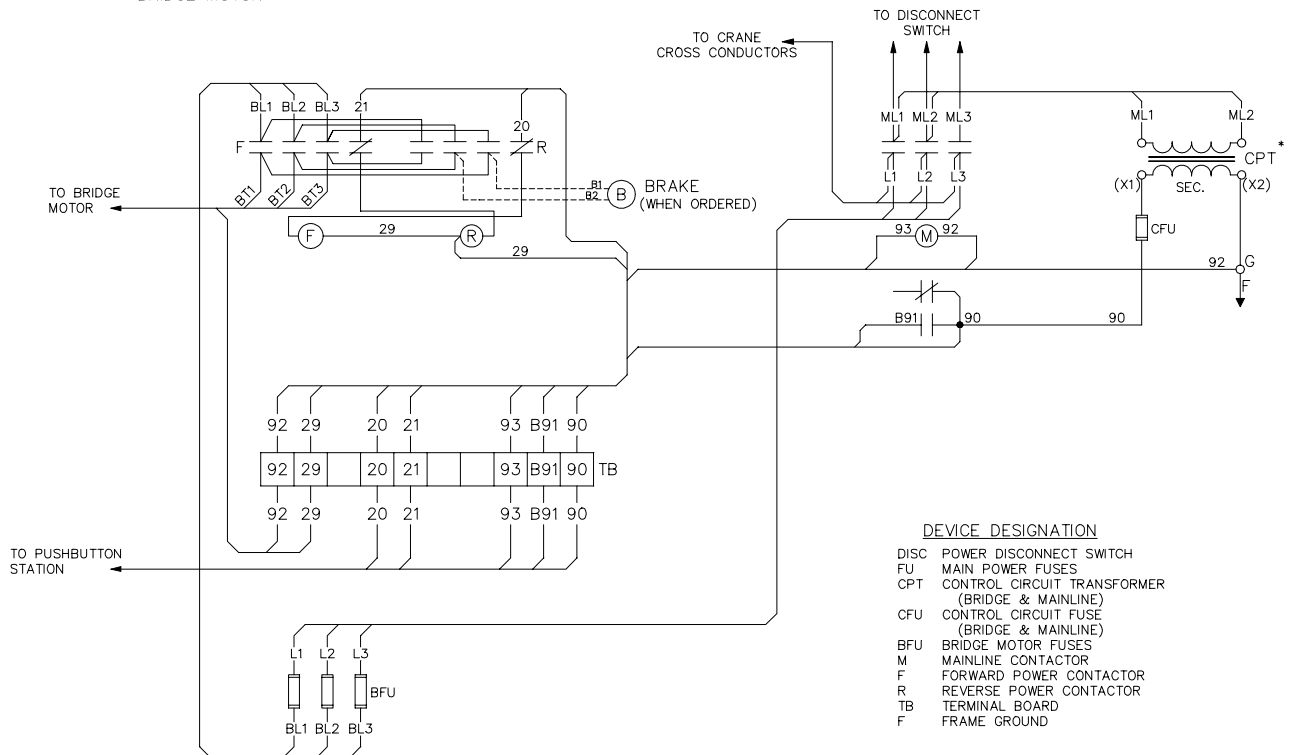

DEVICE DESIGNATION

DISC	POWER DISCONNECT SWITCH
FU	MAIN POWER FUSES
CPT	CONTROL CIRCUIT TRANSFORMER (BRIDGE & MAINLINE)
CFU	CONTROL CIRCUIT FUSE (BRIDGE & MAINLINE)
BFU	BRIDGE MOTOR FUSES
M	MAINLINE CONTACTOR
F	FORWARD POWER CONTACTOR
R	REVERSE POWER CONTACTOR
TB	TERMINAL BOARD
F	FRAME GROUND

WARNING
THIS EQUIPMENT MUST BE EFFECTIVELY GROUNDED ACCORDING TO APPLICABLE CODES.

AVERTISSEMENT
CET EQUIPEMENT DOIT ETRE MIS A LA TERRE EN ACCORDANCE AVEC LES NORMES EN VIGUEUR.

SINGLE SPEED

ELEMENTARY DIAGRAM

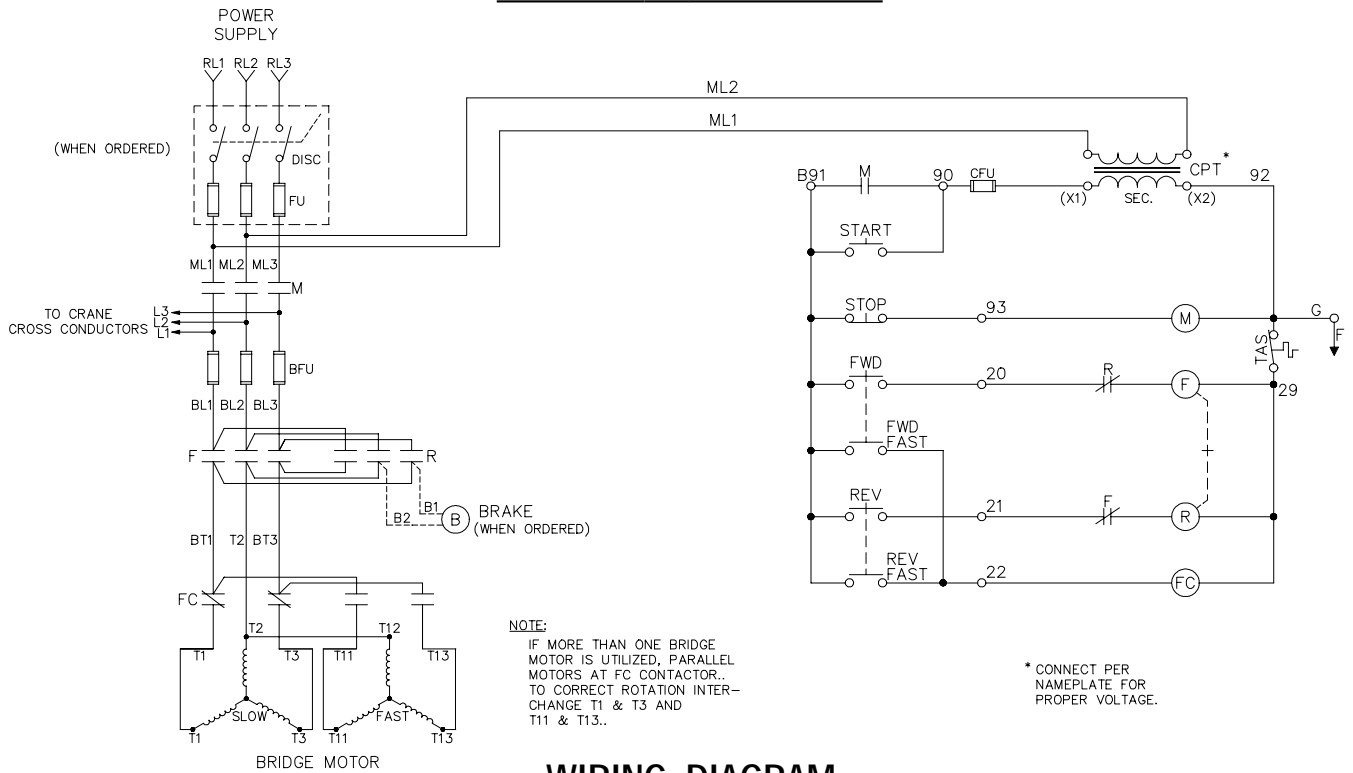

WIRING DIAGRAM

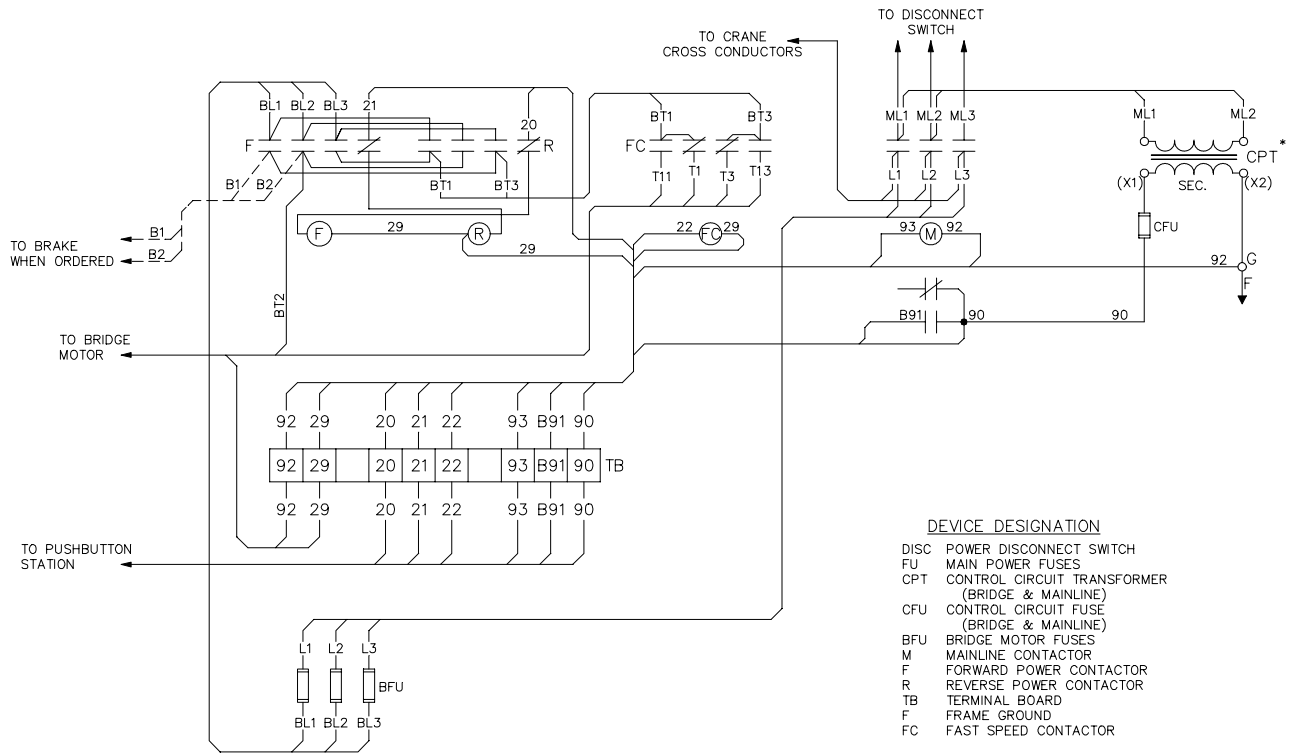

DEVICE DESIGNATION

- DISC POWER DISCONNECT SWITCH
- FU MAIN POWER FUSES
- CPT CONTROL CIRCUIT TRANSFORMER (BRIDGE & MAINLINE)
- CFU CONTROL CIRCUIT FUSE (BRIDGE & MAINLINE)
- BFU BRIDGE MOTOR FUSES (BRIDGE & MAINLINE)
- M MAINLINE CONTACTOR
- F FORWARD POWER CONTACTOR
- R REVERSE POWER CONTACTOR
- TB TERMINAL BOARD
- F FRAME GROUND
- FC FAST SPEED CONTACTOR

WARNING

THIS EQUIPMENT MUST BE EFFECTIVELY GROUNDED ACCORDING TO APPLICABLE CODES.

TWO SPEED

AVERTISSEMENT

CET EQUIPEMENT DOIT ETRE MIS A LA TERRE EN ACCORDANCE AVEC LES NORMES EN VIGUEUR.

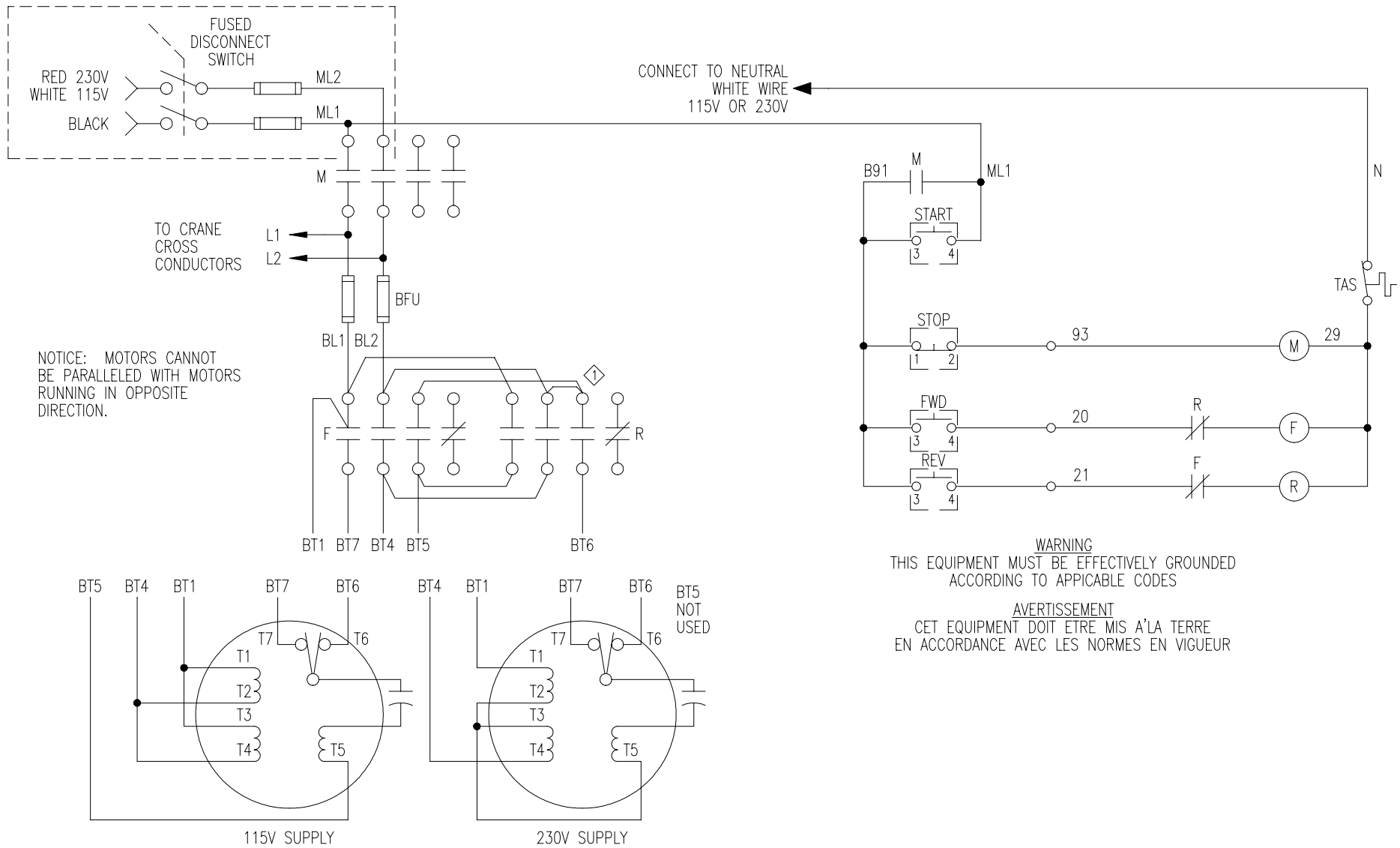

NOTICE: MOTORS CANNOT BE PARALLELED WITH MOTORS RUNNING IN OPPOSITE DIRECTION.

WARNING
THIS EQUIPMENT MUST BE EFFECTIVELY GROUNDED
ACCORDING TO APPLICABLE CODES

AVERTISSEMENT
CET EQUIPEMENT DOIT ETRE MIS A'LA TERRE
EN ACCORDANCE AVEC LES NORMES EN VIGUEUR

**Elementary Diagram Bridge-Mainline
Single Phase**

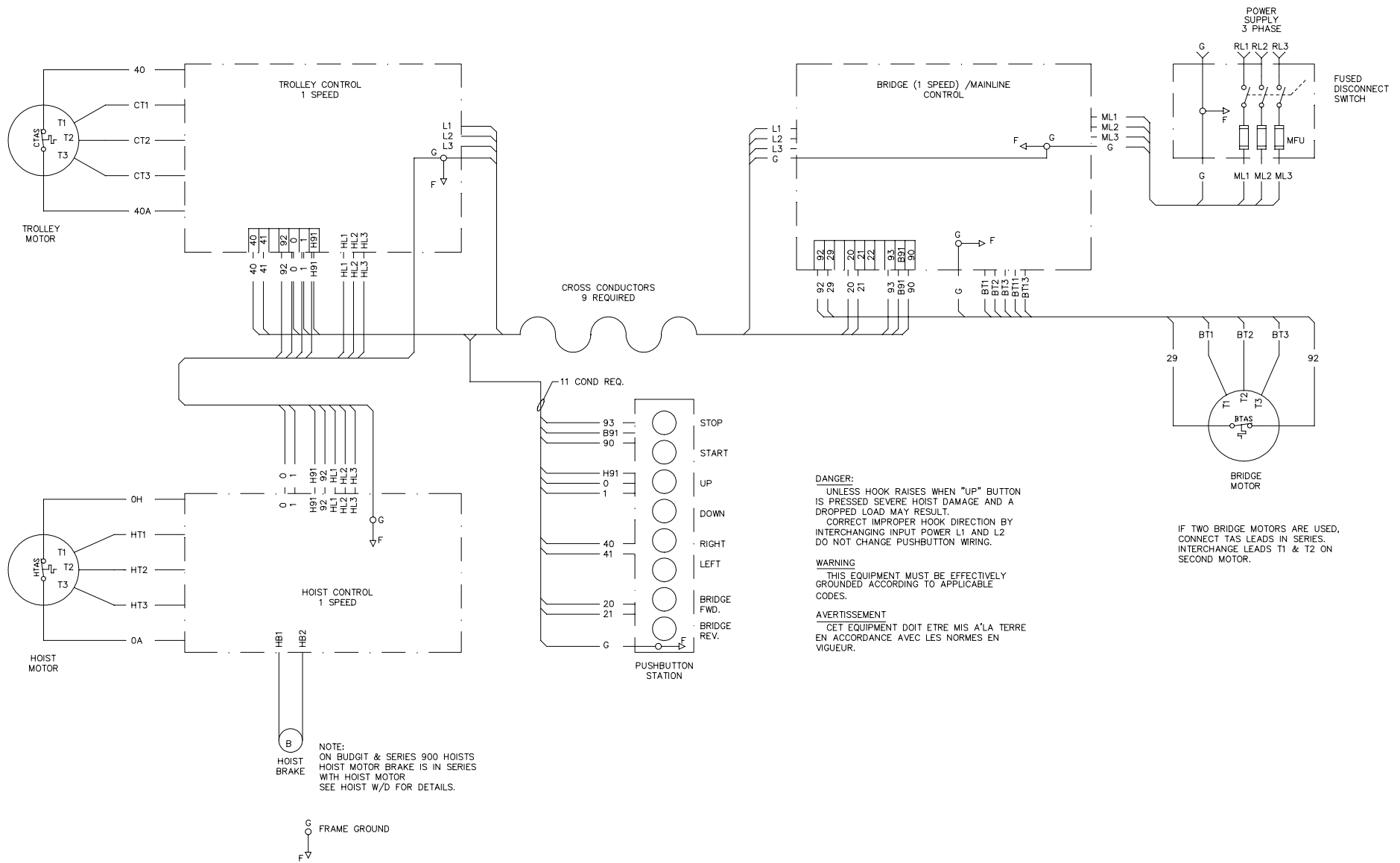

**Interconnection Diagram
1 Speed Hoist, 1 Speed Trolley, 1 Speed Bridge
Pushbutton from Trolley**

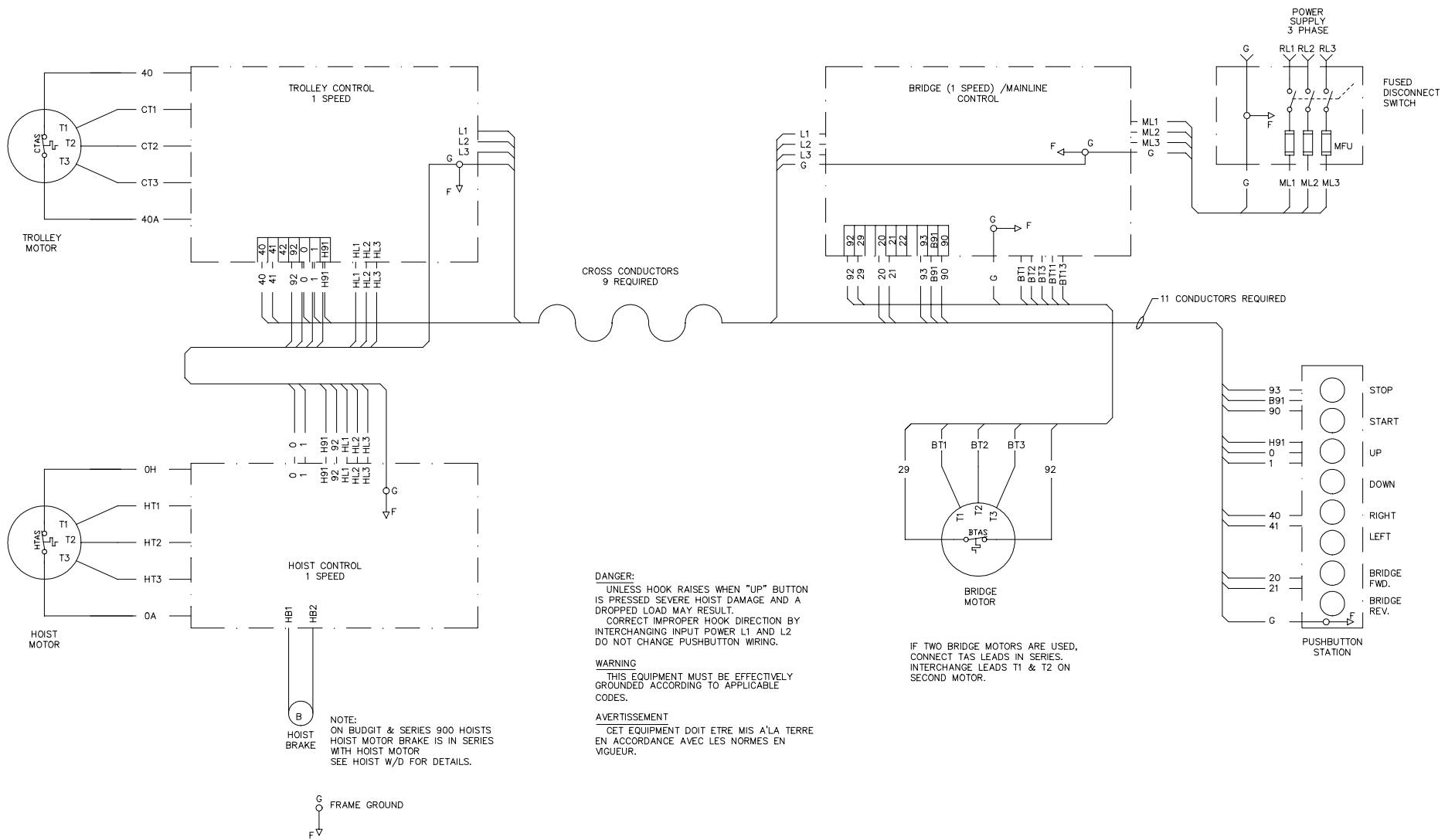

**Interconnection Diagram
1 Speed Hoist, 1 Speed Trolley, 1 Speed Bridge
Pushbutton from Bridge**

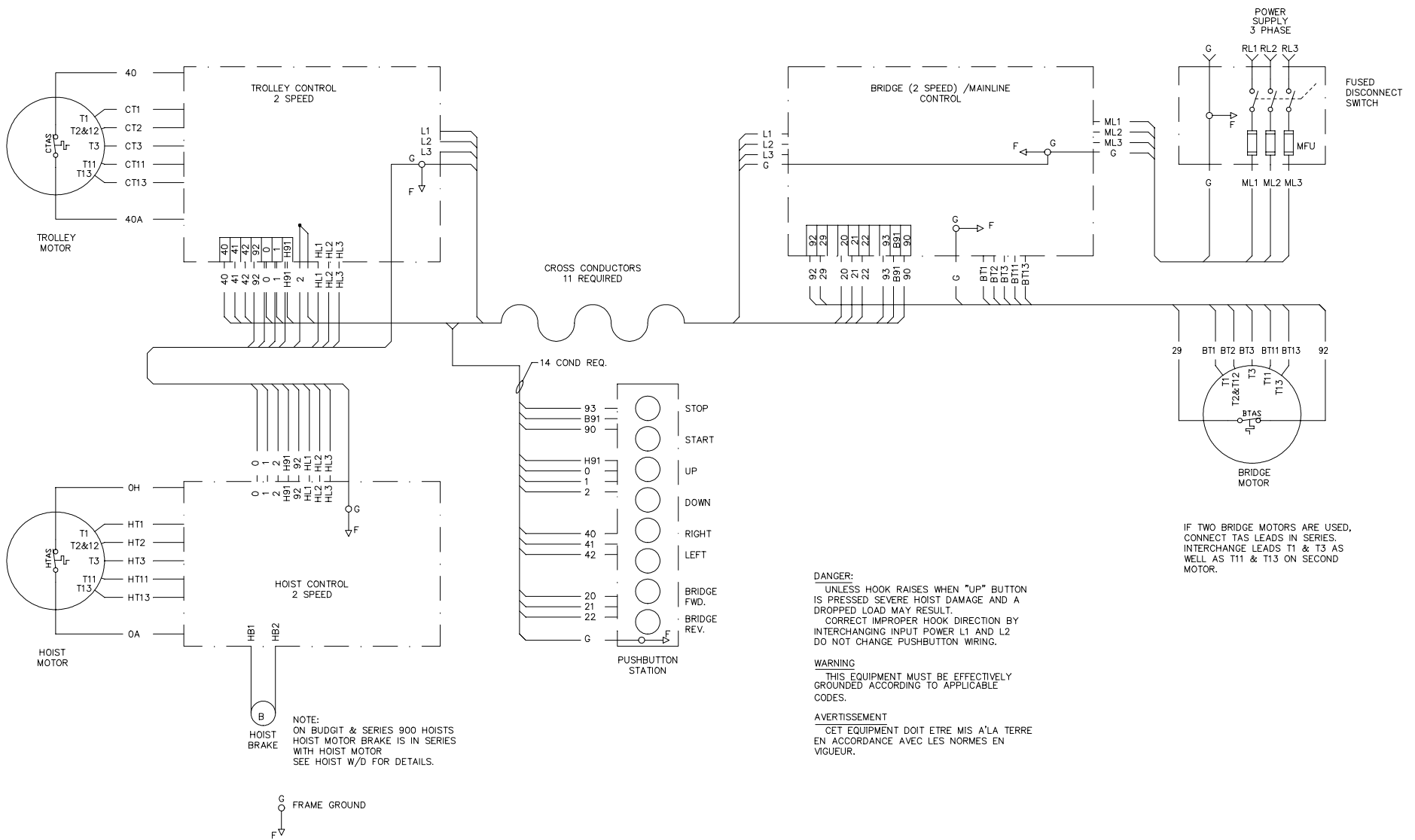

**Interconnection Diagram
2 Speed Hoist, 2 Speed Trolley, 2 Speed Bridge
Pushbutton from Trolley**

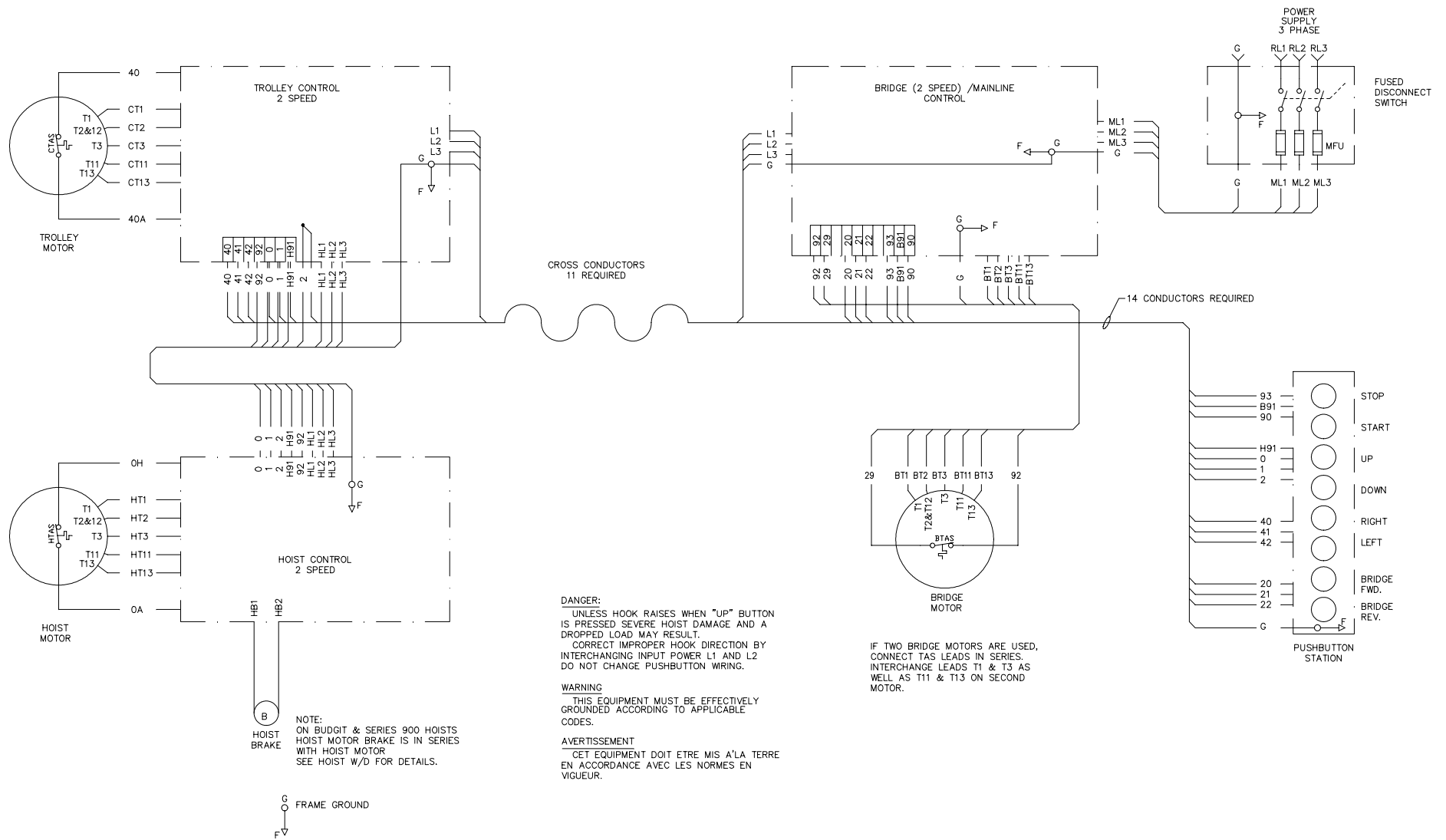

**Interconnection Diagram
2 Speed Hoist, 2 Speed Trolley, 2 Speed Bridge
Pushbutton from Bridge**

For the location of your nearest repair station

Yale•Lift-Tech
P.O. Box 769
Muskegon, MI 49443-0769

Phone: **800 742-9269**
Fax: **800 742-9270**

WARRANTY

WARRANTY AND LIMITATION OF REMEDY AND LIABILITY

A. Seller warrants that its products and parts, when shipped, and its work (including installation, construction and start-up), when performed, will meet applicable specifications, will be of good quality and will be free from defects in material and workmanship. All claims for defective products or parts under this warranty must be made in writing immediately upon discovery and, in any event, within one (1) year from shipment of the applicable item unless Seller specifically assumes installation, construction or start-up responsibility. All claims for defective products or parts when Seller specifically assumes installation, construction or start-up responsibility, and all claims for defective work must be made in writing immediately upon discovery and, in any event, within one (1) year from completion of the applicable work by Seller, provided, however, all claims for defective products and parts made in writing no later than eighteen (18) months after shipment. Defective items must be held for Seller's inspection and returned to the original f.o.b. point upon request. **THE FOREGOING IS EXPRESSLY IN LIEU OF ALL OTHER WARRANTIES WHATSOEVER, EXPRESS, IMPLIED AND STATUTORY, INCLUDING, WITHOUT LIMITATION, THE IMPLIED WARRANTIES OF MERCHANTABILITY AND FITNESS.**

B. Upon Buyer's submission of a claim as provided above and its substantiation, Seller shall at its option either (i) repair or replace its product, part or work at either the original f.o.b. point of delivery or at Seller's authorized service station nearest Buyer or (ii) refund an equitable portion of the purchase price.

C. This warranty is contingent upon Buyer's proper maintenance and care of Seller's products, and does not extend to normal wear and tear. Seller reserves the right to void warranty in event of Buyer's use of inappropriate materials in the course of repair or maintenance, or if Seller's products have been dismantled prior to submission to Seller for warranty inspection.

D. The foregoing is Seller's only obligation and Buyer's exclusive remedy for breach of warranty, and is Buyer's exclusive remedy hereunder by way of breach of contract, tort, strict liability or otherwise. In no event shall Buyer be entitled to or Seller liable for incidental or consequential damages. Any action for breach of this agreement must be commenced within one (1) year after the cause of action has accrued.