

NH SERIES
Hand Hoist

Parts and Instruction
Manual

Yale®

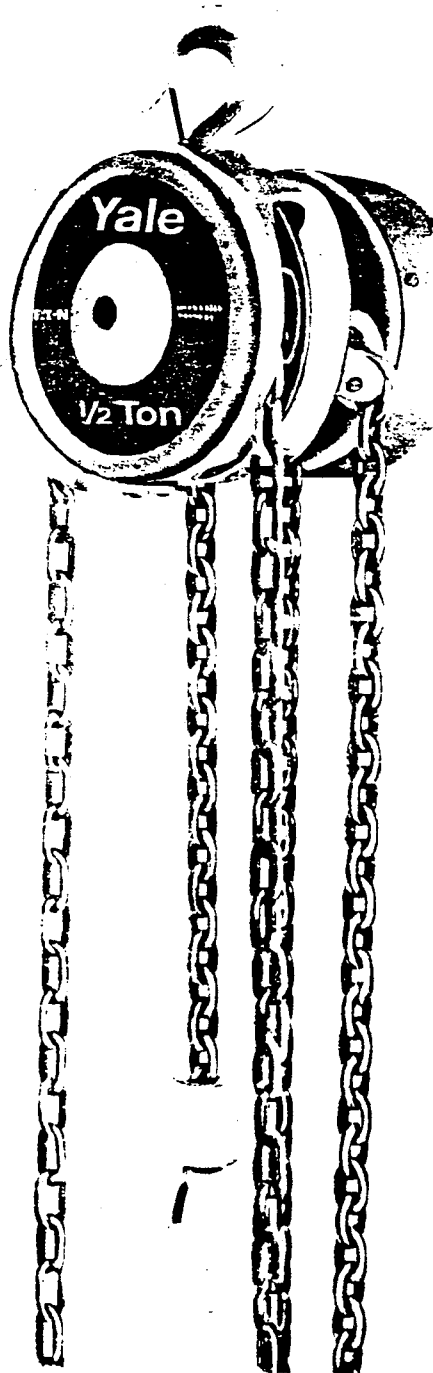

Hoist Unit - NH Series

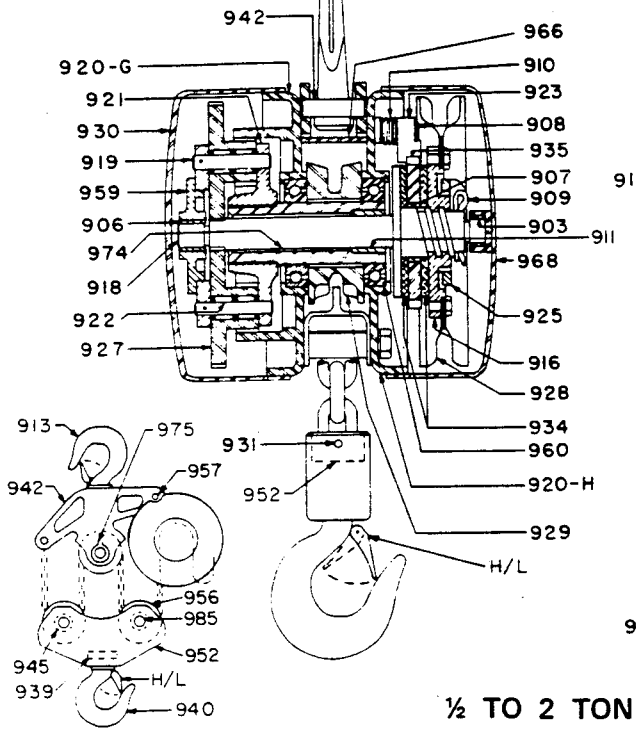
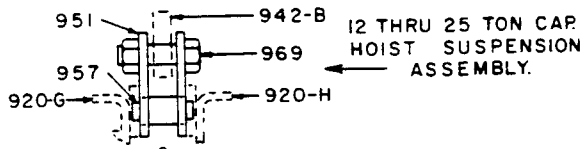

1/2 TO 2 TON

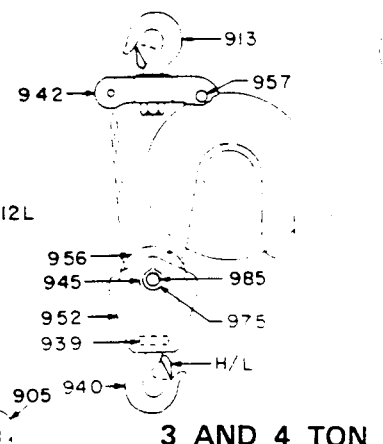

3 AND 4 TON

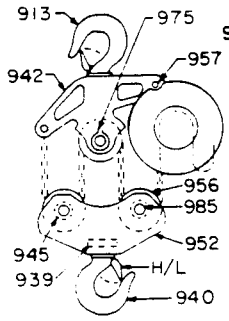

8 TON

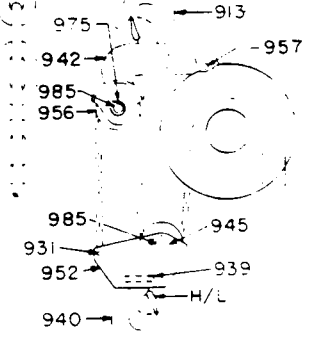

5 AND 6 TON

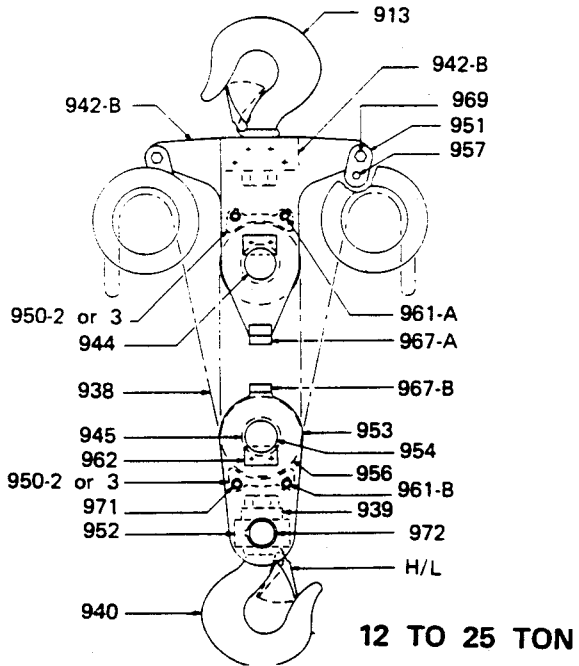

12 TO 25 TON

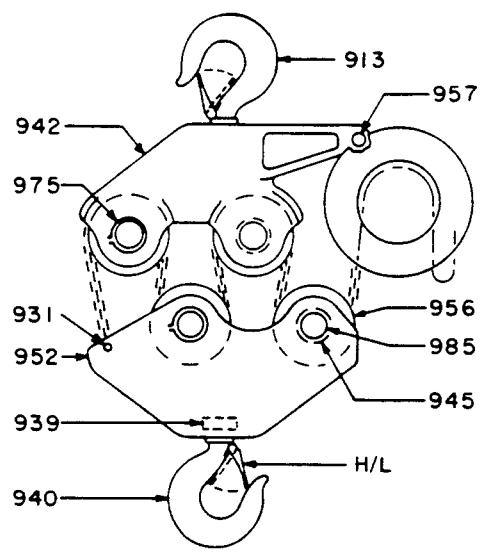

10 TON

N H Series



PART NO.	DESCRIPTION	QUANTITIES PER CAPACITY IN TONS													
		1/8"	1	1 1/2	2	3	4	5&6	8	10	12	16	20	25	
903	Bronze Bushing in Handwheel Cover	1	1	1	1	1	1	1	1	1	2	2	2	2	
905	Load Chain Guide	1	1	1	1	1	1	1	1	1	2	2	2	2	
906	Bronze Bushing for 959	1	1	1	1	1	1	1	1	1	2	2	2	2	
907	Ratchet Bushing for 935	1	1	1	1	1	1	1	1	1	2	2	2	2	
908	Pawl Snap Ring	1	1	1	1	1	1	1	1	1	2	2	2	2	
909	Cotter Pin	1	1	1	1	1	1	1	1	1	2	2	2	2	
910	Pawl Spring	1	1	1	1	1	1	1	1	1	2	2	2	2	
911	Bronze Bushing for 974	—	—	1	1	1	1	1	1	1	2	2	2	2	
912L	Large Separator Stud	—	—	1	1	1	1	1	1	1	1	1	1	1	
912S	Small Separator Stud	—	—	3	3	3	3	3	3	3	3	3	3	3	
913	Top Hook & Nut	1	1	1	1	1	1	1	1	1	1	1	1	1	
914	Hand Chain Guide	2	2	2	2	2	2	2	2	2	4	4	4	4	
916	Handwheel Treaded Insert	1	1	1	1	1	1	1	1	1	2	2	2	2	
918	Spindle	1	1	1	1	1	1	1	1	1	2	2	2	2	
919	Gear & Pinion Shaft	1	2	2	2	2	2	2	2	2	4	4	4	4	
920G	Internal Gear Frame	1	1	1	1	1	1	1	1	1	2	2	2	2	
920H	Handwheel Side Frame	1	1	1	1	1	1	1	1	1	2	2	2	2	
921	Pinion Cage	1	1	1	1	1	1	1	1	1	2	2	2	2	
922	Needle Bearings for Gear & Pinion	2	4	4	4	4	4	4	4	4	8	8	8	8	
923	Pawl	1	1	1	1	1	1	1	1	1	2	2	2	2	
925	Adjustable Check Ring	1	1	1	1	1	1	1	1	1	2	2	2	2	
927	Gear & Pinion	1	2	2	2	2	2	2	2	2	4	4	4	4	
928	Handwheel	1	1	1	1	1	1	1	1	1	2	2	2	2	
929	Load Sheave	1	1	1	1	1	1	1	1	1	2	2	2	2	
930	Gear Cover	1	1	1	1	1	1	1	1	1	2	2	2	2	
931	Drive Pin	1	1	1	1	—	—	1	—	1	—	—	—	—	
934	Brake Disc, Per/Pair	1	1	1	1	1	1	1	1	1	2	2	2	2	
935	Ratchet with 907 Bushing	1	1	1	1	1	1	1	1	1	2	2	2	2	
937	Hand Chain	1	1	1	1	1	1	1	1	1	2	2	2	2	
938	Load Chain	1	1	1	1	1	1	1	1	1	1	1	1	1	
939	Thrust Bearing	—	—	—	—	1	1	1	1	1	1	1	1	1	
940	Bottom Hook & Nut	—	—	—	—	1	1	1	1	1	1	1	1	1	
H/L	Hook Latch	2	2	2	2	2	2	2	2	2	2	2	2	2	
942	Top Hook Crosshead or Yoke	1	1	1	1	1	1	1	1	1	—	—	—	—	
942A	Top Yoke Block	—	—	—	—	—	—	—	—	—	1	1	1	1	
942B	Top Yoke Side Plate	—	—	—	—	—	—	—	—	—	2	2	2	2	
944	Top Sheave Pin	—	—	—	—	—	—	—	—	—	1	1	1	1	
945	Idler Sheave Bearing	—	—	—	—	1	1	2	3	4	5	7	9	11	
948	Bottom Hook Assembly	1	1	1	1	—	—	—	—	—	—	—	—	—	
950-2	Top or Bottom Chain Guide - 2 Grooves	—	—	—	—	—	—	—	—	—	1	2	3	1	
950-3	Top or Bottom Chain Guide - 3 Grooves	—	—	—	—	—	—	—	—	—	1	1	1	3	
951	Hoist Clevis	—	—	—	—	—	—	—	—	—	4	4	4	4	
952	Bottom Block or Crosshead	1	1	1	1	1	1	1	1	1	1	1	1	1	
953	Bottom Block Side Plates	—	—	—	—	—	—	—	—	—	2	2	2	2	
954	Bottom Sheave Pin	—	—	—	—	—	—	—	—	—	1	1	1	1	
956	Top or Bottom Idler Sheave	—	—	—	—	1	1	2	3	4	5	7	9	11	
957	Top Yoke Pin	—	—	—	—	1	1	1	1	1	2	2	2	2	
959	Pinion Cage Bearing Block	1	1	1	1	1	1	1	1	1	2	2	2	2	
960	Load Sheave Shaft Bearing	2	2	2	2	2	2	2	2	2	4	4	4	4	
961A	Top Idler Guide Pin	—	—	—	—	—	—	—	—	—	2	2	2	2	
961B	Bottom Idler Guide Pin	—	—	—	—	—	—	—	—	—	2	2	2	2	
962	Top or Bottom Idler Axle Keeper	—	—	—	—	—	—	—	—	—	2	2	2	2	
966	Load Sheave Shield	1	1	1	1	1	1	1	1	1	2	2	2	2	
967A	Top Yoke Contact Bar	—	—	—	—	—	—	—	—	—	1	1	1	1	
967B	Bottom Block Contact Bar	—	—	—	—	—	—	—	—	—	1	1	1	1	
968	Handwheel Cover with 903 Bushing	1	1	1	1	1	1	1	1	1	2	2	2	2	
969	Hoist Clevis Bolt & Nut	—	—	—	—	—	—	—	—	—	2	2	2	2	
971	Top or Bottom Guide Pin Snap Ring	—	—	—	—	—	—	—	—	—	8	8	8	8	
972	Bottom Crosshead (952) Snap Ring	—	—	—	—	—	—	—	—	—	2	2	2	2	
974	Load Shaft, Splined	1	1	1	1	1	1	1	1	1	2	2	2	2	
975	Snap Ring for 985 Sheave Axle	—	—	—	—	2	2	4	6	8	—	—	—	—	
985	Top or Bottom Sheave Axle	—	—	—	—	1	1	2	3	4	—	—	—	—	
988	SPECIAL FASTENERS (NOT SHOWN) Gear (930) & Handwheel (968) Cover Screw	8	8	8	8	8	8	8	8	8	16	16	16	16	
999	Hand Chain Guide (914) Screw	8	8	8	8	8	8	8	8	8	16	16	16	16	

PART PRICES ON REQUEST - CONTACT FACTORY.

CHAIN SPECIFICATIONS

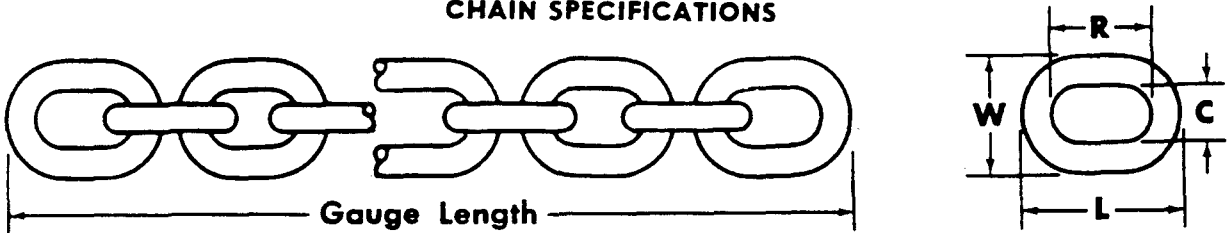

Use and Description	Chain Size	C	W	R	L	Gauge Length	Net Weight
HAND CHAIN							
All Capacities	1/4"	.347	.878	1.048	1.578	19 links: 20.562"	.60 lbs., ft.
LOAD CHAINS							
1/2 ton	9/32"	.313	.876	.794	1.357	25 links: 20.406"	.75 lbs., ft.
1 ton (Alloy)	9/32"	.313	.876	.794	1.357	25 links: 20.406"	.75 lbs., ft.
1 1/2, 2, 3, 4, 5, 6, 8, 10 thru 25 ton	3/8"	.466	1.216	1.147	1.897	13 links: 15.656"	1.23 lbs., ft.



N H Series

SERVICE INSTRUCTIONS AND MAINTENANCE MANUAL

OPERATING PRECAUTIONS

MAKE A COMPLETE INSPECTION of the hoist at regular and frequent intervals.

LUBRICATE AS RECOMMENDED, as often as may be necessary.

AVOID OVERLOADING and impacting. Use only with loads within the rated hoist capacity, and avoid sudden stops and jerking in raising or lowering. Both are dangerous and destructive, and will shorten the working life of the hoist.

LUBRICATING THE HOIST

Ordinarily only the load chain will require any periodic lubrication. Yale®NH hoists have been thoroughly lubricated and tested when they leave the factory. Normally, factory lubrication within the completely enclosed covers

will last throughout the working life of the hoist. However, the lubricant will melt and escape if the hoist is subjected to very high temperatures. Should this happen the lubrication must be renewed as recommended below.

(1) BRAKE

It should be immediately noted in connection with lubrication of the hoist that the brake requires none at any time. However, while it is preferable not to lubricate it, the brake will operate efficiently regardless of lubrication on its surfaces. It is advisable, though, to clean brake surfaces in the course of each inspection.

(2) BALL and NEEDLE BEARINGS

Lubricate with the best obtainable grade of sodium soap base grease recommended for anti-friction bearings, approximating A.S.T.M. working penetration 265-295.

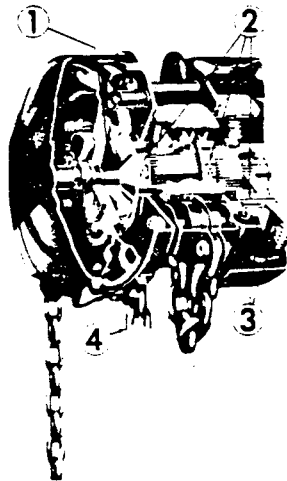

(3) GEARS

Use a high grade, non-corrosive lithium soap base grease with an extreme pressure additive. The mineral oil used in the manufacture of this grease should have a viscosity of 70 Saybolt Universal Seconds at 210° F, a pour point of 0° F, and a flash point of 400° F, minimum.

(4) LOAD CHAIN

Useful load chain life can be appreciably increased by immersing chain in oil at frequent intervals. Unlubricated chain wears rapidly from friction with the pocket wheel as well as with its own links. Bathe in oil as often as use may make necessary. Wipe off excess oil before using chain again.

Consult your local oil dealer in regard to recommended grades of lubrication.

CAUTION: Make needed replacements immediately.

If hooks are badly stretched or worn, replace with new ones.

Obviously worn or stretched chain should also be replaced immediately. Do not anneal Yale NH load chain. It has been heat treated and will not work-harden. It will wear well if kept well lubricated.

Replace the load sheave when both ends of each pocket be-

come excessively worn. If only one end of pockets shows wear, reverse the load sheave. If load sheave is replaced, do not use stretched or badly worn chain in new load sheave pockets.

Replace any badly worn or damaged brake assembly washers, pawl or pawl spring. Adjust check washer No. 925 if substantially greater than 1/4 inch throw is measured.

ASSEMBLY PROCEDURE

With seal sides facing out, assemble ball bearings No. 960 in internal gear frame No. 920-G and handwheel frame No. 920-H. Place load shaft No. 974 in internal gear frame bearing, with small splined end toward internal gear.

Assemble bearings No. 922 in gear-and-pinion No. 927. Assemble gear-and-pinion inside pinion cage No. 921 and place cotter in axles No. 919.



N H Series Assembly

Assemble bearing No. 906 in pinion cage bearing block No. 959, and press pinion cage bearing block into pinion cage. Assemble pinion cage complete with gears on splined load shaft. Line up the set-screw hole in pinion cage with hole in load shaft.

Now, time the gears. Locate punch marks on gears as shown in Fig. 2. These marks must be directly opposite each other as indicated, for proper timing.

FIG. 2

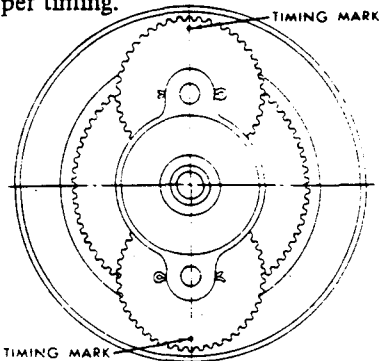

After gears are properly installed, press pinion cage with gears completely onto the load shaft, and secure with square-head setscrew and lock nut.

Assemble load sheave No. 929 on load shaft No. 974 with stripper No. 924 and load chain guide No. 905. Align stripper with studs on internal gear frame and press on as one assembly. Spacing of studs assures location.

Next, assemble pawl spring No. 910 and pawl No. 923 on handwheel frame stud and fasten with pawl retaining snap ring.

Assemble handwheel frame to internal gear frame, and install top hook No. 913 before pressing frame over separator studs. Fasten with four nuts and lock washers, making sure the tail of the pawl spring No. 910 is anchored under the nearest separator stud nut.

Run spindle No. 918 through load shaft. Spindle will fall in place and may be turned easily if gears are properly timed. If spindle cannot be turned, or locks, gears are out of time and the timing operation will have to be repeated.

Proceed with assembling the brake parts. Place one brake disc No. 934 over the threaded end of the spindle No. 918 and follow with the ratchet No. 935 and another brake disc No. 934. Fit the end of the pawl into the ratchet teeth.

Rotate handwheel and nut clockwise on spindle and tighten. Assemble check washer No. 925 on splined hub of part No. 916, making sure that lug on splined ring is $\frac{1}{4}$ inch minimum to right of hole in spindle. Insert drive cotter pin.

Try handwheel release, and if it releases hard, increase the gap between drive pin and check washer lug by one tooth. Keep the gap to a minimum. Handwheel nut No. 916 must not tighten against the drive pin when releasing.

Assemble bearing No. 903 in handwheel cover No. 968. Assemble hand chain No. 37 in handwheel cover.

Assemble handwheel cover to frame, and fasten with four round head screws and lock washers. Reeve the hand chain on handwheel with the welds up in the grooves. Apply and close open link.

Now, reeve load chain in load sheave, again with the side opposite the weld of each link riding in the groove. First and last links of chain must be in vertical position. Test reeving by pulling on hand chain. Excessive hand chain pull will indicate load chain is not properly set in load sheave pockets.

Remedy by backing load chain off and reeving again. Continued hand chain pulling will cause chain to ball, with serious damage to chain and cover.

Finally, fasten dead end of load chain to combination stripper and dead end support No. 924 with bolt nut and lock-washer.

Secure bottom shackles No. 933 to load chain and bottom hook No. 940, with hex head cap screw, castle nut, and cotter.

Lubricate gears as recommended on page 1, and assemble gear cover No. 930 on internal gear frame. Fasten with four round head screws and lock washers.

INSPECTION



INSPECTION RECORD

1. DATE _____ PERSON INSPECTING HOIST _____

COMMENTS _____

2. DATE _____ PERSON INSPECTING HOIST _____

COMMENTS _____

3. DATE _____ PERSON INSPECTING HOIST _____

COMMENTS _____

4. DATE _____ PERSON INSPECTING HOIST _____

COMMENTS _____

5. DATE _____ PERSON INSPECTING HOIST _____

COMMENTS _____

6. DATE _____ PERSON INSPECTING HOIST _____

COMMENTS _____

7. DATE _____ PERSON INSPECTING HOIST _____

COMMENTS _____

8. DATE _____ PERSON INSPECTING HOIST _____

COMMENTS _____

9. DATE _____ PERSON INSPECTING HOIST _____

COMMENTS _____

Yale®

HOISTS

WARRANTY

Every hoist is thoroughly inspected and tested prior to shipment from the factory. Should any problems develop, return the complete hoist prepaid to your nearest Yale Hoists Authorized Warranty Repair Station.

This warranty does not apply where: (1) deterioration is caused by normal wear, abuse, improper or inadequate power supply, eccentric or side loading, overloading, chemical or abrasive actions, improper maintenance or excessive heat; (2) problems resulted from repairs, modifications or

alterations made by persons other than factory or Yale Hoists personnel; (3) the hoist has been abused or damaged as a result of an accident; (4) repair parts or accessories other than those supplied by Yale Hoists are used on the hoist. Equipment and accessories not of the seller's manufacture are warranted only to the extent that they are warranted by the manufacturer. EXCEPT AS STATED HEREIN, YALE HOISTS MAKES NO OTHER WARRANTIES, EXPRESS OR IMPLIED, INCLUDING WARRANTIES OF MERCHANTABILITY AND FITNESS FOR A PARTICULAR PURPOSE.

Improvements:

Yale Hoists is constantly striving to improve its product. Changes in design and improvements will be made whenever manufacturer believes the efficiency of the product will be improved without incurring any obligation to incorporate such improvements in any products which have been shipped or are in service.

Important Notice:

Use of chain, wire rope or replacement parts other than as supplied as original equipment on Yale hoists may lead to dangerous operation. Accordingly, Yale Hoists cannot be responsible in such cases and our warranty will be voided.

For more information, write Yale Hoists, Forrest City, Arkansas 72335.

Yale® HOISTS
3105 N. Washington
P. O. Box 1000
Forrest City, Arkansas 72335
Customer Service (800) 999-6318
FAX (800) 766-0223