

IMPORTANT SAFETY INSTRUCTIONS

Please read this manual carefully and follow its instructions. Improper use or failure to follow these instructions could result in serious injury, death or property damage. Operators should be instructed in the safe and proper use and maintenance of this product. Keep this manual for future reference.

The following safety precautions call attention to potentially dangerous conditions.

! **DANGER:** Immediate hazards which **WILL** result in severe personal injury or death.

! **WARNING:** Hazards or unsafe practices which **COULD** result in severe personal injury or death.

! **CAUTION:** Hazards or unsafe practices which **MAY** result in *minor* personal injury or product or property damage.

NOTE: Instruct operators in the safe, proper use and maintenance. Keep this manual for future reference.

INSTALLATION

! **WARNING:** Failure to read, understand or follow these instructions could lead to hazards or unsafe practices **COULD** result in severe personal injury or death.

! **CAUTION:** Instruct operators in the safe, proper use and maintenance of this product. Hazards or unsafe practices **MAY** result in *minor* personal injury or product or property damage.

SWINGING MOUNTING

Hang retractor reel in desired location by clevis provided at top. Reel should be suspended directly over work area (see illustration), using an eyebolt or similar device with a break-strength exceeding 6 times the combined weight of reel and load it is supporting. Reel should be mounted in such a manner as to minimize cable contact with cable guide. For proper alignment, utilize three (3)-mounting holes at top of reel. If shackle is removed to make connections, be sure nut and cotter pin are properly replaced on shackle pin.

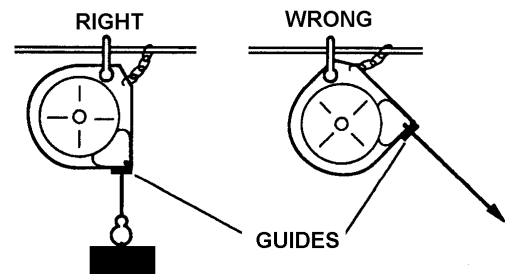

SECONDARY SUPPORT CHAIN

! **WARNING:** Attach a secondary safety cable, or chain, to all reels mounted overhead to prevent reel from falling. Immediate hazards **WILL** result in severe personal injury or death.

A hole has been provided at side of housing to permit installation of a secondary support chain. All reels mounted over head must have a secondary support chain to protect personnel in case of structure or mounting component failure. Attach one end of secondary support chain or cable to secondary support point (shackle) on reel. Attach other end of secondary support chain or cable to a support component other than that which supports the retractor reel. Chain or cable should be as short as possible allowing reel to drop no more than 6 to 12 inches if the primary connection is released. (See Illustration above). A secondary support is offered as an accessory item.

OPERATION

TOOL ATTACHMENT

WARNING: Never pull cable to device to be retracted. Always lift object to hook. If the hook is accidentally released when it is extended, it will snap back. Hazards or unsafe practices which COULD result in severe personal injury or death.

Retractor reel is furnished with a tool clip. Attach tool complete with hose or cable and fittings. If, after installation, it is determined the cable overhang is not sufficient; an overhang extension cable can be used to extend overhang without reducing active travel. This is available as an optional item. To adjust length of overhang, remove all tension, then pull down and position hook at desired height. Loosen cable stop, then slide cable stop upward to roller guide and tighten. Move cable stop upward and lengthen overhang of cable to reduce active travel distance. For every foot more of overhang adjusted on retractor cable, there is an equal reduction in cable travel.

SPRING TENSIONING

WARNING: Attach full load including all attachments before adjusting tension. Hazards or unsafe practices COULD result in severe personal injury or death.

CAUTION: When releasing tension, always do so slowly, and with wrench held firmly on shaft flats. Gloves should be worn when using tension release lever. Hazards or unsafe practices which MAY result in *minor* personal injury or product or property damage.

Tool including all attachments and connections must be in place before adjusting spring tension.

- If load exceeds spring tension, tool will drop, and tension must be increased.
- If tool is fully retracted but spring tension, seems excessive (rapid retraction), decrease tension.

Tension should always be enough to retract tool and to keep cable stop against guide.

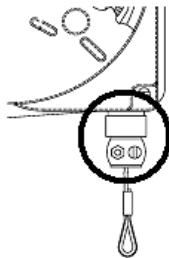

To Increase Tension

Engage a wrench on flats on mainspring shaft and turn in "+" direction (as shown in diagram).

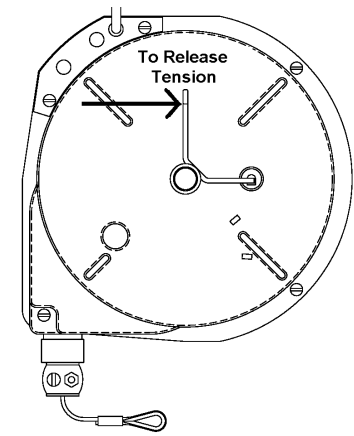
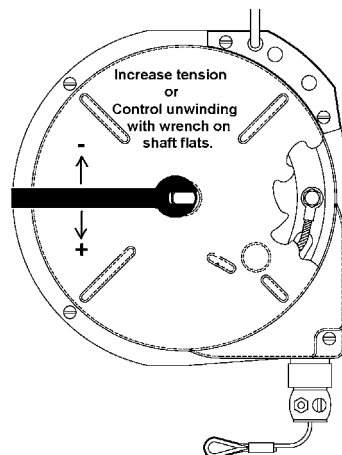

To Decrease Tension

Engage a wrench on flats on mainspring shaft. As tension release lever on opposite side of retractor is gently pushed, shaft will unwind. Control unwinding with firmly held wrench.

After adjusting tension, pull cable to fullest extension to ensure full cable travel. If cable does not reach full extension, some tension must be released. If proper tension and extension cannot be achieved, another unit may be required. Please consult factory.

RATCHET LOCK (FOR 10FLR & 15FLR ONLY)

The ratchet lock can engage about every 9" of cable travel. Pull cable to desired location and let cable retract slightly until lock engages. If it doesn't engage, pull out a further, and then allow to retract. To release lock, pull cable out at least 6". For constant tension, ratchet lock may be disengaged. Turn lock release knob counter-clock wise while pulling cable in and out slightly to engage lock release lever.

CABLE STOP ADJUSTMENT

NOTE: Moving the cable stop will reduce the active travel distance. If additional cable extension is required, extension cable assemblies are offered as an accessory.

Cable stop can be moved up along the cable to attain the most desirable working height.

SERVICE

MAIN SPRING REPLACEMENT

 **CAUTION:** Remove all tension before removing mainspring. Hazards or unsafe practices MAY result in *minor* personal injury or product or property damage.

 **WARNING:** Spring is dangerous. Always wear gloves. Before removing broken spring, weld coils together at four (4) locations or wrap securely with wire. Hazards or unsafe practices COULD result in severe personal injury or death.

Remove **All** tension from main spring (See Spring Tension Adjustment). Remove cotter pin and then clevis. Next, remove the retaining ring and the three (3) screws, also plates and screws. Remove housing. Remove drum-cover nuts and cover. Carefully remove mainspring from drum. Hub may come off shaft with spring.

If so, replace hub into new spring while making sure hub engages spring coils. Replace spring in drum while making sure the spring hook engages with drum outer hook. To reassemble, reverse the above procedure. Be sure the hub engages the pin on the main shaft when reassembling.

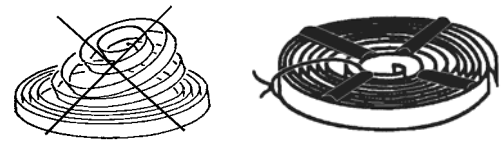

CABLE REPLACEMENT

Whenever a cable shows signs of deterioration, it should be replaced with a new cable. Remove **All** tension from main spring (See Spring Tension Adjustment). Remove clevis by removing the cotter pin. Next, remove the retaining ring and the three (3) screws, also plates and screws. Remove housing. Remove nut and cable. Replace with new cable while threading it through guide first when reassembling.

RATCHET LOCK REPLACEMENT

Remove **All** tension from main spring (See Spring Tension Adjustment). Remove clevis by removing the cotter pin. Next, remove the retaining ring and the three (3) screws, also plates and screws. Remove retaining ring, washer, and spring lock, and retaining ring. The housing can now be removed. Remove retaining ring and unclip spring, then remove ratchet lock. To reassemble, reverse the above procedure.

PARTS REPLACEMENT

 **CAUTION:** Always remove all spring tension (see “Spring Tension Adjustment”) before attempting to disassemble internal parts. Always remove retractor reel from service. Hazards or unsafe practices MAY result in *minor* personal injury or product or property damage.

NOTE: When ordering replacement parts, always include retractor reel model number and serial number.

All parts are replaceable in the field without special tools.

LUBRICATION

All bearings, springs, etc. are permanently lubricated at factory and should require no further lubrication.

MAINTENANCE & INSPECTION

Due to the design, this reel will require little maintenance other than a periodic check of the cable, safety chain, and hanger for wear. All worn parts or cable should be removed from service and/or replaced at once.

REPLACEMENT PARTS

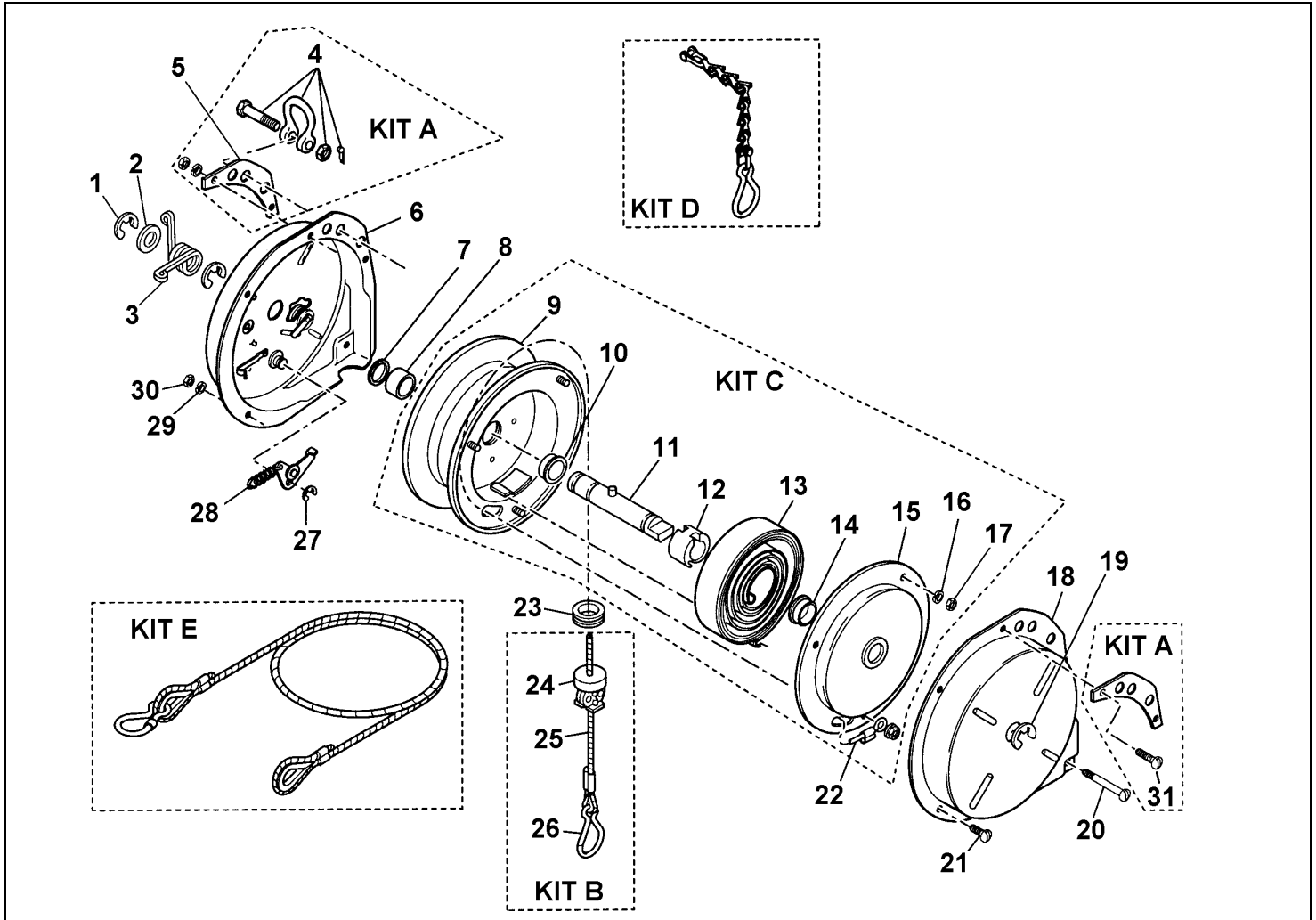

Reference Number	Part Number	Qty.	Description
1	00580P0045	2	Ring; Retaining (.625)
2	0981300000	1	Washer
3 *	0961600000	1	Lock; spring Tension
4	01240P0010	1	Assembly; Clevis (included in Kit A)
5	M62710002	2	Plate; Hanger Mounting (included in Kit A)
6	0988600000	1	Assembly; Housing (10 & 15FLR with 27, 28, & 33 ratchet parts)
	0968100001	1	Housing: Standard (10F & 15F)
7	1409900000	AR	Spacer (used for shim only)
8	0961100000	1	Spacer
9	0967900000	1	Assembly; Cable Drum (10F & 15F)(included in Kit C)
	0967200000	1	Assembly; Cable Drum (10 & 15FLR) included in Kit C)
10	1361000002	1	Bearing; Main Shaft (included in Kit C)
11	0967300000	1	Shaft; Main (included in Kit C)
12	1405800002	1	Hub: Spring (included in Kit C)
13 *	0961800203	1	Spring (10F & 10FLR)(included in Kit C)
	0961800245	1	Spring (15F & 15FLR)(included in Kit C)
14	1361000001	1	Bearing; Main Shaft (included in Kit C)
15	0967100000	1	Cover (included in Kit C)
16	00103P0035	2	Washer; Lock (#8, internal tooth) (included in Kit C)
17	00151P0085	2	Nut; (#8 - 32) (included in Kit C)
18	0962100000	1	Housing

19	C01700131	1	Ring; Retaining
20	00002P0114	1	Screw; (#8 - 32 x 1 3/4)
21	00002P0101	2	Screw; (#8 - 32 x 5/16)
22	00160P0078	1	Nut; Lock (#8 - 32) (included in Kit C)
23	1361300000	1	Guide; Cable
24	0983300000	1	Adjustable Cable Stop (included in Kit B)
25 *	0963900008	1	Cable (8 ft.) (included in Kit B)
26	01146P0015	1	Hook (included in Kit B)
27	00580P0030	1	Ring; (.375) Retaining
28	H05040010	1	Kit; Springs & Lever (see item 33)
29	00103P0035	5	Washer; Lock (#8 internal tooth)
30	00151P0085	5	Nut (#8 - 32)
31	00002P0105	2	Screw (#8 – 32 x 5/8) (included in Kit A)
32	1003100000	1	Bumper; Rubber
33	0962200000	1	Ratchet lever (without spring)
OPTIONAL KITS			
Kit A	H16510007	AR	Clevis Kit (includes items 4, 5, 31)
Kit B	0967800008	AR	Assembly; Cable (includes items 24, 25, 26, 32)
	H13150008		Assembly; Cable Nylon Coated, (includes items 24, 25, 26, 32)
Kit C	0969900203	AR	Assembly; Mainspring, Drum & Shaft (10F; includes items 9-17 &22)
	0969900245		Assembly; Mainspring, Drum & Shaft (15F; includes items 9-17 &22)
	0988700203		Assembly; Mainspring, Drum & Shaft (10FLR; includes items 9-17 &22)
	0988700245		Assembly; Mainspring, Drum & Shaft (15FLR; includes items 9-17 &22)
Kit D	4963800000	AR	Chain; Safety
Kit E	4965000009	AR	Cable Overhang (2 ft.)
	4965000001		Cable Overhang (3 ft.)
	4965000002		Cable Overhang (5 ft.)
	4965000003		Cable Overhang (10 ft.)
	4965000004		Cable Overhang (15 ft.)
	4965000005		Cable Overhang (20 ft.)
	4965000006		Cable Overhang (25 ft.)
	4965000007		Cable Overhang (30 ft.)
	4965000008	Cable Overhang (35 ft.)	
* Recommended Spare Parts			