



Model 5557

8" Geared Dual Action Sander

Form # Z544
Date 4-99/A



IMPORTANT

Read these instructions carefully before installing, operating, servicing or repairing this tool. Keep these instructions in a safe accessible place.

SAFETY MESSAGES		WARNING	Operator Instructions
Personal Safety Equipment		Always Read Instructions Before Using Power Tools	Includes: Safety Rules Foreseen Use Work Stations Putting Into Service Operating Dismantling and Assembly.
Use – Safety Glasses	YES	Always Wear Safety Goggles	
Use – Safety Gloves		Wear Hearing Protection	
Use – Safety Boots		Avoid Prolonged Exposure To Vibration	
Use – Breathing Masks			
Use – Ear Protectors	YES		

Safety rules when using a 5557 Sander

- Do not use as a grinder.
- Do not use polystyrene pads.
- Use accessories rated above 850 RPM.
- Prolonged exposure to vibration may cause injury.
- Read all instructions before using this tool. All operators must be fully trained in its use and aware of these safety rules.
- Do not exceed the maximum working air pressure.
- Use personal protection equipment as recommended.
- Use compressed air only at the recommended conditions.
- If the tool appears to malfunction, remove from use immediately and arrange for service and repair. If it is not practical to remove tool from service, then shut off the air supply to the tool and write or have written a warning note and attach it to the tool.
- If tool is to be used with a balancer or other suspension device, ensure that the tool is firmly attached to the suspension/support device.
- When operating the tool, always keep the body and particularly the hands away from the working attachment fixed to the tool.
- The tool is not electrically insulated. Never use the tool if there is any chance of coming into contact with live electricity.
- Always when using the tool, adopt a firm footing and/or position and grip the tool sufficiently only to overcome any reaction forces that may result from the tool doing work. Do not overgrip.
- Use only correct spare parts for maintenance and repair. Do not improvise or make temporary repairs. Major servicing and repairs should only be carried out by persons trained to do so.
- Do not lock, tape, wire, etc. the 'On/Off' valve in 'On' position. The throttle trigger/lever, etc. must always be free to return to the 'Off' position when released.
- Always shut off the air supply to the tool and press the 'On/Off' valve to exhaust the air from the feed hose before fitting, removing or adjusting the working attachment fitted to the tool.
- Before using the tool, make sure that a shut off device has been fitted to the supply line and the position is known

- and easily accessible so that the air supply to the tool can be shut off in an emergency.
- Check hose and fittings regularly for wear.
- Take care against entanglement of the moving parts of the tool with clothing, hair, ties, cleaning rags, rings, jewelry, watches, bracelets, etc. This could cause the body or parts of the body to be drawn towards and in contact with the moving parts of the tool and could be very dangerous.
- It is expected that users will adopt safe working practices and observe all local, regional or country legal requirements when installing, using or maintaining the tool.
- Take care that the exhaust air does not point towards any other person or material or substance that could be contaminated by oil droplets. When first lubricating a tool or if the tool exhaust has a high oil content, do not allow the exhaust air to come near very hot surfaces or flames.
- Never lay the tool down until the working attachment has stopped moving.
- When the tool is not in use, shut off the air supply and press throttle trigger/lever to drain the supply line. If the tool is not to be used for a period of time, first lubricate, disconnect from air supply and store in a dry average room temperature environment.
- If the tool is passed from one user to a new or inexperienced user, make sure these instructions are available to be passed with the tool.
- Do not remove any manufacturer fitted safety devices where fitted, i.e., wheel guards, safety trigger, speed governors, etc.

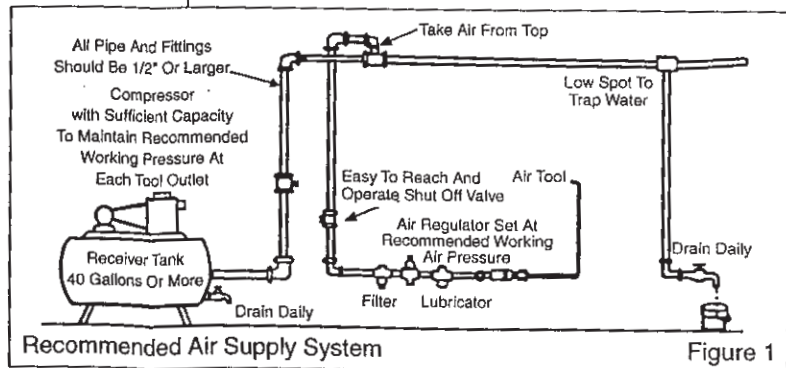

- Wherever possible, secure workpiece with clamps, a vise, etc. to make it rigid so it does not move during the work operation. Keep good balance at all times. Do not stretch or overreach.
 - Try to match the tool to the work operation. Do not use a tool that is too light or heavy for the work operation. If in doubt, seek advice.
 - In general terms, this tool is not suitable for underwater use or use in explosive environments — seek advice from manufacturer.
- Try to make sure that the work area is clear to enable the work task to be performed safely. If practical and possible, try to clear unnecessary obstructions before starting work.
 - Always use air hose and couplings with minimum working pressure ratings at least 1 1/2 times the maximum working pressure rating of the tool.

Foreseen Use Of The Tool – 5557

The tool is designed for the purpose of cleaning or sanding of a variety of materials typically metal, wood, plastic materials, etc. The dual rotary orbital action reduces the amount of abrasive grinding marks and hence is primarily a finishing sanding tool. It can be used with a variety of grades of 8" diameter (203 mm) abrasive discs which, according to pad fitted to the tool, can be self adhesive. Do not use the tool for any other purpose than that for which it was designed and use only abrasive discs as described. Do not modify the tool for any other use or for its use as a sander without first consulting the manufacturer or his authorized representative.

Work Stations

The tool should only be used as a handheld, hand operated tool. It is always recommended that the tool is used when standing on a solid floor. It can be used in other positions, but before any such use, the operator must be in a secure position having a firm grip and footing and be aware of the safety rules to be obeyed when using the sander.

Putting Into Service

Air Supply

Use a clean lubricated air supply that will give a measured air pressure at the tool of 60 PSIG (4.2 bar) when the tool is running with the trigger/lever fully depressed. Use recommended hose size and length. It is recommended that the tool is connected to the air supply as shown in figure 1. Do not connect the tool to the air line system without incorporating an easy to reach and operate air shut off valve. The air supply should be lubricated. It is strongly recommended that an air filter, regulator, lubricator (FRL) is used as shown in Figure 1 as this will supply clean, lubricated air at the correct pressure to the tool. Details of such equipment can be obtained from your supplier. If such equipment is not used, then the tool should be lubricated by shutting off the air supply to the tool, depressurizing the line by pressing the trigger on the tool. Disconnect the air line and pour into the hose adaptor a teaspoonful (5ml) of a suitable pneumatic motor lubricating oil preferably incorporating a rust inhibitor. Reconnect tool to air supply and run tool slowly for a few seconds to allow air to circulate the oil. If tool is used frequently, lubricate on daily basis and if tool starts to slow or lose power. It is recommended that the air pressure at the tool while the tool is running is 60 PSI/4.2 bar.

Operating

Select a suitable abrasive disc (see Section "Foreseen Use Of The Tool") and make sure that it is fixed securely to the tool. Connect to suitable air supply as recommended.

Apply the sander lightly to the work and allow the abrasive disc to cut. Take great care when sanding around sharp edges and surfaces to avoid the disc snagging i.e. the disc may be brought to an abrupt stop or considerably slowed which will cause the tool to kick in the hands. It is always recommended to use safety glasses and a breathing mask. The sanding of certain materials may create a hazardous dust which may require special breathing equipment. Check before using the tool. Even if the machine has a low noise level, the actual sanding process may cause a noise level such that ear protectors will be required. If there are sharp areas on the material being sanded, safety gloves are recommended.

Do not continue to use abrasive discs that are worn or clogged. This will make the sanding process inefficient and the need to apply unnecessarily high forces to the tool.

Do not use undersized or oversized discs. The disc should be no more than 1/4" larger in diameter than the pad and not smaller than the pad. An air regulator switch (42) is located on the side of the motor housing (14). It can be used to vary the volume of compressed air fed to the motor which will vary the speed of the sander.

Dismantling & Assembly Instructions

Disconnect tool from air supply.

Unscrew five screws (1) and then remove 8" pad (2). Unscrew screw (5) and remove balance shaft (4) with pin (3), screw (6), balance nut (7) and balance washer (8). Unscrew screw (6) and then remove balance nut (7). Pull out aluminum gear cover (9) with bearing (10), screws (11 & 13) and internal gear (12). Unscrew screws (13) and then pull out internal gear (12) from aluminum gear cover (9). Unscrew three screws (11), then tap bearing (10) through aluminum gear cover (9).

Remove two screws (39) and take off plastic cover (49) with muffler element (48) and muffler (47). Unscrew screw (15) and then grip motor housing (14) in a vise fitted with soft jaws. Remove four retaining screws and take off motor cover (31). From the front end of the tool, tap the end of the rotor shaft (20) to drive the motor assembly out of the motor housing (14). Note how the slot in the side of the cylinder (28) has to line up with the port in the motor housing (14). Pull off front end plate (30) with bearing (26) and washer (27). Remove shim (22), pin (29), cylinder (28) and rotor blades (25). Unscrew screw (24) from rotor (23) and remove rotor shaft (20) with rear end plate (19). Note location of screw (24) hole in rotor (23) in position with flat on rotor shaft (20) and remove shims (22). Tap front end of rotor shaft (20) through rear end plate (19) to remove bearing (21) from rear end plate (19). Grip gear (16) in a vise fitted with soft jaws and then unscrew screws (17) to tap rear end plate (19) through gear (16).

Unscrew cap screw (33) and take out spring (34), valve pin (45) and O-ring (35). Do not remove the valve bushing (46) from motor housing (14). Take off retaining ring (36) to remove flat washer (38) and washer (36). Unscrew screw (44) and remove regulator nut (42), then carefully pull out regulator (40) with two O-rings (35). Unscrew screw (53) from nut (54) and take off lever (52). Take out two screws (50) and remove lever bracket (51). Remove handle grip (57) and unscrew handle (58) from motor housing (14) and take off lever bracket (55). Remove muffler (47) and muffler element (48) from plastic cover (49).



5557
8" Gear Driven
Orbital Sander

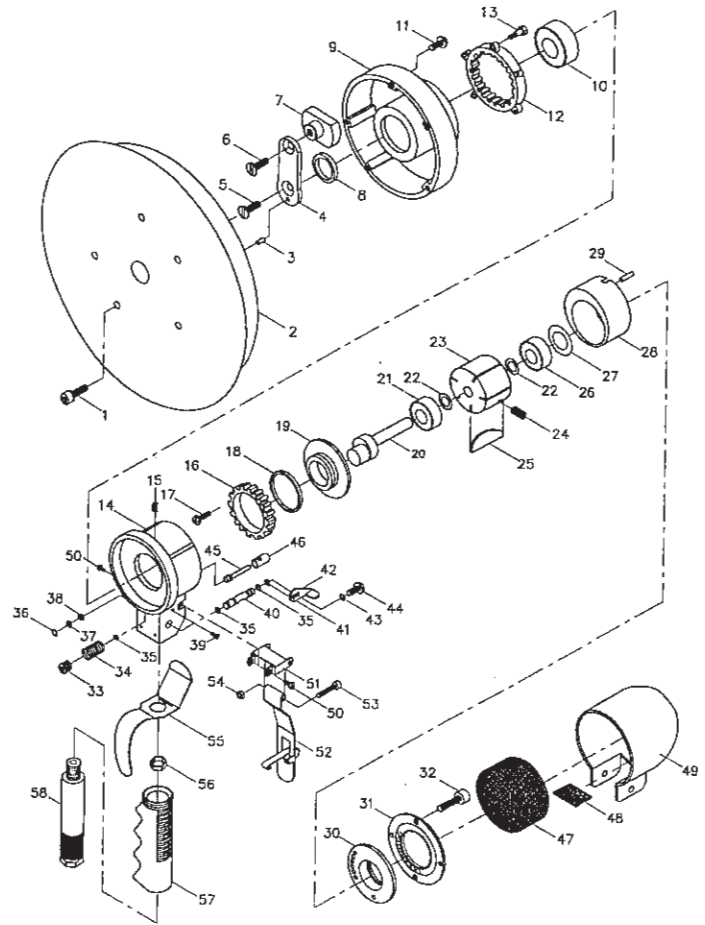

Ref. No.	Part No.	Description
1	505769	Screw (5)*
2	505770	8" Pad
3	505771	Pin
4	505772	Balance Shaft
5	505773	Screw
6	505774	Screw
7	505775	Balance Nut
8	505776	Balance Washer
9	505777	Aluminum Gear Cover
10	505778	Ball Bearing
11	505779	Screw (3)*
12	505780	Internal Gear
13	505781	Screw (5)*
14	505782	Motor Housing
15	505783	Screw
16	505784	Gear
17	505785	Screw (3)*
18	505786	O-Ring
19	505787	Rear End Plate
20	505788	Rotor Shaft
21	505035	Ball Bearing
22	67275	Shlm (2)*
23	505789	Rotor
24	505790	Screw
25	67278	Rotor Blade (Set of 5)
26	67279	Ball Bearing
27	67280	Washer
28	505791	Cylinder
29	67282	Pin
30	67283	Front End Plate

Ref. No.	Part No.	Description
31	67284	Motor Cover
32	67285	Motor Screw (4)*
33	67286	Screw
34	505792	Spring
35	67288	O-Ring (3)*
36	67289	Retaining Ring
37	505793	Washer
38	67291	Rubber Washer
39	67292	Cover Screw
40	67294	Oil Seal
41	505046	O-Ring
42	67296	Regulator Switch
43	67297	Washer
44	67298	Screw
45	67299	Push Rod
46	505794	Valve Bushing
47	67301	Muffler
48	67302	Muffler Element
49	505795	Plastic Cover
50	67304	Screw
51	67305	Bracket
52	505796	Safety Lever
53	67306	Screw
54	67307	Nut
55	505800	Valve Lever
56	67309	Nut
57	505797	Rubber Grip
58	505798	Steel Handle
Not Shown	505799	Name Plate

*Order Quantity as Needed







Reassembly

Clean all parts, examine for wear. Use only manufacturer or authorized distributor supplied parts and replace any worn parts. Look in particular for wear on seals, ball bearings and blades. Coat all parts with a suitable pneumatic tool lubricating oil, one preferably containing a rust inhibitor, and reassemble in the reverse order carefully. With lever depressed, pour 5 ml of a suitable pneumatic tool lubricating oil into inlet bushing and release. Connect the tool to a suitable air supply and operate the tool slowly for 2 or 3 seconds to allow the oil to circulate.

Operation Specification	
Air Consumption	5.0 cfm (36 scfm)
Height	4.7" (120 mm)
Spindle Thread	5/16"-18UNF
Overall Length	11.0" (280 mm)
Air Inlet Thread	1/4-18NPT
Pad Size	8" (203 mm)
at 60 PSIG (4.2 bar)	

NOTES

NOTES

Manufacturer/Supplier Sioux Tools Inc. 2901 Floyd Boulevard P.O. Box 507 Sioux City, IA 51102 U.S.A. Tel No. 712-252-0525 Fax No. 712-252-4267		Product Type 8" Geared Dual Action Sander	RPM 850 Cycles Per Min.	
		Model No/Nos 5557	Serial No.	
Product Net Weight 4.80 lbs 2.18 Kg	Recommended Use Of Balancer Or Support N0	Recommended Hose Bore Size -- Minimum 5/16 Ins 8 M/M	Recommended Max. Hose Length 30 Ft 10 M	
Air Pressure Recommended Working 4.2 bar 60 PSI Maximum 4.2 bar 60 PSI		Noise Level: Sound Pressure Level 87.0 dB(A) Test Method: Tested in accordance with Pneurop test code PN8NTC1 and ISO Standard 3744		
SAFETY MESSAGES Personal Safety Equipment Use - Safety Glasses YES Use - Safety Gloves Use - Safety Boots Use - Breathing Masks Use - Ear Protectors YES	 WARNING  Always Read Instructions Before Using Power Tools  Always Wear Safety Goggles  Wear Hearing Protection  Avoid Prolonged Exposure To Vibration	Vibration Level 3.7 Meters / Sec² Test Method: Tested in accordance with ISO standards 8662 Parts 1 & 8 Tested at 60 PSIG Air Pressure		

Declaration of Conformity

Sioux Tools Inc.

2901 Floyd Boulevard, P.O. Box 507, Sioux City, Iowa 51102

declare under our sole responsibility that the product

Model 5557 8" Geared Dual Action Sander, Serial Number

to which this declaration relates is in conformity with the following standard(s) or other normative document(s)

EN792 (Draft), EN292 Parts 1 & 2, ISO 8662 Parts 1 & 8, Pneurop PN8NTC1

following the provisions of **89/392/EEC as amended by 91/368/EEC & 93/44/EEC Directives**

Gerald E. Seebeck (President)

Name and signature or equivalent marking of authorized person