

Operating Instructions

Variable Speed
Cordless
Impact Driver
Model: EY6588

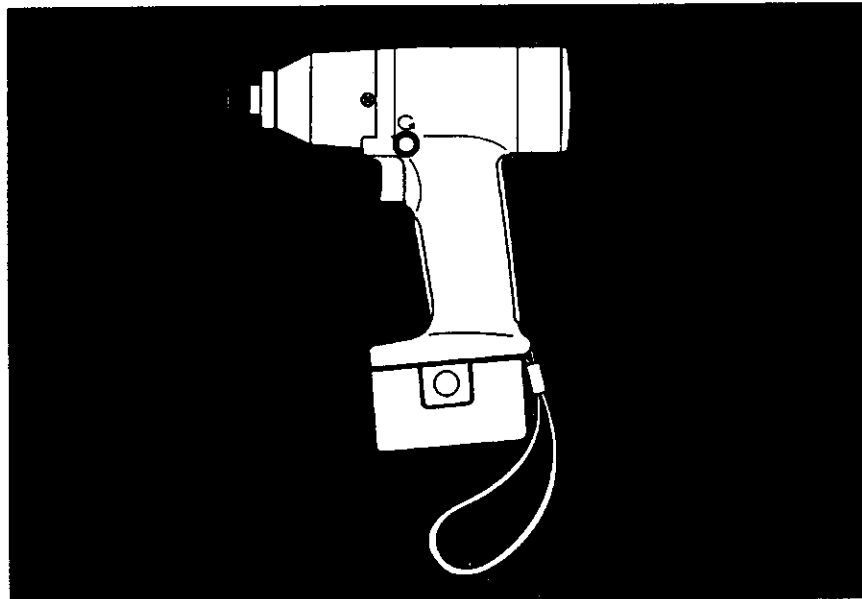

Panasonic ✱

Before operating this unit, please read these instructions completely.

IMPORTANT SAFETY INSTRUCTIONS

WARNING: When using electric tools, basic safety precautions should always be followed to reduce the risk of fire, electric shock and personal injury, including the following:

READ ALL INSTRUCTIONS BEFORE USING

- 1) **KEEP WORK AREA CLEAN.** Cluttered areas and benches invite accidents.
- 2) **CONSIDER WORK AREA ENVIRONMENT.** Do not expose power tools to rain. Do not use power tools in damp or wet locations. Keep work area well lit. Do not use tool in presence of flammable liquids or gases.
- 3) **GUARD AGAINST ELECTRIC SHOCK.** Prevent body contact with grounded surfaces. For example; pipes, radiators, ranges, refrigerator enclosures.
- 4) **KEEP CHILDREN AWAY.** Do not let visitors contact tool. All visitors should be kept away from work area.
- 5) **STORE IDLE TOOLS.** When not in use, tools should be stored in a dry, high or locked-up place - out of reach of children.
- 6) **DON'T FORCE TOOL.** It will do the job better and safer at the rate for which it was designed.
- 7) **USE RIGHT TOOL.** Don't force small tools or attachments to do the job of a heavy duty tool. Don't use tool for purpose not intended—for example—don't use circular saw for cutting tree limbs or logs.
- 8) **WEAR PROPER APPAREL.** No loose clothing or jewelry to get caught in moving parts. Rubber gloves and nonskid footwear are recommended when working outdoors. Wear protective hair covering to contain long hair.
- 9) **USE SAFETY GLASSES** with most tools. Also use face or dust mask in dusty environment.
- 10) **SECURE WORK.** Use clamps or a vise to hold work. It's safer than using your hand and it frees both hands to operate tool.
- 11) **DON'T OVERREACH.** Keep proper footing and balance at all times.
- 12) **MAINTAIN TOOLS WITH CARE.** Keep tools sharp at all times and clean for best and safest performance. Follow instructions for lubricating and changing accessories. Keep handles dry, clean, and free from oil and grease.
- 13) **DISCONNECT TOOLS/BATTERIES.** When not in use, before servicing, and when changing accessories, such as bits.
- 14) **REMOVE ADJUSTING KEYS AND WRENCHES.** Form a habit of checking to see that keys and adjusting wrenches are removed from tool before turning it on.
- 15) **AVOID ACCIDENTAL STARTING.** Don't carry tool with finger on switch.
- 16) **STAY ALERT.** Watch what you are doing. Use common sense. Do not operate tool when you are tired.
- 17) **CHECK DAMAGED PARTS.** Before further use of the tools, check guard or other safety devices carefully to determine that they will operate properly and perform their intended function. Check for alignment of moving parts, binding of moving parts, breakage of parts, mounting, and any other conditions that may affect its operation. A guard or other part that is damaged should be properly repaired or replaced by an authorized service center. Have defective parts replaced by an authorized service center. Do not use a defective tool.

SAVE THESE INSTRUCTIONS

FOR BATTERY CHARGER & BATTERY PACK

1) SAVE THESE INSTRUCTIONS

- This manual contains important safety and operating instructions for battery chargers EY0202.

- 2) Before using battery charger, read all instructions and cautionary markings on (1) battery charger, (2) battery pack.
- 3) **CAUTION** - To reduce the risk of injury, charge only battery pack as shown below.

RE570	EY970, EY9080, EY9086	Approx. 1 hour
EY0001	EY9001, EY9006	Approx. 1 hour
EY0202	EY9001, EY9080, EY9065 EY9006, EY9086	Approx. 15 min.
	EY9101, EY9180, EY9182	Approx. 20 min.

Other types of batteries may burst causing personal injury and damage.

- 4) Do not expose charger to rain or snow.
- 5) To reduce risk of damaging the electric plug and cord, pull by plug rather than cord when disconnecting charger.
- 6) Make sure cord is located so that it will not be stepped on, tripped over, or otherwise subjected to damage or stress.
- 7) An extension cord should not be used unless absolutely necessary.

Use of improper extension cord could result in a risk of fire and electric shock. If extension cord must be used, make sure:

- a. that pins on plug of extension cord are the same number, size and shape as those of plug on charger.
- b. that extension cord is properly wired and in good electrical condition.

- c. that wire size is large enough for ampere rating of charger as specified below.

RECOMMENDED MINIMUM AWG SIZE OF EXTENSION CORDS FOR BATTERY CHARGERS					
AC Input Rating.	Amperes	AWG Size of Cord			
		Length of Cord, Feet			
Equal to or greater than	But less than	25	50	100	150
0	2	18	18	18	18

- 8) Do not operate charger with damaged cord or plug – replace them immediately.
- 9) Do not operate charger if it has received a sharp blow, been dropped, or otherwise damaged in any way; take it to a qualified serviceman.
- 10) Do not disassemble charger; take it to a qualified serviceman when service or repair is required. Incorrect reassembly may result in a risk of electric shock or fire.
- 11) To reduce the risk of electric shock, unplug charger from outlet before attempting any maintenance or cleaning.
- 12) The charger and battery pack are specifically designed to work together. Do not attempt to charge any other cordless tool or battery pack with this charger.
- 13) Do not attempt to charge the battery pack with any other charger.
- 14) Do not attempt to disassemble the battery pack housing.
- 15) Do not store the tool and battery pack in locations where the temperature may reach or exceed 122°F (50°C) (such as a metal tool shed, or a car in the summer), which can lead to deterioration of the storage battery.

- 16) Do not charge battery pack when the temperature is **BELOW 32°F (0°C)** or **ABOVE 104°F (40°C)**. This is very important.
 - 17) Do not incinerate the battery pack. It can explode in a fire.
 - 18) Avoid dangerous environment. Do not use charger in damp or wet locations.
 - 19) The charger is designed to operate on standard household electrical power only. Do not attempt to use it on any other voltage!
 - 20) Do not abuse cord. Never carry charger by cord or yank it to disconnect from outlet. Keep cord away from heat, oil and sharp edges.
 - 21) Charge the battery pack in a well ventilated place, do not cover the charger and battery pack with a cloth, etc., while charging.
 - 22) Use of an attachment not recommended may result in a risk of fire, electric shock, or injury to persons.
 - 23) Do not short the battery pack. A battery short can cause a large current flow, over heating and burns.
 - 24) **NOTE:** If the supply cord of this appliance is damaged, it must only be replaced by a repair shop appointed by the manufacturer, because special purpose tools are required.
- 3) If the bit becomes jammed, immediately turn the main switch off to prevent an overload which can damage the battery pack or motor. Use reverse motion to loosen jammed bits.
 - 4) Do not operate the reversing lever when the main switch is on. The battery will discharge rapidly and damage to the unit may occur.
 - 5) During charging, the charger may become slightly warm. This is normal. Do not charge the battery for a long period.
 - 6) Use only a dry, soft cloth for wiping the unit. Do not use a damp cloth, thinner, benzene, or other volatile solvents for cleaning.
 - 7) When storing or carrying the tool, set the reversing lever to the center (switch lock) position.
 - 8) Do not strain the tool by holding the speed control trigger halfway (speed control mode) so that the motor stops.
 - 9) Do not operate the speed selector switch (LOW-HIGH) while pulling on the speed control trigger. This can cause the rechargeable battery to wear quickly or damage the internal mechanism of the motor.

ADDITIONAL SAFETY RULES

- 1) Be aware that this tool is always in an operating condition, since it does not have to be plugged into an electrical outlet.
- 2) When drilling or driving into walls, floors, etc., "live" electrical wires may be encountered. **DO NOT TOUCH THE CHUCK OR ANY FRONT METAL PARTS OF THE TOOL!** Hold the tool only by the plastic handle to prevent electric shock in case you drill or drive into a "live" wire.

• Changes or modifications not expressly approved by MATSUSHITA ELECTRIC WORKS, LTD. could void the user's authority to operate the equipment.

Main Unit

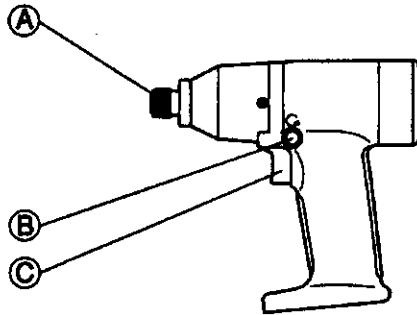

EY6588

Battery Pack

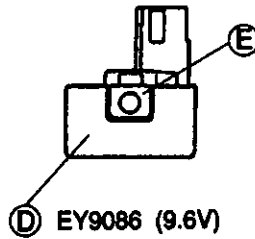

EY9086 (9.6V)

Battery Charger

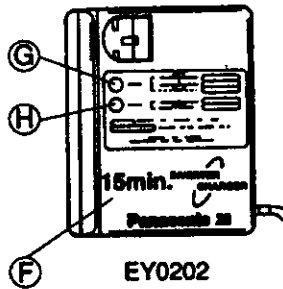

EY0202

PART IDENTIFICATION

Ⓐ Bit holder

Attaching the bits

Note: When attaching or removing bits, be sure to set the reversing lever to the center (switch lock) position.

1. Hold the bit holder and pull it against the driver.
2. Insert the bit into the hole of the drive shaft.
3. The bit holder will return to its original position when released.
4. Pull the bit to make sure it does not come out.
5. To remove the bit, pull back on the bit holder in the same way.

CAUTION:

If the bit holder does not return to its original position or the bit comes out when pulled on, the bit has not been properly attached. Make sure the bit is properly attached before use.

Ⓑ Reversing lever

(Forward/ Switch lock/Reverse)

CAUTION: Set the main switch at OFF and wait until the bit has come to a complete stop before operating this lever.

1. For reverse rotation, set the lever to reverse.
Check the direction of rotation before use.
2. After use, set the lever at the center (switch lock) position.

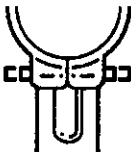

Ⓒ Variable speed control trigger

1. Depress the trigger slightly to start the tool slowly.
2. The speed increases with the amount of depression of the trigger for efficient tightening of screws. The brake operates when the trigger is released and the bit stops immediately.

CAUTION:

To eliminate excessive temperature increase of the tool surface, do not operate the tool continuously using two or more battery packs – tool needs cool off time before switching to another pack.

Ⓓ Battery pack

ATTENTION:

The product that you have purchased contains a rechargeable battery. The battery is recyclable. At the end of its useful life, under various state and local laws, it may be illegal to dispose of this battery into the municipal waste stream. Check with your local solid waste officials for details in your area for recycling options or proper disposal.

1. Press the battery pack release buttons Ⓔ on both sides and pull the pack away from the tool.
2. Charge the battery pack using the battery charger.
3. After the charging has been completed, remove the battery pack from the charger and connect it to the tool. Disconnect the charger from the power source when not in use.

The Lifespan of the Storage Battery

The storage battery has a limited life. If the operation time is extremely short after a proper charge, replace the battery with a new one. If the tool is not used frequently, charge the battery at least once in 6 months to maintain battery performance.

Note: Use under extremely hot or cold conditions will reduce operation capacity on a single charge.

Ⓔ Battery pack release button

F Battery charger

Note: When you charge the battery pack for the first time, or after prolonged storage, charge it for about 24 hours to bring the batteries up to full capacity.

EY0202 (Cat. No. EY0202B7658)

1. Plug the charger into the power source.
2. Insert the battery pack firmly into the charger.

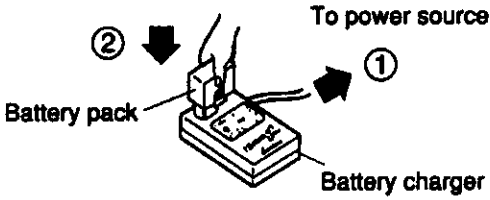

4. When charging is completed, the charging lamp **G** will start flashing quickly.
 - If a fully charged battery pack is inserted into the charger again, the charging lamp may light up and then flash quickly soon to indicate the charging is completed.
5. If the charging lamp does not turn on immediately after the charger has been plugged in, or if after standard charging time, the lamp does not go off, consult an authorized dealer for advice.

G Charging lamp

H Standby lamp

3. During charging, the charging lamp will light up. When the charge is completed, an internal electronic switch will automatically be triggered to prevent overcharging.
 - Charging will not occur if the battery pack is warm (for example, immediately after heavy-duty operation). The orange standby lamp **H** will light up until the battery becomes cool. Charging will then begin automatically.

Lamp Indications of EY0202

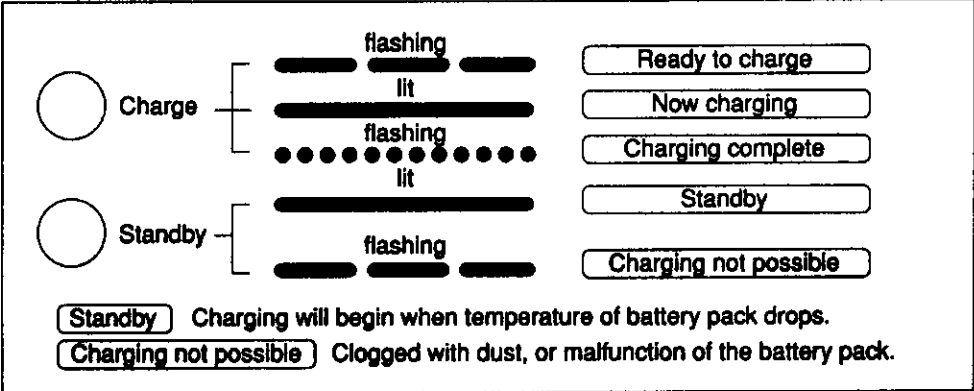

SPECIFICATIONS

MAIN UNIT

Model	EY6588
Motor	DC Motor 9.6V
No Load Speed	0 - 2200 min ⁻¹ (r.p.m.)
Impact Frequency	0-3300 Impacts/min
Maximum Torque	73.5Nm (750kg-cm, 650 in. lbs.)
Overall Length	175 mm (6-7/8")
Mass (Weight) with battery pack	1.35 kg (2.97 lbs.)

BATTERY PACK

Model (Battery type)	EY9086 (Compact)
Storage Battery	Ni-Cd Battery
Battery Voltage	9.6 V DC (1.2 V X 8 cells)

BATTERY CHARGER

Model	EY0202
Input	120 V AC
Applicable battery pack	EY9086
Charging time	Approx. 15 min.
Mass (Weight)	0.66 kg (1.45 lbs.)