

## OPERATION AND MAINTENANCE MANUAL FOR SERIES QA1L HIGH TORQUE REVERSIBLE ANGLE SCREWDRIVERS AND ANGLE WRENCHES

### NOTICE

Series QA1L Angle Screwdrivers and Angle Wrenches are designed for running small threaded fasteners in close-quarter applications. Ingersoll-Rand is not responsible for customer modification of tools for applications on which Ingersoll-Rand was not consulted.

### ⚠ WARNING

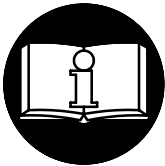

**IMPORTANT SAFETY INFORMATION ENCLOSED.  
READ THIS MANUAL BEFORE OPERATING TOOL.  
IT IS THE RESPONSIBILITY OF THE EMPLOYER TO PLACE THE INFORMATION  
IN THIS MANUAL INTO THE HANDS OF THE OPERATOR.  
FAILURE TO OBSERVE THE FOLLOWING WARNINGS COULD RESULT IN INJURY.**

#### PLACING TOOL IN SERVICE

- Always operate, inspect and maintain this tool in accordance with American National Standards Institute Safety Code for Portable Air Tools (ANSI B186.1).
- For safety, top performance, and maximum durability of parts, operate this tool at 90 psig (6.2 bar/620 kPa) maximum air pressure at the inlet with 1/4" (6 mm) inside diameter air supply hose.
- Always turn off the air supply and disconnect the air supply hose before installing, removing or adjusting any accessory on this tool, or before performing any maintenance on this tool.
- Do not use damaged, frayed or deteriorated air hoses and fittings.
- Be sure all hoses and fittings are the correct size and are tightly secured. See Dwg. TPD905-1 for a typical piping arrangement.
- Always use clean, dry air at 90 psig (6.2 bar/620 kPa) maximum air pressure. Dust, corrosive fumes and/or excessive moisture can ruin the motor of an air tool.
- Do not lubricate tools with flammable or volatile liquids such as kerosene, diesel or jet fuel.
- Do not remove any labels. Replace any damaged label.

#### USING THE TOOL

- Always wear eye protection when operating or performing maintenance on this tool.
- Always wear hearing protection when operating this tool.
- Keep hands, loose clothing and long hair away from rotating end of tool.
- Note the position of the reversing lever before operating the tool so as to be aware of the direction of rotation when operating the throttle.
- Anticipate and be alert for sudden changes in motion during start up and operation of any power tool.
- Keep body stance balanced and firm. Do not overreach when operating this tool. High reaction torques can occur at or below the recommended air pressure.
- Tool accessory may continue to rotate briefly after throttle is released.
- Air powered tools can vibrate in use. Vibration, repetitive motions or uncomfortable positions may be harmful to your hands and arms. Stop using any tool if discomfort, tingling feeling or pain occurs. Seek medical advice before resuming use.
- Use accessories recommended by Ingersoll-Rand.
- This tool is not insulated against electric shock.
- This tool is not designed for working in explosive atmospheres.

### NOTICE

The use of other than genuine Ingersoll-Rand replacement parts may result in safety hazards, decreased tool performance, and increased maintenance, and may invalidate all warranties.

Repairs should be made only by authorized trained personnel. Consult your nearest Ingersoll-Rand Authorized Servicenter.

Refer All Communications to the Nearest Ingersoll-Rand Office or Distributor.

© Ingersoll-Rand Company 2000

Printed in U.S.A.



# WARNING LABEL IDENTIFICATION

## ⚠ WARNING

FAILURE TO OBSERVE THE FOLLOWING WARNINGS COULD RESULT IN INJURY.

	<p><b>⚠ WARNING</b></p> <p>Always wear eye protection when operating or performing maintenance on this tool.</p>
---	--

	<p><b>⚠ WARNING</b></p> <p>Always wear hearing protection when operating this tool.</p>
---	---

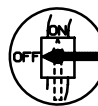
	<p><b>⚠ WARNING</b></p> <p>Always turn off the air supply and disconnect the air supply hose before installing, removing or adjusting any accessory on this tool, or before performing any maintenance on this tool.</p>
---	--

	<p><b>⚠ WARNING</b></p> <p>Air powered tools can vibrate in use. Vibration, repetitive motions or uncomfortable positions may be harmful to your hands and arms. Stop using any tool if discomfort, tingling feeling or pain occurs. Seek medical advice before resuming use.</p>
---	---

	<p><b>⚠ WARNING</b></p> <p>Do not carry the tool by the hose.</p>
---	---

	<p><b>⚠ WARNING</b></p> <p>Do not use damaged, frayed or deteriorated air hoses and fittings.</p>
---	---

	<p><b>⚠ WARNING</b></p> <p>Keep body stance balanced and firm. Do not overreach when operating this tool.</p>
---	---

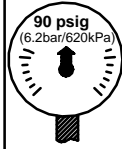
	<p><b>⚠ WARNING</b></p> <p>Operate at 90 psig (6.2 bar/ 620 kPa) Maximum air pressure.</p>
---	--

## ADJUSTMENTS

### CLUTCH ADJUSTMENT

#### ⚠ WARNING

**Disconnect the air supply from the Tool before proceeding.**

1. Rotate the Clutch Adjusting Hole Cover to expose the clutch adjusting hole in the Clutch Housing.
2. Insert a 1/4" hex wrench into the Spindle or a wrench on the square driver and rotate the clutch mechanism until the area having an opening between the faces of the Clutch Adjusting Nut Washer and Clutch Adjusting Nut is visible.

3. Using a screwdriver that has a #1 Phillips tip, insert the tip of the screwdriver into the opening and rotate the screwdriver to adjust the Clutch. Rotate the screwdriver clockwise to decrease Clutch Spring tension and torque and counterclockwise to increase the tension and torque.

#### NOTICE

**The most satisfactory adjustment is usually obtained by using the tool on the actual application and increasing or decreasing the delivered torque until the desired setting is reached. In any event, it is recommended that final adjustment be made by gradual progression.**

# PLACING TOOL IN SERVICE

## LUBRICATION



Ingersoll-Rand No. 10



Gearing:

Ingersoll-Rand No. 67

Clutch:

Ingersoll-Rand No. 28

Always use an air line lubricator with this tool.  
We recommend the following Filter-Lubricator-Regulator Unit:

**For USA – No. C08-02-FKG0-28**

**Whenever the tool is disassembled for maintenance or repair,** lubricate the gear train with Ingersoll-Rand No. 67 Grease.

**Whenever the tool is disassembled for maintenance or repair,** lubricate the clutch assembly with Ingersoll-Rand No. 28 Grease.

**After every 40,000 cycles or one month,** or as experience indicates, inject 2 to 4 cc of Ingersoll-Rand No. 67 Grease into the Grease Fitting on the Angle Attachment.

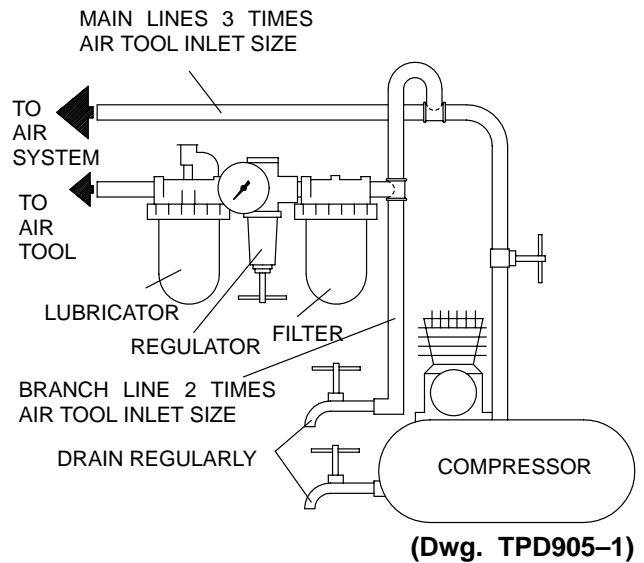

## MODEL IDENTIFICATION

Tool Style	Rotation	Throttle	Free Speed	Clutch	Bit Holder or Driver	Angle Head	Accessory
<b>QA</b> (Angle)	<b>1</b> (Reversible)	<b>L</b> (Lever Start)	<b>05</b> (0500) <b>02</b> (0250)	<b>S</b> (Automatic Shut-off) <b>C</b> (Cushion Clutch)	<b>1</b> (1/4" Quick Release) <b>6</b> (3/8" Square Drive) <b>9</b> (1/4" Wire Detent Hex Bit Holder)	<b>XL</b> (Large)	<b>D</b> (Memory Chip) <b>B</b> (1/4-19 BSPT Inlet)
			<b>QA</b>				
			<b>1</b>				
				<b>L</b>			
			<b>05</b>				
				<b>S</b>			
					<b>1</b>		
					<b>XL</b>		
						<b>D</b>	

# MANUEL D'EXPLOITATION ET D'ENTRETIEN POUR VISSEUSES D'ANGLE ET CLÉS D'ANGLE RÉVERSIBLES A COUPLE ÉLEVÉ SÉRIE QA1L

## NOTE

Les tournevis et clés d'angle réversibles de la série QA1L sont destinés au montage des petites fixations filetées dans des espaces restreints.

Ingersoll-Rand ne peut être tenu responsable de la modification des outils par le client pour les adapter à des applications qui n'ont pas été approuvées par Ingersoll-Rand.

## ⚠ ATTENTION

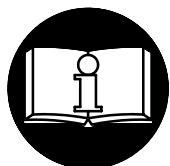

**D'IMPORTANTES INFORMATIONS DE SECURITÉ SONT JOINTES.  
LIRE CE MANUEL AVANT D'UTILISER L'OUTIL.  
L'EMPLOYEUR EST TENU À COMMUNIQUER LES INFORMATIONS  
DE CE MANUEL AUX EMPLOYÉS UTILISANT CET OUTIL.**

**LE NON RESPECT DES AVERTISSEMENTS SUIVANTS PEUT CAUSER DES BLESSURES**

### MISE EN SERVICE DE L'OUTIL

- Toujours exploiter, inspecter et entretenir cet outil conformément au Code de sécurité des outils pneumatiques portatifs de l'American National Standards Institute (ANSI B186.1).
- Pour la sécurité, les performances optimales et la durabilité maximale des pièces, cet outil doit être connecté à une alimentation d'air comprimé de 6,2 bar (620 kPa) maximum à l'entrée, avec un flexible de 6 mm de diamètre intérieur.
- Couper toujours l'alimentation d'air comprimé et débrancher le flexible d'alimentation avant d'installer, déposer ou ajuster tout accessoire sur cet outil, ou d'entreprendre une opération d'entretien quelconque sur l'outil.
- Ne pas utiliser des flexibles ou des raccords endommagés, effilochés ou détériorés.
- S'assurer que tous les flexibles et les raccords sont correctement dimensionnés et bien serrés. Voir Plan TPD905-1 pour un exemple type d'agencement des tuyauteries.
- Utiliser toujours de l'air sec et propre à une pression maximum de 6,2 bar (620 kPa). La poussière, les fumées corrosives et/ou une humidité excessive peuvent endommager le moteur d'un outil pneumatique.
- Ne jamais lubrifier les outils avec des liquides inflammables ou volatils tels que le kérosène, le gasol ou le carburant d'aviation.
- Ne retirer aucune étiquette. Remplacer toute étiquette endommagée.

### UTILISATION DE L'OUTIL

- Porter toujours des lunettes de protection pendant l'utilisation et l'entretien de cet outil.
- Porter toujours une protection acoustique pendant l'utilisation de cet outil.
- Tenir les mains, les vêtements fous et les cheveux longs, éloignés de l'extrémité rotative de l'outil.
- Noter la position du levier d'inversion avant de mettre l'outil en marche de manière à savoir dans quel sens il va tourner lorsque la commande est actionnée.
- Prévoir, et ne pas oublier, que tout outil motorisé est susceptible d'à-coups brusques lors de sa mise en marche et pendant son utilisation.
- Garder une position équilibrée et ferme. Ne pas se pencher trop en avant pendant l'utilisation de cet outil. Des couples de réaction élevés peuvent se produire à, ou en dessous, de la pression d'air recommandée.
- La percussion des accessoires de l'outil peut continuer pendant un certain temps après le relâchement de la gâchette.
- Les outils pneumatiques peuvent vibrer pendant l'exploitation. Les vibrations, les mouvements répétitifs et les positions inconfortables peuvent causer des douleurs dans les mains et les bras. N'utiliser plus d'outils en cas d'inconfort, de picotements ou de douleurs. Consulter un médecin avant de recommencer à utiliser l'outil.
- Utiliser les accessoires recommandés par Ingersoll-Rand.
- Cet outil n'est pas conçu pour fonctionner dans des atmosphères explosives.
- Cet outil n'est pas isolé contre les chocs électriques.

## NOTE

L'utilisation de rechanges autres que les pièces d'origine Ingersoll-Rand peut causer des risques d'insécurité, réduire les performances de l'outil et augmenter l'entretien, et peut annuler toutes les garanties.

Les réparations ne doivent être effectuées que par des réparateurs qualifiés autorisés. Consultez votre Centre de Service Ingersoll-Rand le plus proche.

Adressez toutes vos communications au Bureau Ingersoll-Rand ou distributeur le plus proche.

© Ingersoll-Rand Company 2000

Imprimé aux É.U.



# SIGNIFICATION DES ÉTIQUETTES D'AVERTISSEMENT

## ⚠ ATTENTION

### LE NON RESPECT DES AVERTISSEMENTS SUIVANTS PEUT CAUSER DES BLESSURES

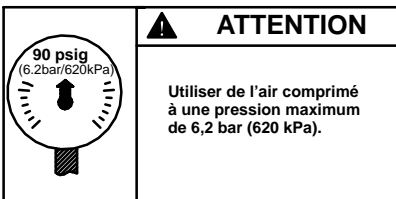
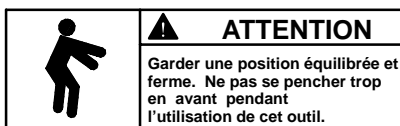
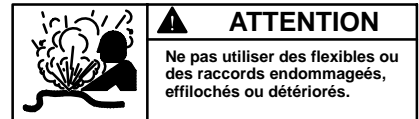
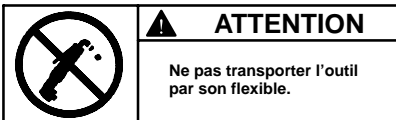
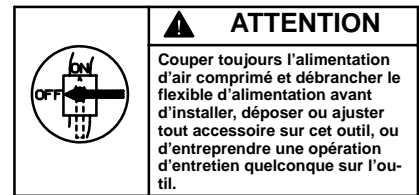
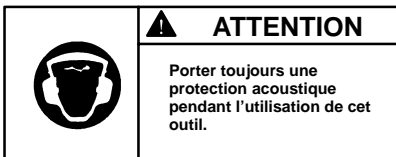
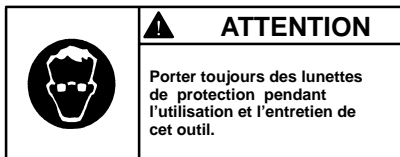

## RÉGLAGES

### REGLAGE DU LIMITEUR

#### ⚠ ATTENTION

**Débrancher l'alimentation d'air comprimé de l'outil avant d'entreprendre les opérations suivantes.**

1. Tourner la bague pour accéder au trou de réglage du limiteur.
2. Insérer une clé hexagonale de ¼" dans la broche ou une clé sur le carré entraîneur et tourner le mécanisme du limiteur jusqu'à ce que la zone ayant une ouverture entre les faces de la rondelle et de l'écrou de réglage du limiteur soit visible.

3. A l'aide d'un tournevis Phillips No.1, insérer la lame du tournevis dans l'ouverture et tourner le tournevis pour régler le limiteur. Tourner le tournevis dans le sens horaire pour réduire la tension du ressort du limiteur et le couple, et dans le sens antihoraire pour augmenter la tension et le couple.

#### NOTE

**La meilleure méthode de réglage est normalement obtenue en utilisant l'outil sur l'application requise en augmentant ou en diminuant le couple fourni jusqu'à ce que le réglage désiré soit obtenu. De plus, il est toujours recommandé d'obtenir le réglage final au moyen de réglages progressifs.**

## MISE EN SERVICE DE L'OUTIL

### LUBRIFICATION



Ingersoll-Rand No. 10

Pignonnerie:  
Ingersoll-Rand No. 67



Limiteur:  
Ingersoll-Rand No. 28

Utiliser toujours un lubrificateur avec ces outils. Nous recommandons l'emploi du filtre-régulateur-lubrificateur suivant:

É.U. - No. C08-02-FKG0-28

Lubrifier le train d'engrenages avec de la graisse Ingersoll-Rand No. 67 à **chaque fois que l'outil est démonté pour entretien ou réparation.**

Lubrifier l'ensemble de limiteur avec de la graisse Ingersoll-Rand No. 28 à **chaque fois que l'outil est démonté pour entretien ou réparation.**

Tous les **40.000 cycles** ou au moins tous les mois, selon le cas, injecter 2 à 4 cm<sup>3</sup> de graisse Ingersoll-Rand No. 67 dans le raccord de graissage du renvoi d'angle.

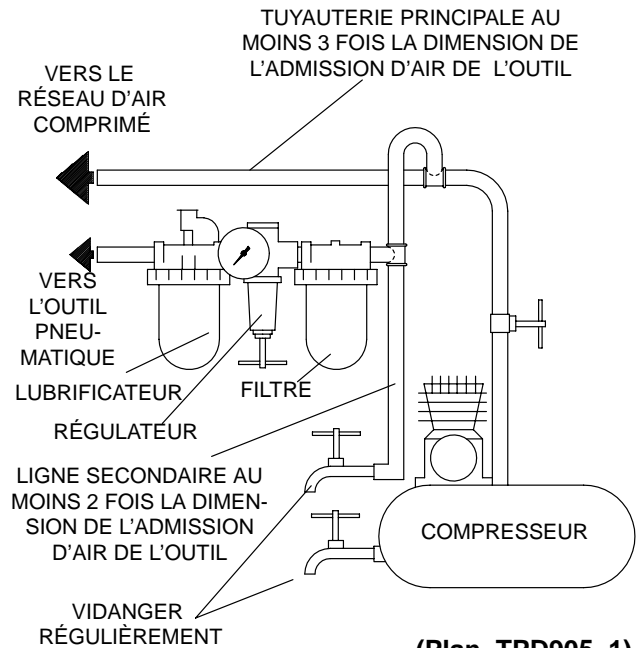

## IDENTIFICATION DES MODÈLES

Style d'outil	Rotation	Commande	Vitesse à vide	Limiteur	Porte-embout ou entraîneur	Renvoi d'angle	Accessoire
<b>QA</b> (Angle)	<b>1</b> (Réversible)	<b>L</b> (Démarrage par gâchette)	<b>05</b> (0500) <b>02</b> (0250)	<b>S</b> (Arrêt automatique) <b>C</b> (Limiteur amortisseur)	<b>1</b> (1/4" Changement rapide) <b>6</b> (Carré Entraîneur 3/8") <b>9</b> (Porte-embout hexagonal à détente 1/4")	<b>XL</b> (Large)	<b>D</b> (Puce mémoire) <b>B</b> (1/4-19 BSPT Tuyau d'entrée)

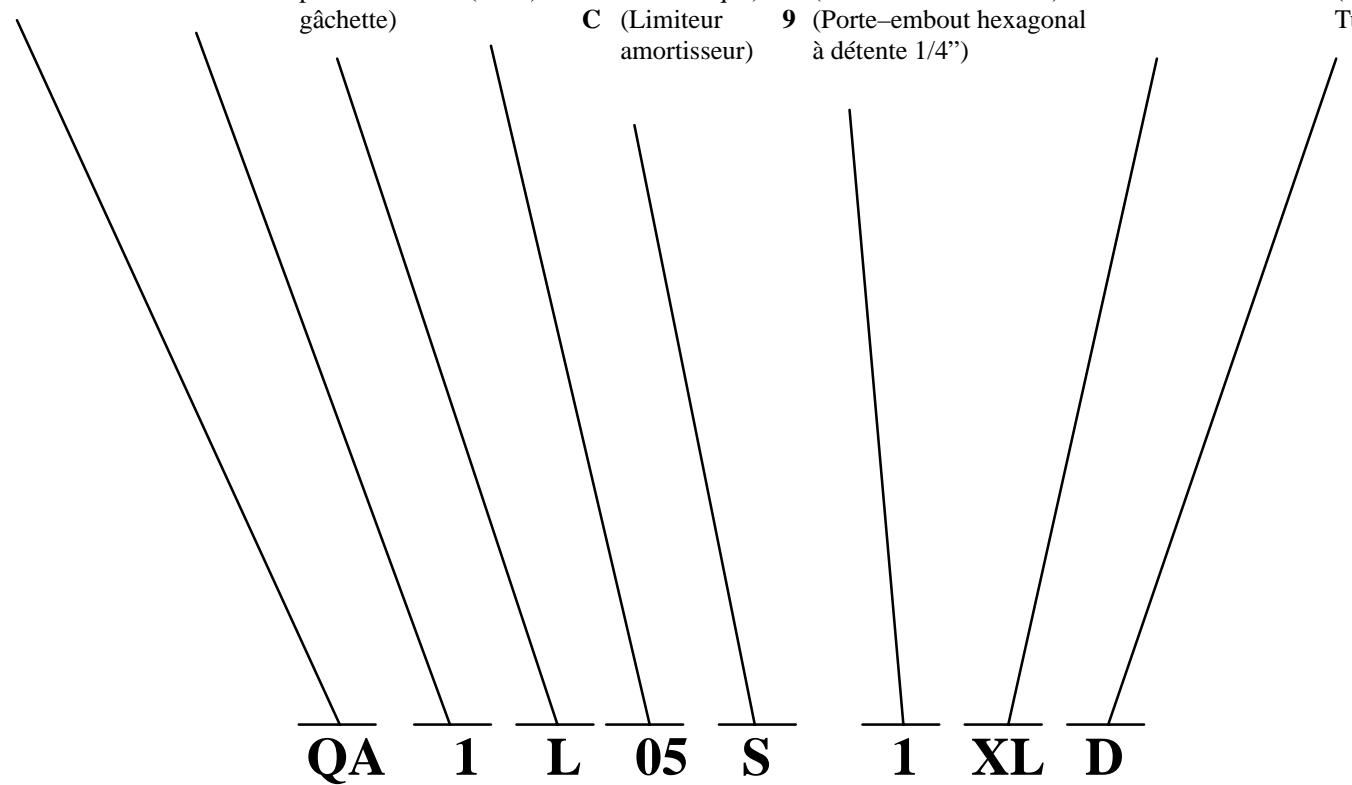



# MANUAL DE USO Y MANTENIMIENTO PARA LLAVES ANGULARES Y ATORNILLADORES ANGULARES REVERSIBLES DE ELEVADO PAR DE LA SERIE QA1L

## NOTA

Las Llaves Angulares y Atornilladores Angulares Serie QA1L están diseñadas para el atornillado de pequeñas uniones roscadas en aplicaciones de acceso reducido. Ingersoll–Rand no aceptará responsabilidad alguna por la modificación de las herramientas efectuada por el cliente para las aplicaciones que no hayan sido consultadas con Ingersoll–Rand.

## ⚠ AVISO

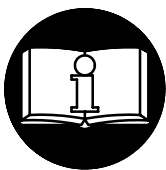

**SE ADJUNTA INFORMACION IMPORTANTE DE SEGURIDAD.  
LEA ESTE MANUAL ANTES DE USAR LA HERRAMIENTA.  
ES RESPONSABILIDAD DE LA EMPRESA ASEGURARSE DE QUE EL OPERARIO  
ESTE AL TANTO DE LA INFORMACION QUE CONTIENE ESTE MANUAL.  
EL HACER CASO OMISO DE LOS AVISOS SIGUIENTES PODRIA OCASIONAR LESIONES.**

### PARA PONER LA HERRAMIENTA EN SERVICIO

- Utilice, examine y mantenga siempre esta herramienta conforme al código de seguridad para herramientas neumáticas portátiles de la American National Standards Institute (ANSI B186.1).
- Para seguridad, máximo rendimiento y durabilidad de piezas, use esta herramienta a una máxima presión de aire de 90 psig (6,2 bar/620kPa) en la admisión de manguera de suministro de aire de diámetro interno de 6 mm.
- Corte siempre el suministro de aire y desconecte la manguera de suministro de aire antes de instalar, desmontar o ajustar cualquier accesorio de esta herramienta, o antes de realizar cualquier operación de mantenimiento de la misma.
- No utilice mangueras de aire y accesorios dañados, desgastados ni deteriorados.
- Asegúrese de que todas las mangueras y los accesorios sean del tamaño correcto y estén bien apretados. Vea Esq. TPD905–1 para un típico arreglo de tuberías.
- Use siempre aire limpio y seco a una máxima presión de 90 psig (6,2 bar/620kPa). El polvo, los gases corrosivos y/o el exceso de humedad podrían estropear el motor de una herramienta neumática.
- No lubrique las herramientas con líquidos inflamables o volátiles tales como queroseno, gasoil o combustible para motores a reacción.
- No saque ninguna etiqueta. Sustituya toda etiqueta dañada.

### USO DE HERRAMIENTA

- Use siempre protección ocular cuando utilice esta herramienta o realice operaciones de mantenimiento en la misma.
- Use siempre protección para los oídos cuando utilice esta herramienta.
- Mantenga las manos, la ropa suelta y el cabello largo alejados del extremo giratorio de la herramienta.
- Note la posición de la palanca de inversión antes de funcionar la herramienta para estar consciente de su dirección giratoria cuando funcione el estrangulador.
- Anticipe y esté alerta a los cambios repentinos en el movimiento durante la puesta en marcha y el manejo de toda herramienta motorizada.
- Mantenga una postura de cuerpo equilibrada y firme. No estire demasiado los brazos al manejar la herramienta. Pueden ocurrir reacciones de alto par a, o menos de, la recomendada presión de aire.
- El accesorio de herramienta podría seguir girando brevemente después de haber soltado la palanca de estrangulación.
- Las herramientas neumáticas pueden vibrar durante el uso. La vibración, repetición o posiciones incómodas pueden dañarle los brazos y manos. En caso de incomodidad, sensación de hormigueo o dolor, deje de usar la herramienta. Consulte a un médico antes de volver a usarla otra vez.
- Utilice únicamente los accesorios Ingersoll–Rand recomendados.
- Esta herramienta no ha sido diseñada para trabajar en ambientes explosivos.
- Esta herramienta no está aislada contra descargas eléctricas.

## NOTA

El uso de piezas de recambio que no sean las auténticas piezas Ingersoll–Rand podría poner en peligro la seguridad, reducir el rendimiento de la herramienta y aumentar los cuidados de mantenimiento necesarios, así como invalidar toda garantía.

Las reparaciones sólo serán realizadas por personal cualificado y autorizado. Consulte con el centro de servicio Ingersoll–Rand autorizado más próximo.

Toda comunicación se deberá dirigir a la oficina o al distribuidor Ingersoll–Rand más próximo.

© Ingersoll–Rand Company 2000

Impreso en EE. UU.



## ETIQUETAS DE AVISO

### ⚠ AVISO

EL HACER CASO OMISO DE LOS AVISOS SIGUIENTES PODRIA OCASIONAR LESIONES.

	<b>⚠ ADVERTENCIA</b> Use siempre protección ocular cuando utilice esta herramienta o realice operaciones de mantenimiento en la misma.
---	---

	<b>⚠ ADVERTENCIA</b> Use siempre protección para los oídos cuando utilice esta herramienta.
---	--

	<b>⚠ ADVERTENCIA</b> Cortar siempre el suministro de aire y desconectar la manguera de suministro de aire antes de instalar, retirar o ajustar cualquier accesorio de esta herramienta, o antes de realizar cualquier operación de mantenimiento de la misma.
---	--

	<b>⚠ ADVERTENCIA</b> Las herramientas neumáticas pueden vibrar durante el uso. La vibración, los movimientos repetitivos o las posiciones incómodas podrían dañarle los brazos y las manos. En caso de incomodidad, sensación de hormigueo o dolor, dejar de usar la herramienta. Consultar al médico antes de volver a utilizarla.
---	--

	<b>⚠ ADVERTENCIA</b> No coger la herramienta por la manguera para levantarla.
---	--

	<b>⚠ ADVERTENCIA</b> No utilizar mangueras de aire y accesorios dañados, desgastados ni deteriorados.
---	--

	<b>⚠ ADVERTENCIA</b> Mantener una postura del cuerpo equilibrada y firme. No estirar demasiado los brazos al manejar la herramienta.
---	---

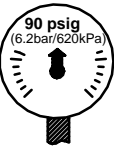
	<b>⚠ ADVERTENCIA</b> Manejar la herramienta a una presión de aire máxima de 90 psig (6,2 bar/620 kPa).
---	---

## AJUSTES

### AJUSTE DE EMBRAGUE

#### ⚠ AVISO

**Desconecte el suministro de aire comprimido de la herramienta antes de proceder.**

1. Mueva la tapa de orificio de ajuste en la carcasa de embrague para ver el orificio de ajuste.
2. Introduzca una llave hexagonal de 1/4" en el husillo o una llave en el cuadradillo y haga girar el mecanismo del embrague hasta que sea visible la zona donde hay una abertura entre las caras de la arandela de la tuerca de ajuste del embrague y la tuerca de ajuste del embrague.

3. Introduzca la punta de un atornillador con punta Phillips nº 1 en la abertura y gire el atornillador para ajustar el embrague. Gire el atornillador hacia la derecha para reducir la tensión y el par del muelle del embrague o hacia la izquierda para aumentarlos.

#### NOTA

**Normalmente se obtendrá el mejor ajuste usando la herramienta en trabajo actual e incrementando o disminuyendo el par hasta lograr el ajuste deseado. En cualquier caso, se recomienda hacer el ajuste final por progresión gradual.**

# PARA PONER LA HERRAMIENTA EN SERVICIO

## LUBRICACION



Ingersoll-Rand N° 10



Engranajes:

Ingersoll-Rand N° 67

Embrague:

Ingersoll-Rand N° 28

Utilice siempre un lubricador de aire comprimido con estas llaves de impacto. Recomendamos la siguiente unidad de Filtro-Lubricador-Regulador:

EE.UU. - N° C08-02-FKG0-28

**Cada vez que se desarme la herramienta para realizarle trabajos de mantenimiento o reparación, lubrique el tren de engranajes con grasa Ingersoll-Rand N° 67.**

**Cada vez que se desarme la herramienta para realizarle trabajos de mantenimiento o reparación, lubrique el conjunto del embrague con grasa Ingersoll-Rand N° 28.**

**Después de cada 40,000 ciclos o un mes de uso, o según indique la experiencia, inyecte 2-4 cc de grasa Ingersoll-Rand N° 67 en el engrasador de la cabeza angular.**

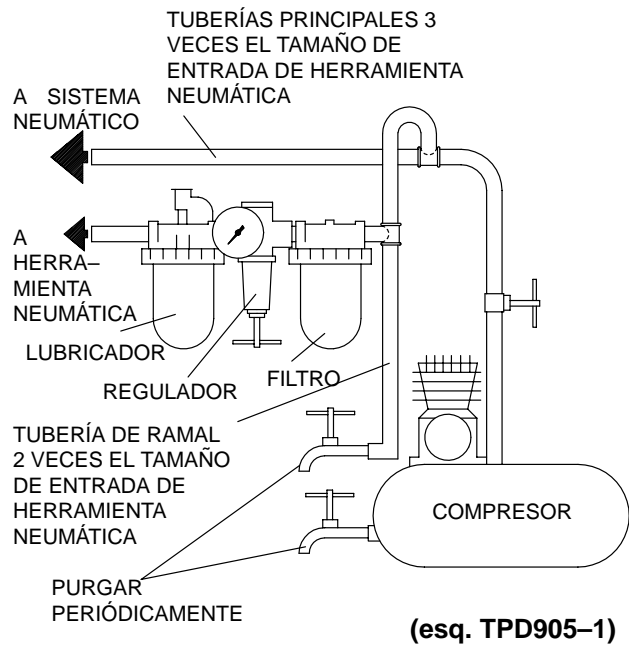

# IDENTIFICACIÓN DE MODELOS

Estilo de herramienta	Rotación	Palanca de mando	Velocidad	Embrague en vacío	Portapuntas o cuadradrillo	Cabeza Angular	Accesorio
<b>QA</b> (Angular)	<b>1</b> (Reversible)	<b>L</b> (Arranque por Palanca)	<b>05</b> (0500) <b>02</b> (0250)	<b>S</b> (Parada automática) <b>C</b> (Embrague ajustable)	<b>1</b> (de cambio rápido 1/4") <b>6</b> (Cuadradrillo de 3/8") <b>9</b> (Portapuntas exagonal con alambre de retención de 1/4")	<b>XL</b> (Grande)	<b>D</b> (Chip de memoria) <b>B</b> (1/4-19 BSPT Boca)

**QA**
**1**
**L**
**05**
**S**
**1**
**XL**
**D**

# MANUAL DE FUNCIONAMENTO E MANUTENÇÃO PARA APARAFUSADORAS E CHAVES INGLESAS EM ÂNGULO REVERSÍVEIS DE BINÁRIO ELEVADO SÉRIE QA1L

## AVISO

As Aparafusadoras e Ferramentas Pneumáticas Angulares Séries QA1L são concebidas para accionar apertadores de rosca pequenos em aplicações em espaços reduzidos.

A Ingersoll–Rand não é responsável por modificações, feitas pelo cliente em ferramentas, nas quais a Ingersoll–Rand não tenha sido consultada.

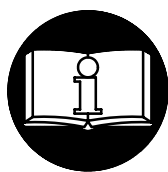

## ⚠️ ADVERTÊNCIA

**INFORMAÇÃO DE SEGURANÇA IMPORTANTE EM ANEXO  
LEIA ESTE MANUAL ANTES DE OPERAR A FERRAMENTA.  
É DA RESPONSABILIDADE DO EMPREGADOR COLOCAR  
A INFORMAÇÃO DESTE MANUAL NAS MÃOS DO OPERADOR.**

**O NÃO CUMPRIMENTO DAS SEGUINTE ADVERTÊNCIAS PODE RESULTAR EM FERIMENTOS.**

### COLOCANDO A FERRAMENTA EM FUNCIONAMENTO

- Sempre opere, inspeccione e mantenha esta ferramenta de acordo com o Código de Segurança do Instituto Americano de Padrões Nacionais para Ferramentas Pneumáticas Portáteis (ANSI B186.1).
- Para segurança, máximo desempenho e máxima durabilidade das peças, opere esta ferramenta com uma pressão de ar máxima de 6,2 bar/620 kPa (90 psig) na entrada da mangueira de alimentação de ar com diâmetro interno de 6 mm (1/4”).
- Desligue sempre a alimentação de ar e desconecte a mangueira de alimentação de ar antes de instalar, remover ou ajustar qualquer acessório nesta ferramenta, ou antes de executar qualquer serviço de manutenção nesta ferramenta.
- Não use mangueiras de ar ou adaptadores danificados, gastos ou deteriorados.
- Certifique-se de que todas as mangueiras e adaptadores sejam do tamanho correcto e estejam apertados com firmeza. Veja o Desenho TPD905–1 para um arranjo típico de tubagem.
- Use sempre ar seco e limpo com pressão máxima de 6,2 bar/620 kPa (90 psig). Pó, fumos corrosivos e/ou humidade excessiva podem arruinar o motor de uma ferramenta pneumática.
- Não lubrifique as ferramentas com líquidos inflamáveis ou voláteis tais como querosene, diesel ou combustível de jactos.
- Não remova nenhum rótulo. Reponha qualquer rótulo danificado.

### USANDO A FERRAMENTA

- Use sempre óculos de protecção quando estiver operando ou executando serviço de manutenção nesta ferramenta.

- Use sempre protecção contra ruído ao operar esta ferramenta.
- Mantenha as mãos, partes do vestuário soltas e cabelos compridos afastados da extremidade em rotação.
- Observe qual é a posição da alavanca que reverte o sentido de rotação antes de operar esta ferramenta de modo a estar atento ao sentido de rotação quando operar o regulador de pressão.
- Antecipe e esteja alerta a mudanças repentinas no movimento quando ligar e operar qualquer ferramenta motorizada.
- Mantenha a posição do corpo equilibrada e firme. Não exagere quando operar esta ferramenta. Torques de reacção elevados podem ocorrer na ou abaixo da pressão de ar recomendada.
- Os acessórios da ferramenta podem continuar a girar brevemente após a pressão ter sido aliviada.
- Ferramentas accionadas pneumáticamente podem vibrar em uso. Vibração, movimentos repetitivos ou posições desconfortáveis podem ser prejudiciais às mãos e aos braços. Pare de usar a ferramenta caso ocorra algum desconforto, sensação de formigamento ou dor. Procure assistência médica antes de retornar ao trabalho.
- Use acessórios recomendados pela Ingersoll–Rand.
- Esta Ferramenta não foi concebida para trabalhos em atmosferas explosivas.
- Esta Ferramenta não está isolada contra choques eléctricos.

## AVISO

O uso de peças de substituição que não sejam genuinamente da Ingersoll–Rand podem resultar em riscos de segurança, diminuição do desempenho da ferramenta, aumento da necessidade de manutenção e pode invalidar todas as garantias.

As reparações devem ser feitas somente por pessoal treinado autorizado. Consulte o Centro de Serviços da Ingersoll–Rand mais próximo.

Envie Todos os Comunicados Para o Distribuidor ou Escritório da Ingersoll–Rand Mais Próximo.

© Ingersoll–Rand Company 2000  
Impresso nos E.U.A.



# IDENTIFICAÇÃO DO RÓTULO DE ADVERTÊNCIA

## ▲ ADVERTÊNCIA

O NÃO CUMPRIMENTO DAS SEGUINTES ADVERTÊNCIAS PODE RESULTAR EM FERIMENTO.

	<b>▲ ADVERTÊNCIA</b> Use sempre óculos de protecção quando estiver operando ou executando algum serviço de manutenção nesta ferramenta.
---	--

	<b>▲ ADVERTÊNCIA</b> Use sempre protecção contra o ruído ao operar esta ferramenta.
---	--

	<b>▲ ADVERTÊNCIA</b> Desligue sempre a alimentação de ar e desconecte a mangueira de alimentação de ar antes de instalar, remover ou ajustar qualquer acessório nesta ferramenta, ou antes de executar algum serviço de manutenção nesta ferramenta.
---	---

	<b>▲ ADVERTÊNCIA</b> Ferramentas accionadas pneumáticamente podem vibrar em uso. Vibração, movimentos repetitivos ou posições desconfortáveis podem ser prejudiciais às mãos e aos braços. Pare de usar a ferramenta caso ocorra algum desconforto, sensação de formigueiro ou dor. Procure assistência médica antes de retornar ao trabalho.
---	--

	<b>▲ ADVERTÊNCIA</b> Não carregue a ferramenta segurando na mangueira.
---	---

	<b>▲ ADVERTÊNCIA</b> Não use mangueiras de ar ou adaptadores danificados, gastos ou deteriorados.
---	--

	<b>▲ ADVERTÊNCIA</b> Mantenha a posição do corpo equilibrada e firme. Não exagere quando operar esta ferramenta. Torques de reacção elevados podem ocorrer sob a pressão de ar recomendada.
---	--

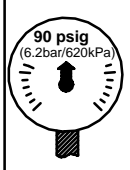
	<b>▲ ADVERTÊNCIA</b> Opere com pressão de ar Máxima de 90-100 psig(6,2-6,9bar).
---	--

## AJUSTES

### AJUSTE DA EMBRAIAGEM

#### ▲ ADVERTÊNCIA

**Desconecte a alimentação de ar da Ferramenta antes de prosseguir.**

1. Rode a tampa do orifício de ajuste da embraiagem para expor este orifício na carcaça da embraiagem.
2. Introduza uma chave sextavada de 1/4" na haste ou uma chave inglesa no accionamento quadrado e rode o mecanismo da embraiagem até a área que tem uma abertura entre as faces da anilha e da porca de ajuste da embraiagem ficar visível.

3. Introduza a ponta de uma chave de fendas Phillips Nº 1 na abertura e rode a chave de fendas para ajustar a embraiagem. Rode a chave para a direita para reduzir a tensão e o binário da mola da embraiagem e para a esquerda para aumentar a tensão e o binário.

#### AVISO

**O ajuste mais satisfatório é usualmente obtido ao utilizar a ferramenta na aplicação real e aumentando ou diminuindo o torque exercido até que o ajuste desejado seja atingido. Em qualquer caso, é recomendado que o ajuste final seja feito em progressivamente.**

# COLOCANDO A FERRAMENTA EM FUNCIONAMENTO

## LUBRIFICAÇÃO



Ingersoll-Rand No. 10



Engrenagem:  
Ingersoll-Rand No. 67  
Embraiagem:  
Ingersoll-Rand No. 28

Use sempre um lubrificador de ar de linha com estas ferramentas. Nós recomendamos a seguinte Unidade Filtro-Lubrificador-Regulador:

Para E.U.A. – No. C08-02-FKG0-28

**Sempre que a ferramenta for desmontada para manutenção ou reparação,** lubrifique o trem de engrenagens com Massa Ingersoll-Rand Nº 67.

**Sempre que a ferramenta for desmontada para manutenção ou reparação,** lubrifique o conjunto da embraiagem com Massa Ingersoll-Rand Nº 28.

**Após cada 40 000 ciclos ou um mês, ou conforme a experiência indicar,** injecte 2 a 4 cc de Massa Lubrificante Ingersoll-Rand Nº 67 no copo de lubrificação do acessório em ângulo.

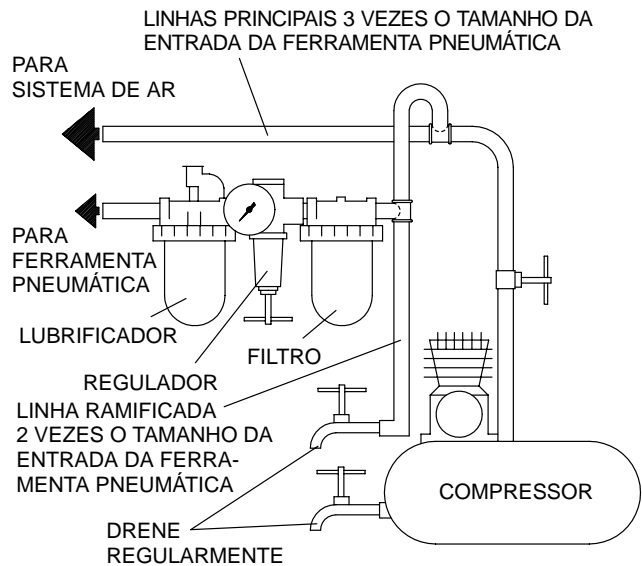

(Desenho TPD905-1)

## MODEL IDENTIFICATION

Estilo da ferramenta	Rotação	Estrangulador	Velocidade livre	Embraiagem	Porta-brocas ou accionador	Cabeça em Ângulo	Acessório
QA (Ângulo)	1 (Reversível)	L (Arranque por Alavanca)	05 (0500) 02 (0250)	S (Desligamento automático) C (Embraiagem amortecedora)	1 (Libertação rápida de 1/4") 6 (Accionamento quadrado de 3/8") 9 (Porta-brocas sextavado de 1/4", fixa com arame)	XL (Grande)	D (Chip de memória) B (1/4-19 BSPT Entrada)

  

<b>QA</b>	<b>1</b>	<b>L</b>	<b>05</b>	<b>S</b>	<b>1</b>	<b>XL</b>	<b>D</b>
-----------	----------	----------	-----------	----------	----------	-----------	----------



# SERIES QA1L HIGH TORQUE ANGLE FASTENER MOTOR AND GEARING

17

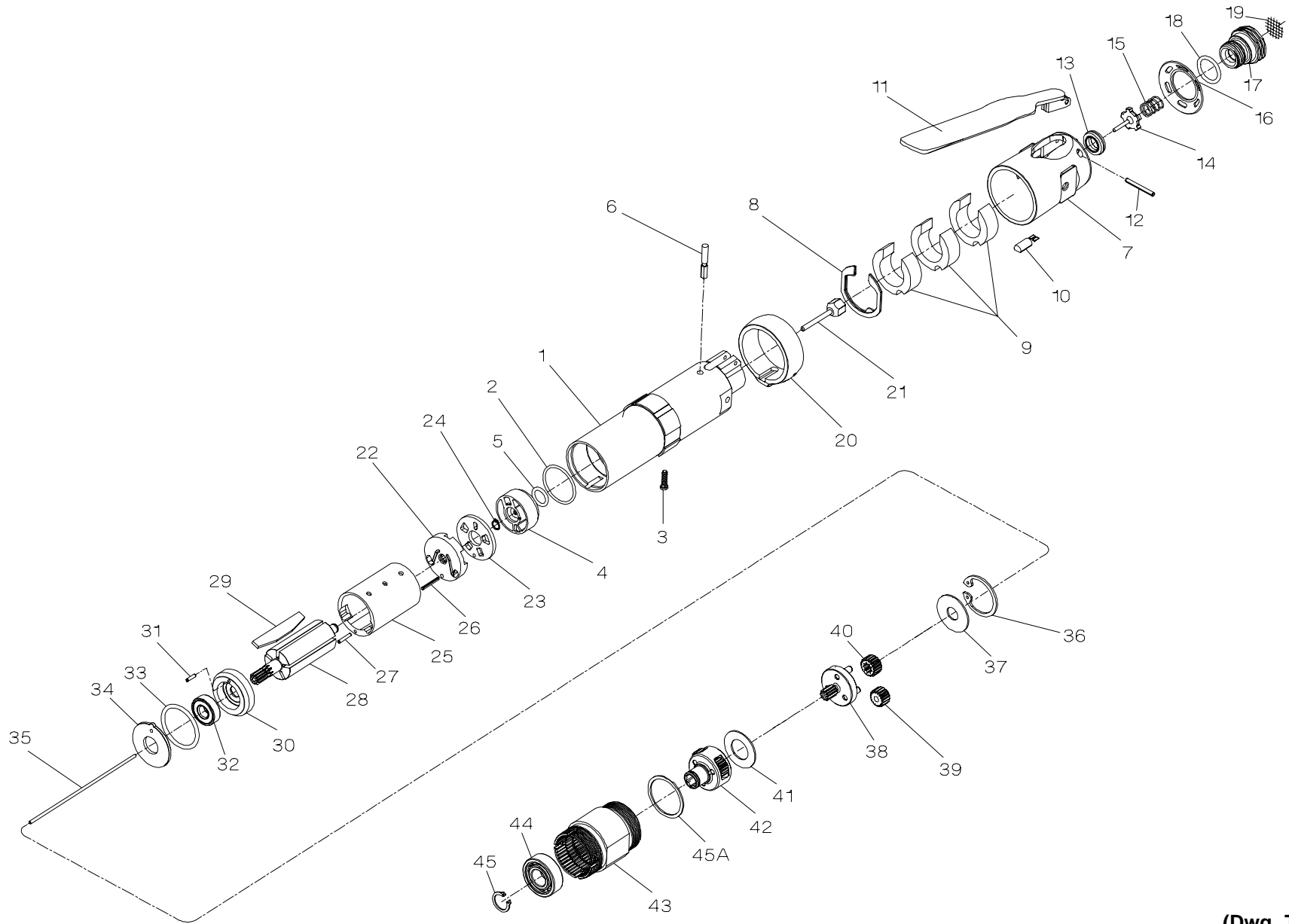

(Dwg. TPA1825)



## SERIES QA1L HIGH TORQUE ANGLE FASTENER MOTOR AND GEARING

**PART NUMBER FOR ORDERING**

**PART NUMBER FOR ORDERING**

1	Motor Housing .....	TRL-40		26	Cylinder Rear Alignment Pin .....	TRH-98
2	Housing O-ring .....	TRH-104		27	Cylinder Front Alignment Pin .....	TRH-98-1
3	Housing Screw .....	TRH-330		28	Rotor	
4	Reverse Valve Assembly				for Models with an Automatic	
	Shutoff Valve .....	TRH-A329			Shutoff Valve .....	TRH-53
	for Models without an Automatic				for Models without an Automatic	
	Shutoff Valve .....	TRH-A3291			Shutoff Valve .....	TRD-53
5	Reverse Valve Seal .....	R1A-159		29	Vane Packet (set of 5 Vanes) .....	TRH-42-5
6	Throttle Plunger .....	TRL-302		30	Front End Plate Assembly .....	TRH-A11
7	Back Cap .....	TRL-231		31	End Plate Alignment Pin .....	TRH-98-2
8	Back Cap Gasket .....	TRL-A283		32	Front Rotor Bearing .....	TRH-24
9	Muffler Element (3) .....	TRL-311		33	Motor Seal .....	TRH-211
10	Memory Chip (for models with			34	Motor Clamp Washer .....	TRH-207
	memory chip only) .....	TRH-800		35	Push Rod (for Models with an	
11	Throttle Lever .....	TRL-273			Automatic Shutoff Valve) .....	TRH-425
12	Throttle Lever Pin .....	TRL-98		36	Gear Retainer .....	TRH-28
13	Throttle Valve Seat .....	TRH-303		37	Gear Head Spacer .....	TRH-81
14	Throttle Valve .....	TRD-A302		38	Planet Gear Head Assembly (includes gear shafts)	
15	Throttle Valve Spring .....	TRL-51			for Series QA1L02 .....	TRH-A2169-16
16	Exhaust Diffuser .....	TRH-123			for Series QA1L05 .....	TRH-A2169-10
17	Inlet Bushing Assembly			39	Planet Gear (3 for each Gear Head)	
	for 1/4-18 NPT Thread .....	TRH-A465			for Series QA1L02 .....	TRH-10-16
	for 1/4-19 BSPT Thread .....	TRH-A465-B			for Series QA1L05 .....	TRH-10-10
18	Inlet Bushing Seal .....	AF120-290		40	Gear Head Pinion (for Series QA1L05 only) .....	TRH-17-21
19	Inlet Screen .....	TRH-61		41	Planet Gear Head Spacer .....	TRH-82
20	Reverse Lever .....	TRH-273		42	Rear Spindle Assembly (includes all	
21	Automatic Shutoff Valve (for all Models with				spindle gearing) .....	TRH-A8-10
	a Shutoff Clutch) .....	TRH-A435		43	Rear Gear Case .....	TAH-37
22	Rear End Plate Assembly (includes			44	Spindle Bearing .....	TRH-510
	rear rotor bearing) .....	TRH-A12-1		45	Spindle Bearing Retaining Ring .....	4E-6
23	Rear End Plate Face Plate .....	TRH-12-2		45A	Spindle Bearing Seat .....	TRH-208
24	Rear End Plate Assembly Retainer .....	8SL-305		*	Suspension Bail .....	7L-365
25	Cylinder Assembly .....	TRH-A3		*	Piped-Away Exhaust Kit (optional) .....	LG1-K284

\* Not illustrated.

# SERIES QA1L HIGH TORQUE ANGLE FASTENER CLUTCHES

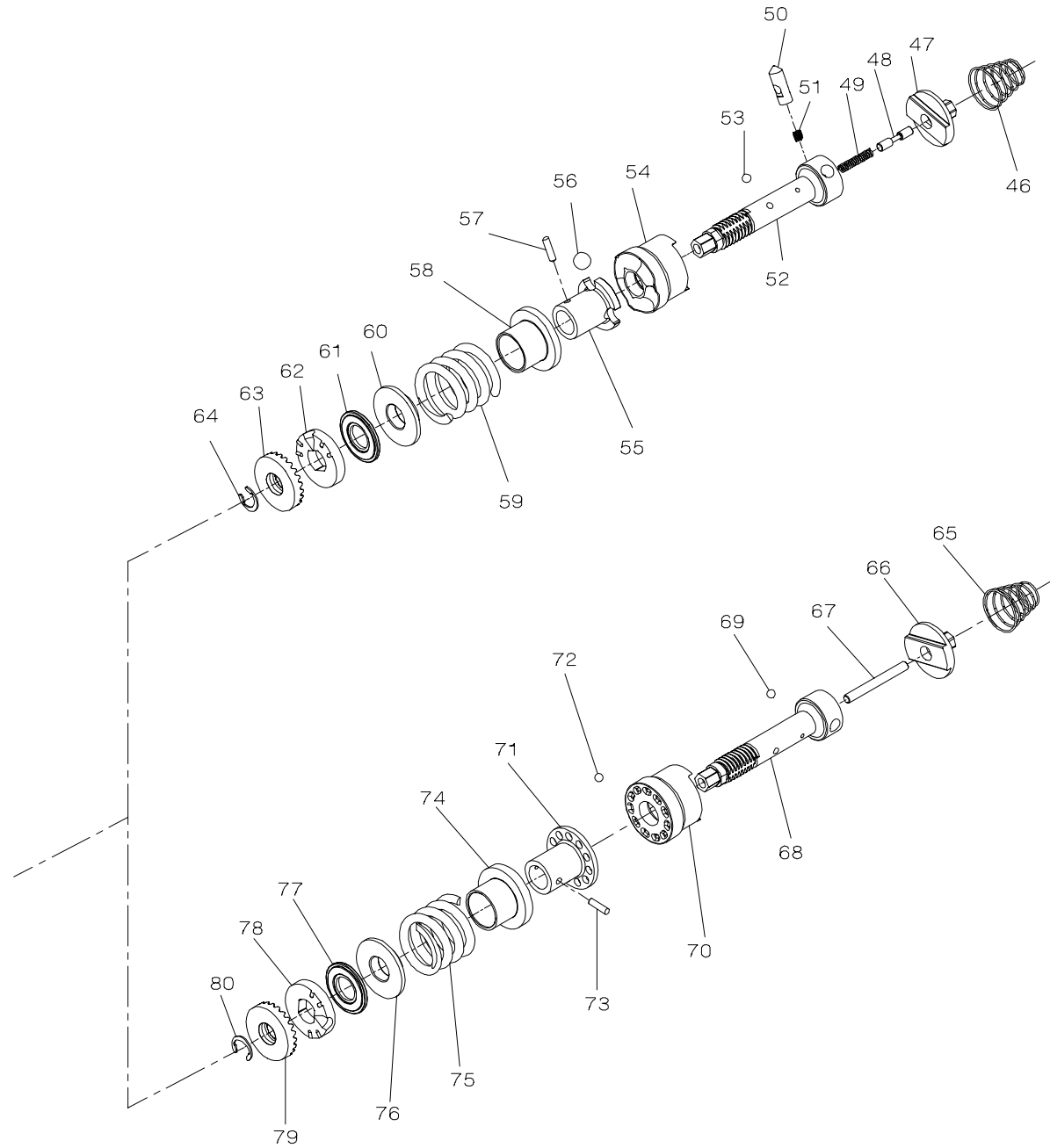



## SERIES QA1L HIGH TORQUE ANGLE FASTENER CLUTCHES

PART NUMBER FOR ORDERING

PART NUMBER FOR ORDERING

	Automatic Shutoff Clutch Assembly with medium clutch spring (standard) . . .	TRH-AM579		Cushion Clutch Assembly with medium clutch spring (standard) . . .	TRH-AM579-C
	with light clutch spring . . . . .	TRH-AL579		with light clutch spring . . . . .	TRH-AL579-C
46	Clutch Return Spring . . . . .	TRH-405	65	Clutch Return Spring . . . . .	TRH-405
47	Clutch Input Driver . . . . .	TRH-103	66	Clutch Input Driver . . . . .	TRH-103
48	Automatic Shutoff Plunger . . . . .	TRH-408	67	Clutch Pushrod . . . . .	TRH-236-C
49	Automatic Shutoff Plunger Return Spring . . . . .	TRH-420	68	Clutch Shaft . . . . .	TRH-502
50	Automatic Shutoff Pin . . . . .	TRH-704	69	Clutch Ball (1/8" diameter) (12) . . . . .	AV1-255
51	Automatic Shutoff Pin Spring . . . . .	TRH-407	70	Cam Jaw . . . . .	TRH-721-C
52	Clutch Shaft . . . . .	TRH-502	71	Clutch Cam Ball Driver . . . . .	TRH-581-C
53	Clutch Ball (1/8" diameter) (12) . . . . .	AV1-255	72	Clutch Cam Ball (1/8" diameter) (11) . . . . .	AV1-255
54	Cam Jaw . . . . .	TRH-721	73	Clutch Cam Ball Driver Retaining Pin . . . . .	TRH-188
55	Clutch Cam Ball Driver . . . . .	TRH-581	74	Cam Ball Seat . . . . .	TRH-627-C
56	Clutch Cam Ball (1/4" diameter) (3) . . . . .	4U-722	75	Clutch Spring	
57	Clutch Driver Retaining Pin . . . . .	TRH-188		medium (red) . . . . .	TRH-M583
58	Cam Ball Seat . . . . .	TRH-627		light (yellow) . . . . .	TRH-L583
59	Clutch Spring		76	Spring Seat . . . . .	TRH-623
	medium (red) . . . . .	TRH-M583	77	Thrust Bearing . . . . .	161A32-105
	light (yellow) . . . . .	TRH-L583	78	Clutch Adjusting Nut Washer . . . . .	TRH-582
60	Spring Seat . . . . .	TRH-623	79	Clutch Adjusting Nut . . . . .	TRH-588
61	Thrust Bearing . . . . .	161A32-105	80	Clutch Adjusting Nut Stop . . . . .	3S3-701
62	Clutch Adjusting Nut Washer . . . . .	TRH-582			
63	Clutch Adjusting Nut . . . . .	TRH-588			
64	Clutch Adjusting Nut Stop . . . . .	3S3-701			

**SERIES QA1L HIGH TORQUE GRIP, GEARING AND ANGLE ATTACHMENTS**

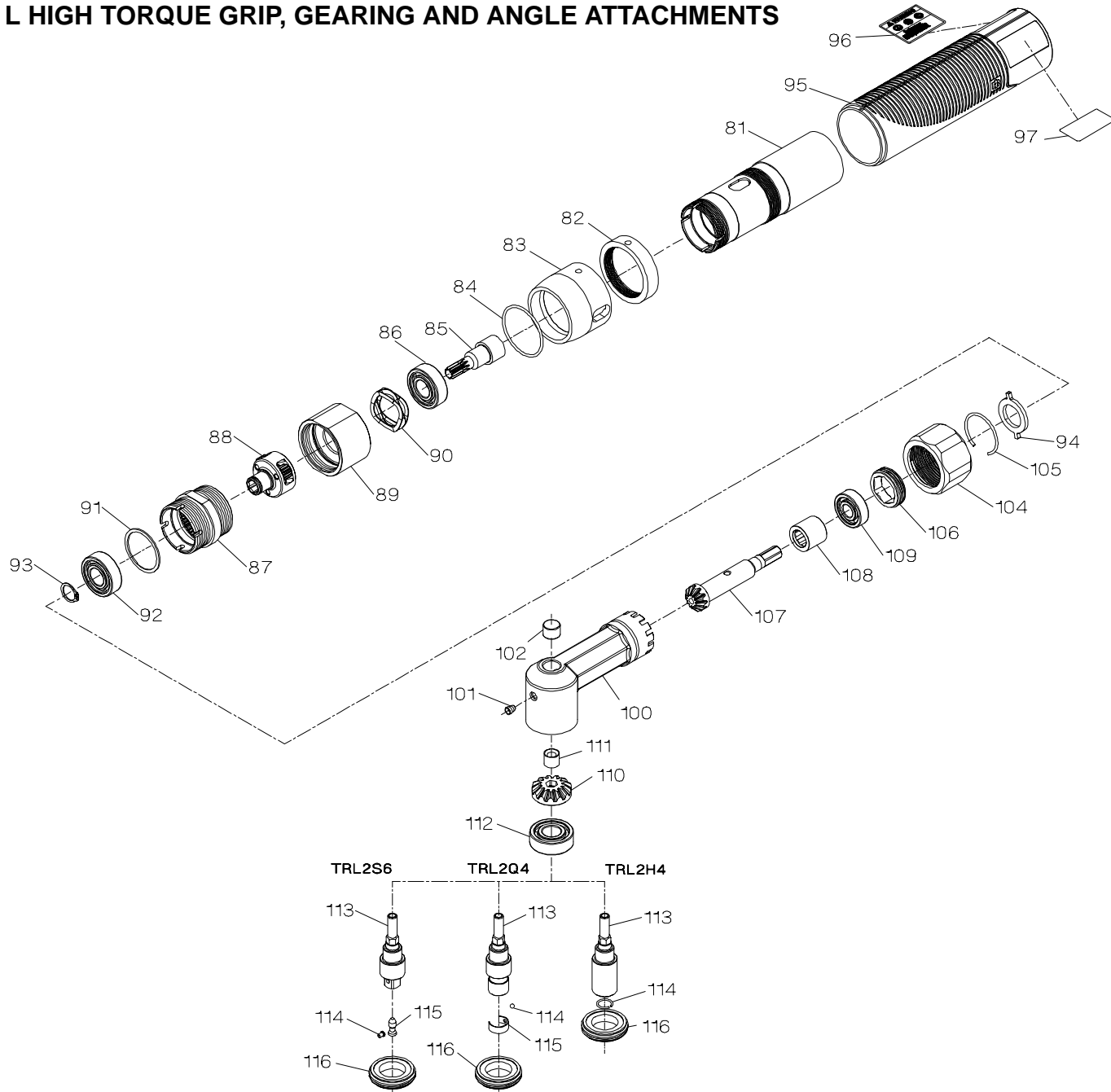



## SERIES QA1L HIGH TORQUE GRIP, GEARING AND ANGLE ATTACHMENTS

PART NUMBER FOR ORDERING



PART NUMBER FOR ORDERING



81	Clutch Housing .....	TRL-580	104	Coupling Nut .....	TRL-27
82	Grip Retaining Nut .....	TRL-40-305	105	Coupling Nut Retainer .....	TRL-29
83	Clutch Adjusting Hole Cover .....	TRL-415	106	Angle Head Plug .....	TRL1-532
84	Cover O-ring .....	TRL-415-272	107	Bevel Pinion .....	TRL2-552
85	Angle Wrench Drive Adapter .....	TRL-212	108	Pinion Front Bearing .....	H54U-511B
86	Drive Adapter Bearing .....	TRH-510	109	Pinion Rear Bearing .....	TRL-514
87	Front Gear Case .....	TAL-37-S	110	Bevel Gear .....	TRL2-551
88	Intermediate Spindle Assembly .....	TRH-A8-12	111	Bevel Gear Retainer .....	TRL2-578
89	Front Gear Case Coupler .....	TRL-304	112	Spindle Lower Bearing .....	R00B1-510
90	Thrust Washer .....	TRL-80	113	Spindle	
91	Spindle Bearing Seat .....	TRH-208		for TRL2S6 .....	TRL2-A607-S6
92	Intermediate Spindle Bearing .....	TRH-510		for TRL2Q4 .....	TRL2-A607-Q4
93	Spindle Bearing Retaining Ring .....	4E-6		for TRL2H4 .....	TRL2-A607-H4
94	Housing Lock Spacer .....	TRL-682	114	Spindle Detent	
95	Grip Assembly .....	TRH-40-A135		for TRL2S6 .....	30889
96	Nameplate .....	TRH-301		for TRL2Q4 .....	R000B-263
97	Warning Label .....	TRH-99		for TRL2H4 .....	38790
	Angle Housing Assembly		115	Detent Retainer	
	with 3/8" Square Drive .....	TRL2S6		for TRL2S6 .....	30890
	with 1/4" Quick Change .....	TRL2Q4		for TRL2Q4 .....	TRH-241
	with 1/4" Wire Detent Hex Bit Holder ..	TRL2H4	116	Lower Spindle Bearing Cap .....	120A4-531
100	Angle Housing .....	TRL2-A550	*	Spindle Bearing Cap Wrench .....	141A12-26
101	Grease Fitting .....	D0F9-879	*	Clutch Housing Spanner Wrench .....	TRH-478
102	Spindle Upper Bearing .....	TRL2-603			

\* Not illustrated.

## CLUTCH SPRING SELECTION CHART

Tool	Free Speed (rpm)	TORQUE RANGE (Soft Draw)	
		Light Clutch Spring (Yellow)	Medium Clutch Spring (Red)
All Series QA High Torque Angle Screwdrivers and Angle Wrenches	500	11.7 to 38.2 in-lbs. (1.32 to 4.32 Nm)	31.0 to 88.3 in-lbs. (3.50 to 9.98 Nm)
	250	11.7 to 38.2 in-lbs. (1.32 to 4.32 Nm)	31.0 to 88.3 in-lbs. (3.50 to 12.46 Nm)

### MAINTENANCE SECTION



**Always wear eye protection when operating or performing maintenance on this tool.**

**Always turn off the air supply and disconnect the air supply hose before installing, removing or adjusting any accessory on this tool, or before performing any maintenance on this tool.**

#### LUBRICATION

Each time a Series QA Angle Wrench or Angle Screwdriver is disassembled for maintenance and repair or replacement of parts, lubricate the tool as follows:

1. Coat all exposed gears with Ingersoll-Rand No. 67 Grease and work some of the Grease into the gearing of the Angle Housing (100).
2. Work approximately 6 to 8 cc of Ingersoll-Rand No. 28 Grease into the ball pockets, jaws, adjusting nut lock and shaft threads of the clutch mechanism.
3. Use Ingersoll-Rand No. 10 Oil to lubricate the motor. Inject approximately 1 to 2 cc of oil into the air inlet before attaching the air hose to the tool.

#### SPEED ADJUSTMENT

In addition to adjustable clutches for controlling torque, Series QA Angle Wrenches and Angle Screwdrivers are furnished with the ability to precisely control speed, within certain ranges. Setting the speed requires a tachometer. Therefore, the adjustment, although simple, should only be attempted by a competent technician using the proper equipment.

The Back Cap (7) has a small, molded stud on the end face of the Cap nearest the Exhaust Diffuser (16). That stud controls the radial location of the Diffuser which controls the opening size of the exhaust ports. Take an initial reading of the tool speed by applying a tachometer to the end of the Spindle (113). Using the procedure required to activate the motor of your particular model tool, bring the motor to maximum free speed.

After determining the actual velocity, shut off the air supply and disconnect the air line. Use a 3/4" wrench to

loosen the Inlet Bushing. The longest slot in the Exhaust Diffuser will contain the molded stud on the Back Cap. Rotate the Diffuser to open the exhaust ports to increase speed or rotate it to restrict the exhaust to reduce speed. Being careful not to allow the Diffuser to damage the molded stud, tighten the Inlet Bushing to 15 ft-lbs. (20 Nm) torque. Connect the air line and restore the air supply and check the velocity again. Determine which direction you need to rotate the Diffuser to obtain the desired speed and then rotate it accordingly. Best results are achieved by using gradual increments and frequent tachometer readings. Be sure to turn off the air supply and disconnect the line when making adjustments.

#### DISASSEMBLY

##### General Instructions

1. Do not disassemble the tool any further than necessary to replace or repair damaged parts.
2. Whenever grasping a tool or part in a vise, always use leather-covered or copper-covered vice jaws to protect the surface of the part and help prevent distortion. This is particularly true of threaded members and housings.
3. Do not remove any part which is a press fit in or on a subassembly unless the removal of that part is necessary for repairs or replacement.
4. Do not disassemble the tool unless you have a complete set of gaskets and o-rings for replacement.

##### Disassembly of the Tool

Each Series QA Angle Wrench or Angle Screwdriver is made up of modules or units. These units can be disassembled for repair or service without affecting remaining units that require no service. The same modules are not included in every model. To separate the modules, proceed as follows:

1. Lightly grasp the hex body portion of the Angle Head (100) in copper-covered or leather-covered vise jaws in a manner that provides access to the Coupling Nut (104).

## MAINTENANCE SECTION

### NOTICE

**The Coupling Nut has a left-hand thread. Rotate the Nut clockwise to loosen it.**

- Using a wrench on the flats of the Coupling Nut, loosen the Coupling Nut and then remove the tool from the vise jaws.
- With the Angle Head upward, unscrew the Coupling Nut and pull the assembled Angle Head off the front end of the tool. Remove the Housing Lock Spacer (94) from the Angle Head or the Front Gear Case (87).
- Grasp the wrench flats near the inlet end of the tool in copper-covered or leather-covered vise jaws with the clutch end upward.
- Using an adjustable wrench on the flats of the Front Gear Case Coupler (89) to prevent it from tightening, use a 1-1/16" wrench on the flats of the Front Gear Case to unscrew and separate the assembled Gear Case from the Coupler.
- Rotate the Clutch Adjusting Hole Cover (83) until the hole in the Cover is aligned with the hole in the Clutch Housing (81). Insert a rod into the opening to hold the Housing from loosening when the Coupler is removed.

### NOTICE

**The thread in the following step is a left-hand thread. Rotate the wrench clockwise to remove the Coupler.**

- Using the adjustable wrench on the flats, unscrew and remove the Coupler from the Gear Case.
- Grasp the Clutch Adjusting Hole Cover and pull it upward off the Clutch Housing. Remove the Cover O-ring (84) from inside the Cover if it needs to be replaced.

### NOTICE

**The Grip Retaining Nut has a left-hand thread. Rotate the Nut clockwise to loosen it.**

- Using a spanner wrench with a 1/8" pin, unscrew and remove the Grip Retaining Nut (82).
- Pull the Grip Assembly (95) off the Clutch Housing.
- Using pliers, pull the Angle Wrench Drive Adapter (85) with the Drive Adapter Bearing (86) and Thrust Washer (90) out of the Clutch Housing.
- Reposition the tool in the vise jaws to grasp the flats on the Gear Case with the Clutch Housing upward.

### NOTICE

**The Clutch Housing has a left-hand thread. Rotate the Housing clockwise to loosen it.**

- Engage the hook of the Clutch Housing Spanner Wrench (Part No. TRH-478) in the adjustment slot in the Gear Case and loosen the Clutch Housing.
- Remove the tool from the vise jaws and unscrew and remove the Clutch Housing, assembled clutch and Clutch return Spring (46 or 65) from the tool.
- Over a workbench, turn the gear case end of the tool downward to remove the Push Rod (35) from the power unit.
- Lightly grasp the flats of the Gear Case in leather-covered or copper-covered vise jaws with the Inlet Bushing (17) upward.
- Place a 1-3/16" open end wrench on the flats of the Back Cap (7) to prevent it from rotating, and use a 3/4" wrench to unscrew and remove the Inlet Bushing.
- Lift the Exhaust Diffuser (16) off the Back Cap.
- If the Throttle Valve Spring (15) did not come out of the tool with the Inlet Bushing, use needle nose pliers to remove it and the Throttle Valve (14) from the Motor Housing (1).
- To remove the Throttle Valve Seat (13), insert a hooked tool through the central opening of the Seat and pull it from the Motor Housing.
- Using a 1/16" pilot punch, tap the Throttle Lever Pin (12) out of the Back Cap and remove the Throttle Lever (11).
- Pull the Throttle Plunger (6) out of the Motor Housing and remove the assembly from the vise.
- Holding the assembly horizontally, remove the Back Cap, the Memory Chip (10) (if included with the tool), the Back Cap Gasket (8) and the Shutoff Valve (21) (if included with the tool).
- If the Muffler Elements (9) need to be cleaned or replaced, pull them out of the Back Cap.
- Grasp the flats at the inlet end of the Motor Housing in leather-covered or copper-covered vise jaws, and using a 1-1/16" wrench on the flats of the Motor Housing, unscrew and separate the Gear Case from the Motor Housing.
- Set the assembled Gear Case on the workbench.
- Remove the Motor Clamp Washer (34) and the Motor Seal (33) from the assembled motor in the Housing.
- Tap the Motor Housing on a wood block to remove the Motor Assembly from the Housing.



## MAINTENANCE SECTION

### Disassembly of the Angle Head

1. Slide the Coupling Nut (104) toward the output end of the Angle Head (100) and using a thin blade screwdriver, work the Coupling Nut Retaining Ring (105) out of the groove in the Angle Head. Slide the Coupling Nut off the Angle Head.
2. Using a piece of 9/16" hexagon bar stock with a 1/4" hole drilled 3/4" deep in the center to clear the hex of the Bevel Pinion (107) and a 9/16" wrench, unscrew and remove the Angle Housing Plug (106).
3. To pull the assembled Bevel Pinion out of the Angle Head, proceed as follows:
  - a) Gather together a 1/2" square drive socket for a nut larger than one inch, an 8–32 UNC socket head cap screw that is one half inch longer than the socket, a nut for the Screw and a flat washer that is larger than the socket with a hole that smaller than the nut and thick enough to withstand some pressure. A wrench for the nut and a hex wrench for the screw are also required.
  - b) Thread the nut onto the cap screw until it stops against the screw head.
  - c) To restrict the rotation of the angle head spindle, clamp a box wrench that will fit the square drive or one leg of a hex wrench that will fit into the end of the spindle opening into a vise. Insert the output end of the Spindle (113) into the wrench.
  - d) Place the square drive end of the socket against the notched end of the Angle Head.
  - e) With the cap screw and nut inserted through the flat washer, thread the cap screw through the square drive opening into the end of the Bevel Pinion until it bottoms out.
  - f) Thread the nut along the cap screw until it contacts and holds the flat washer and socket against the Angle Head.
  - g) Use a hex wrench to hold the cap screw in position while turning the nut with a wrench to jack the assembled Bevel Pinion out of the Angle Head. Unscrew the cap screw from the Bevel Pinion.
4. Slide the Pinion Rear Bearing (109) and Pinion Front Bearing (108) off the Bevel Pinion.
5. Grasp the Angle Housing lightly in copper-covered or leather-covered vise jaws with the Spindle upward.

### NOTICE

**The thread in the following step is a left-hand thread. Rotate the wrench clockwise to remove the Cap.**

6. Use the Spindle Bearing Cap Wrench (Part No. 141A12–26) to unscrew and remove the Lower Spindle Bearing Cap (116).
7. Pull the assembled Spindle out of the Angle Head.
8. Install a bearing separator between the shoulder of the Spindle and the end of the Spindle Lower Bearing (112) that is farthest from the Bevel Gear (110). Support the separator on the table of an arbor press with the output end of the Spindle downward and using a pressing plug that clears the inside of the Bevel Gear Retainer (111), press the Spindle out of the Retainer, Bevel Gear and Lower Spindle Bearing.

### NOTICE

**In the following steps, the Detent Retainer for the TRL2S6 Angle Head will most likely be damaged or destroyed during the removal process. Make certain you have a replacement available before attempting to remove it.**

9. **For TRL2S6 Angle Heads**, grasp the end of the Detent Retainer (115) with needle nose pliers and pull it from the end of the Spindle. Push the Spindle Detent (114) inward to have it fall out the end of the Spindle.  
**For TRL2Q4 Angle Heads**, use a screwdriver to pry the Detent Retainer (115) off the Spindle and remove the Spindle Detent (114) from the hole in the Spindle.  
**For TRL2H4 Angle Heads**, use a pointed probe to spiral the Spindle Detent (114) out of the internal groove in the Spindle.
10. If the Spindle Upper Bearing (102) must be replaced, press the Bearing out the end of the Angle Housing opposite the spindle end.

### Disassembly of the Adjustable Shutoff Clutch

1. Using a thin blade screwdriver, pry the Clutch Adjusting Nut Stop (64) off the end of the Clutch Shaft (52).
2. Insert the tip of a #1 Phillips Head Screwdriver into the adjustment opening between the Clutch Adjusting Nut (63) and the Clutch Adjusting Nut Washer (62). Rotate the screwdriver clockwise to thread the Adjustment Nut off the Clutch Shaft.

## MAINTENANCE SECTION

### NOTICE

**In the following step, the Clutch Cam Balls will be free to fall from the assembly when the Cam Ball Seat is moved. Make certain the Balls fall into a non-damaging container.**

3. Holding the assembly over a small pasteboard box, slide the Adjusting Nut Washer, the Thrust Bearing (61), the Spring Seat (60), the Clutch Spring (59) and the Cam Ball Seat (58) off the Clutch Shaft. Allow the three Clutch Cam Balls (56) to fall into the pasteboard box.
4. The Clutch Cam Ball Driver (55) has a cross hole that is larger on one side than the other. Insert a 1/16" drill shank or piece of wire into the smaller hole and gently push the Clutch Driver Retaining Pin (57) out of the larger hole and out of the Driver and the Clutch Shaft.

### NOTICE

**In the following step, the Clutch Balls will be free to fall from the assembly when the Cam Jaw is moved along the Clutch Shaft. Make certain the Balls fall into a non-damaging container.**

5. Holding the assembly over a small pasteboard box, and using care to drop the twelve Clutch Balls (53) into the box, slide the Clutch Cam Ball Driver and Cam Jaw (54) off the Clutch Shaft. If grease held some of the Balls inside the jaw cavity, remove them.
6. With the large end of the Clutch Shaft downward, depress the Automatic Shutoff Pin (50) with varying amounts of finger pressure while tapping the large end edge of the Clutch Shaft on a piece of wood until the Automatic Shutoff Plunger (48) protrudes slightly from the end of the Shaft. Grasp the Plunger and carefully pull it out of the Clutch Shaft.
7. Remove the Automatic Shutoff Pin and Automatic Shutoff Pin Spring (51) from the Clutch Shaft. The Pin Spring should remain in the pin recess when the Pin is removed. To separate the Spring from the Pin, gently rotate the Spring while pulling it from the recess to avoid elongating the Spring.
8. Using a hooked tool, reach into the opening in the end of the Clutch Shaft and carefully pull the Automatic Shutoff Plunger Return Spring (49) out of the Shaft without elongating the Spring.

### Disassembly of the Adjustable Cushion Clutch

1. Using a thin blade screwdriver, pry the Clutch Adjusting Nut Stop (80) off the end of the Clutch Shaft (68).

2. Insert the tip of a #1 Phillips Head Screwdriver into the adjustment opening between the Clutch Adjusting Nut (79) and the Clutch Adjusting Nut Washer (78). Rotate the screwdriver clockwise to thread the Adjustment Nut off the Clutch Shaft.

### NOTICE

**In the following step, the Clutch Cam Balls will be free to fall from the assembly when the Cam Ball Seat is moved. Make certain the Balls fall into a non-damaging container.**

3. Holding the assembly over a small pasteboard box, slide the Adjusting Nut Washer, the Thrust Bearing (77), the Spring Seat (76), the Clutch Spring (75) and the Cam Ball Seat (74) off the Clutch Shaft. Allow the eleven Clutch Cam Balls (72) to fall into the pasteboard box.
4. The Clutch Cam Ball Driver (71) has a cross hole that is larger on one side than the other. Insert a 1/16" drill shank or piece of wire into the smaller hole and gently push the Clutch Driver Retaining Pin (73) out of the larger hole and out of the Driver and the Clutch Shaft.

### NOTICE

**In the following step, the Clutch Balls will be free to fall from the assembly when the Cam Jaw is moved along the Clutch Shaft. Make certain the Balls fall into a non-damaging container.**

5. Holding the assembly over a small pasteboard box, and using care to drop the twelve Clutch Balls (69) into the box, slide the Clutch Cam Ball Driver and Cam Jaw (70) off the Clutch Shaft. If grease held some of the Balls inside the jaw cavity, remove them.

### Disassembly of the Gearing

1. Using snap ring pliers, remove the Gear Retainer (36) from the motor end of the Rear Gear Case (43) and remove the Gear Head Spacer (37) as well.
2. **For Series QA1L02**, lightly rap the motor end of the Rear Gear Case on a wooden work bench top to remove the three Planet Gears (39), the Planet Gear Head Assembly (38) and the Planet Gear Head Spacer (41).  
**For Series QA1L05**, lightly rap the motor end of the Rear Gear Case on a wooden work bench top to remove the three Planet Gears (39), The Gear Head Pinion (40), the Planet Gear Head Assembly (38) and the Planet Gear Head Spacer (41).
3. Using snap ring pliers, remove the Spindle Bearing Retaining Ring (45 or 93).

## MAINTENANCE SECTION

- Stand the Rear Gear Case or the Front Gear Case (87) on the table of an arbor press with the output spindle upward. Using a rod that neatly fits inside the internal hex of the Spindle (42 or 88), press the Rear Spindle Assembly out of the Spindle Bearing (44) or the Intermediate Spindle Assembly out of the Intermediate Spindle Bearing (92).

### CAUTION

**Do not remove the Bearing in the following step unless you have a new replacement available for installation. The Bearing will be damaged by the removal process.**

- Invert either Gear Case on the table of an arbor press so that the end face having four notches makes contact with the table. Using a rod against the inner race of the Rear or Intermediate Spindle Bearing, press the Bearing from the Gear Case.
- If the Spindle Bearing Seat (45A or 91) must be replaced, use a small, thin blade screwdriver to spiral it out of the groove in the Gear Case.

### Disassembly of the Motor

- Using snap ring pliers, remove the Rear End Plate Assembly Retainer (24) from the shaft of the Rotor (28).
- Pull the Rear End Plate Face Plate (23) and Rear End Plate Assembly (22) off the hub of the Rotor.
- Lift the Cylinder (25) from the Rotor.
- Remove the Vanes (29) from the Rotor.
- Support the Front End Plate Assembly (30), as near the rotor body as possible, on the table of an arbor press and press the Rotor from the Front Rotor Bearing (32). Remove the Bearing from the Front End Plate.

### Disassembly of the Housing

- Pull the Reverse Lever (20) off the inlet end of the Motor Housing (1).
- Using a #2 Phillips Head Screwdriver, unscrew and remove the Housing Screw (3).
- Insert a 5/16" wooden dowel between 6 and 8 inches long, into the inlet end of the Motor Housing and push the Reverse Valve Assembly (4) out the motor end of the Housing.
- Use a hooked tool to pull the Housing O-ring (2) out of the Motor Housing.

## ASSEMBLY

### General Instructions

- Always press on the **inner** ring of a ball-type bearing when installing the bearing on a shaft.
- Always press on the **outer** ring of a ball-type bearing when pressing the bearing into a bearing recess.

- Whenever grasping a tool or part in a vise, always use leather-covered or copper-covered vise jaws to protect the surface of the part and help prevent distortion. This is particularly true of threaded members and housings.
- Except for bearings, always clean every part and wipe every part with a thin film of oil before installation.
- Apply o-ring lubricant to all o-rings before final assembly.
- Check every bearing for roughness. If an open bearing must be cleaned, wash it thoroughly in a clean, suitable cleaning solution and dry with a clean cloth. **Sealed or shielded bearings should never be cleaned.** Work grease into every open bearing before installation.

### Assembly of the Housing

- Lubricate the Housing O-ring (2) with o-ring lubricant and install it at the bottom of the cylinder bore in the Motor Housing (1).
- Inspect the face of the Reverse Valve Assembly (4) and Reverse Valve Seal (5) for nicks or damage. Replace the Reverse Valve Assembly or Seal if any damage is evident.
- Lubricate the Seal on the hub of the Reverse Valve Assembly with o-ring lubricant and insert the Assembly, Seal end leading, into the cylinder bore of the Motor Housing. Push the Assembly toward the bottom of the cylinder bore until it "snaps" into its proper location.
- Rotate the Valve inside the Housing until the threaded hole into the side of the Valve for the Motor Housing Screw (3) aligns with the hole in the Motor Housing.
- Using a #2 Phillips Head Screwdriver, thread the Motor Housing Screw into the Reverse Valve Assembly through the Housing until the underside of the screw head stops against the Housing. Back the Screw out of the Valve between 1/4 and 1/2 turn.
- Align the open end of the slot inside the Reverse Lever (20) with the head of the Housing Screw. From the inlet end of the Housing, slide the Lever onto the Housing, making certain the screw head enters the slot, and move it along the Housing until it stops against the housing shoulder.
- Rotate the Lever to make certain the Valve only has slight resistance.

### Assembly of the Motor

- Place the Front End Plate (30) on the splined shaft of the Rotor (28) with the bearing recess away from the rotor body.
- Place the Front Rotor Bearing (32) onto the shaft and using a sleeve or piece of tubing that contacts the inner race of the Bearing, press the Bearing onto the shaft until the Front End Plate nearly contacts the rotor body.

## MAINTENANCE SECTION

### NOTICE

**In the following step, the measurement must be made at the end corner of the large rotor body.**

- The clearance between the Front End Plate and Rotor is critical. While pressing down with your finger on the outer edge of the Front End Plate on the bearing side, insert a 0.004" (0.1 mm) feeler gauge between the face of the rotor body and the face of the End Plate at a point that is 180 degrees from where the pressure is applied. Refer to Dwg. TPA1740. To increase the gap, support the End Plate and lightly tap the rotor shaft with a plastic hammer; to decrease the gap, press the Bearing farther onto the rotor shaft.

#### Measurement of Front End Plate Clearance

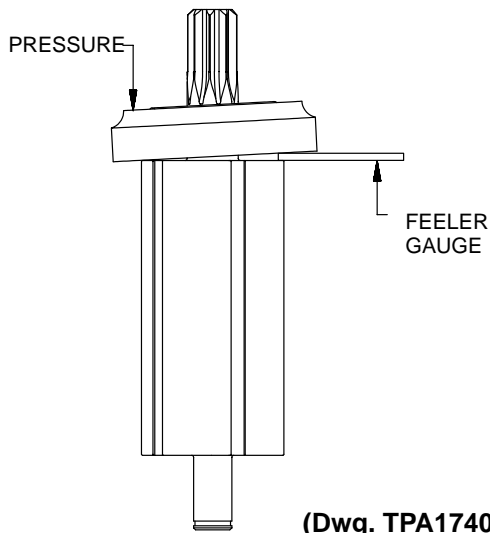

- Wipe each Vane (29) with a light film of Ingersoll-Rand No.10 Oil and place a Vane in each slot in the Rotor.
- One end of the Cylinder Assembly (25) has a notch that breaks the outer wall and end face of the Cylinder. With that end trailing, install the Cylinder Assembly over the Rotor and Vanes against the Front End Plate. Make certain the Cylinder Front Alignment Pin (27) enters the hole in the Front End Plate.
- Install the Rear End Plate Assembly (22), flat face leading, on the rear hub of the Rotor. Make certain the Cylinder Rear Alignment Pin (26) enters the hole in the Rear End Plate.
- Examine the Rear End Plate Face Plate (23) for scratches. If it is scratched, replace it. If it is not, slide it onto the rear hub of the Rotor and onto the Cylinder Rear Alignment Pin against the Rear End Plate. Some pressure may be required to fit the hole in the Plate onto the Alignment Pin.

- Using snap ring pliers, install the Rear End Plate Assembly Retainer (24) in the annular groove on the rear rotor hub to secure the assembly in position.
- Set the assembled motor aside.

#### Assembly of the Rear Gear Case

- Using a small screwdriver, work the Spindle Bearing Seat (45A) into the internal groove nearest the notched end of the Rear Gear Case (43).
- Stand the Rear Gear Case, notched end upward, on the table of an arbor press. Using a piece of tubing that contacts the outer race of the Spindle Bearing (44), press a new Bearing into the Gear Case against the Seat.
- Lubricate the gears in the Rear Spindle Assembly (42) with Ingersoll-Rand No. 67 Grease.
- Invert the Rear Gear Case and using another piece of tubing that supports the inner race of the Bearing and clears the output end of the Spindle Assembly, press the Rear Spindle Assembly into the Bearing from the motor end of the Rear Gear Case.
- Using snap ring pliers, install the Spindle Bearing Retaining Ring (45) in the external groove near the driver end of the spindle.
- Lightly lubricate the Planet Gear Head Spacer (41) with Ingersoll-Rand No. 67 Grease and install it in the Rear Gear Case against the Spindle Assembly.
- Lubricate the shafts of the Planet Gear Head Assembly (38) with Ingersoll-Rand No. 67 Grease and install the Gear Head in the Rear Gear Case meshing the spline on the shaft with the gear teeth in the Spindle Assembly.
- For Series QA1L02**, lubricate the Planet Gears (39) with Ingersoll-Rand No. 67 Grease and install them on the shafts of the Planet Gear Frame Assembly. **For Series QA1L05**, lubricate the Planet Gears (39) and Gear Head Pinion (40) with Ingersoll-Rand No. 67 Grease and install the Planet Gears on the shafts of the Planet Gear Frame Assembly. Insert the Gear Head Pinion in the center of the Planet Gears making certain the teeth mesh.
- Install the Gear Head Spacer (37) against the Gears and secure the assembly by using snap ring pliers to install the Gear Retainer (36) in the internal groove at the motor end of the Rear Gear Case.

#### Assembly of the Adjustable Cushion Clutch

- Insert the small end of the Clutch Shaft (68) into the end of the Cam Jaw (70) having the large opening and slide the Shaft about half way into the Jaw.
- Drop the twelve Clutch Balls (69) into the Cam Jaw forming a ring around the Clutch Shaft.

## MAINTENANCE SECTION

3. Lay a bead of Ingersoll–Rand No. 28 Grease, approximately 2 to 3 cc, on top of the Clutch Balls and then bring the Clutch Shaft and Cam Jaw together capturing the Balls between them.
4. While holding the Shaft and Jaw together, slide the Clutch Cam Ball Driver (71), large end leading, onto the Clutch Shaft until it is against the Cam Jaw.
5. Rotate the Driver to align the large hole through one wall of the Driver with the comparable size opening of the cross hole through the Clutch Shaft. Push the Clutch Cam Ball Driver Retaining Pin (73) into the hole to lock the Driver in position on the Clutch Shaft.
6. Apply a coating of Ingersoll–Rand No. 28 Grease to each of the eleven Clutch Cam Balls (72).
7. Holding the assembled Clutch Shaft with the Clutch Cam Ball Driver upward, insert a lubricated Ball into each of the eleven ball pockets in the Driver.
8. Slide the Cam Ball Seat (74), large end leading, onto the Shaft against the Balls. Follow with the Clutch Spring (75), Spring Seat (76), Thrust Bearing (77) and the Clutch Adjusting Nut Washer (78) with the smooth face leading.
9. Thread the Clutch Adjusting Nut (79), smooth face trailing, onto the Clutch Shaft.
10. Insert the tip of a #1 Phillips Head Screwdriver into the adjustment opening between the Clutch Adjusting Nut and the Clutch Adjusting Nut Washer. Rotate the screwdriver counterclockwise and thread the Adjustment Nut onto the Clutch Shaft until the external groove for the Clutch Adjusting Nut Stop (80) is visible.
11. Install the Nut Stop in the groove.

### Assembly of the Adjustable Shutoff Clutch

1. Hold the Clutch Shaft (52) in your hand with the large end upward.
2. Insert the Automatic Shutoff Plunger Return Spring (49) into the central opening in the large end of the Clutch Shaft. Use a 1/8" dowel to push the Spring below the cross hole for the Automatic Shutoff Pin (50).
3. Insert the Automatic Shutoff Pin Spring (51) in the end hole of the Automatic Shutoff Pin opposite the pointed end. Rotate the Spring a little to keep it in the hole.
4. Drip one or two drops of Ingersoll–Rand No. 10 Oil into the central hole with the Plunger Return Spring.
5. Position the Shutoff Pin, Spring leading, in the cross hole on the large end of the Clutch Shaft with the hole in the Shutoff Pin aligned with the central hole containing the Return Spring.
6. Push on the pointed end of the Shutoff Pin to depress the Spring while inserting the Automatic Shutoff Plunger (48) into the central opening with the Return

Spring. The smaller center portion of the Shutoff Plunger will allow the Shutoff Pin to spring outward and capture the components within the Clutch Shaft when properly positioned.

7. Insert the small end of the Clutch Shaft into the end of the Cam Jaw (54) having the large opening and slide the Shaft about half way into the Jaw.
8. Drop the twelve Clutch Balls (53) into the Cam Jaw forming a ring around the Clutch Shaft.
9. Lay a bead of Ingersoll–Rand No. 28 Grease, approximately 2 to 3 cc, on top of the Clutch Balls and then bring the Clutch Shaft and Cam Jaw together capturing the Balls between them.
10. While holding the Shaft and Jaw together, slide the Clutch Cam Ball Driver (55), large end leading, onto the Clutch Shaft until it is against the Cam Jaw.
11. Rotate the Driver to align the large hole through one wall of the Driver with the comparable size opening of the cross hole through the Clutch Shaft. Push the Clutch Cam Ball Driver Retaining Pin (57) into the hole to lock the Driver in position on the Clutch Shaft.
12. Apply a coating of Ingersoll–Rand No. 28 Grease to each of the three Clutch Cam Balls (56).
13. Holding the assembled Clutch Shaft with the Clutch Cam Ball Driver upward, insert a lubricated Ball into each of the three ball slots in the Driver.
14. Slide the Cam Ball Seat (58), large end leading, onto the Shaft against the Balls. Follow with the Clutch Spring (59), Spring Seat (60), Thrust Bearing (61) and the Clutch Adjusting Nut Washer (62) with the smooth face leading.
15. Thread the Clutch Adjusting Nut (63), smooth face trailing, onto the Clutch Shaft.
16. Insert the tip of a #1 Phillips Head Screwdriver into the adjustment opening between the Clutch Adjusting Nut and the Clutch Adjusting Nut Washer. Rotate the screwdriver counterclockwise and thread the Adjustment Nut onto the Clutch Shaft until the external groove for the Clutch Adjusting Nut Stop (64) is visible.
17. Install the Nut Stop in the groove.

### Assembly of the Front Gear Case

1. Using a small screwdriver, work the Spindle Bearing Seat (91) into the internal groove nearest the notched end of the Front Gear Case (87).
2. Stand the Front Gear Case, notched end upward, on the table of an arbor press. Using a piece of tubing that contacts the outer race of the Intermediate Spindle Bearing (92), press a new Bearing into the Front Gear Case against the Seat.
3. Lubricate the gears in the Intermediate Spindle Assembly (88) with Ingersoll–Rand No. 67 Grease.

## MAINTENANCE SECTION

4. Invert the Front Gear Case and using another piece of tubing that supports the inner race of the Bearing and clears the output end of the Spindle Assembly, press the Intermediate Spindle Assembly into the Bearing from the clutch end of the Front Gear Case.
5. Using snap ring pliers, install the Spindle Bearing Retaining Ring (93) in the external groove near the angle head end of the spindle.

### Assembly of the Angle Head

1. If the Spindle Upper Bearing (102) was removed, stand the output end of the Angle Head (100) on the table of an arbor press. Pressing against the closed end of a new Bearing, press the Bearing into the small opening until the trailing end is flush with the outside surface of the Angle Head.
2. Apply a light film of Ingersoll–Rand No. 67 Grease to the shaft of the Bevel Pinion (107) and to the inside of the Pinion Front Bearing (108).
3. Slide the Pinion Front Bearing, stamped end trailing, onto the shaft until it stops against the back of the gear.
4. Without distorting the Angle Head, support the hex flats of the Angle Head in a machine vise on the table of an arbor press with the notched end upward and the Head resting on a solid stop. Apply 2 to 4 cc of Ingersoll–Rand No.67 Grease to the gear on the end of the Bevel Pinion.
5. Insert the gear end of the Bevel Pinion into the notched end of the Angle Head while aligning the Pinion Front Bearing with the central opening.
6. Use a piece of tubing that clears the shaft of the Bevel Pinion and the inner wall of the Angle Head and press the Bearing into the Angle Head against the stop.
7. Apply some Ingersoll–Rand No. 67 Grease to the Pinion Rear Bearing (109) and slide it onto the shaft of the Bevel Pinion and into the Angle Head recess.
8. Use the 9/16” hex stock with clearance for the bevel pinion shaft that was used during disassembly to screw the Angle Head Plug (106) into the Angle Head against Pinion Rear Bearing. Tighten the Plug between 8 and 12 ft–lbs. (10.8 and 16.2 Nm) torque.
9. Remove the assembly from the machine vise and position it in leather–covered or copper–covered vise jaws with the opening for the output spindle upward.
10. Stand the Spindle (113) on the table of an arbor press and using a piece of tubing that clears the shaft of the Spindle and contacts the inner ring of the Spindle Lower Bearing (112), press the Bearing onto the shaft of the Spindle until it stops against the shoulder.
11. In the same manner, press the Bevel Gear (110), flat end leading, onto the hex portion of the spindle shaft. Likewise, press the Bevel Gear Retainer (111) onto the spindle shaft until it stops against the gear face.

12. Insert the assembled Spindle, output end trailing, into the Angle Head.

### NOTICE

**The thread in the following step is a left–hand thread. Rotate the wrench counterclockwise to tighten the Cap.**

13. Thread the Lower Spindle Bearing Cap (116) into the Angle Head and using the Spindle Bearing Cap Wrench (Part No. 141A12–26), tighten the Cap between 8 and 12 ft–lbs. (10.8 and 16.2 Nm) torque.
14. **For TRL2S6 Angle Heads**, install the Spindle Detent (114) into position through the end of the Spindle and push the Detent Retainer (115), tapered end leading, into the end of the Spindle.  
**For TRL2Q4 Angle Heads**, place the Spindle Detent (114) into the hole in the groove of the Spindle. Spread the Detent Retainer (115) and install it on the Spindle to capture the Detent.  
**For TRL2H4 Angle Heads**, install the Spindle Detent (114) in the internal groove in the Spindle
15. Remove the assembly from the vise jaws and slide the Coupling Nut (104), threaded end trailing, onto the notched end of the Angle Head. Move the Nut far enough onto the housing to install the Coupling Nut Retainer (105) in the annular groove at the notched end of the Angle Head.

### Assembly of the Tool

1. Lightly grasp the flats at the inlet end of the Motor Housing (1) in leather–covered or copper–covered vise jaws with the motor bore upward.
2. Grasp the spline of the Rotor (28) in the assembled motor and after aligning the End Plate Alignment Pin (31) with the internal notch in the motor end of the housing bore, insert the assembled motor into the Motor Housing. Make certain the motor is far enough into the Housing to have the undercut below the internal housing thread visible.
3. Lubricate the Motor Seal (33) with o–ring lubricant and install it around the Front End Plate (30) and into the undercut in the Housing.
4. Align the tab of the Motor Clamp Washer (34) with the internal notch in the Housing and install it over the rotor hub and End Plate Alignment Pin against the Motor Seal. Make certain the Pin enters the hole in the Washer and the Washer is flat against the Seal.
5. Apply some Ingersoll–Rand No. 67 Grease to the spline on the rotor shaft.
6. Thread the assembled Rear Gear Case (43), output spindle trailing, into the Motor Housing and using a 1–1/16” wrench, tighten the joint between 15 and 20 ft–lbs. (20 and 27 Nm) torque.

## MAINTENANCE SECTION

- Place the narrow end of the Clutch Return Spring (46 or 65) in the Rear Gear Case against the inner race of the Spindle Bearing (44).
- Place the hex drive end of the Clutch Input Driver (47 or 66) on the Spring and compress the Spring until the hex on the Driver enters the hex recess in the Spindle Assembly (42). While holding the Driver in position, engage the raised bar on the face of the Driver with the jaw of the Cam Jaw (54 or 70).

### NOTICE

**The following step has parts with a left-hand thread. Rotate the components counterclockwise to tighten them.**

- Install the Clutch Housing (81) over the clutch components and thread it onto the Rear Gear Case. Using a 1-1/16" wrench on the flats of the Rear Gear Case and the Clutch Housing Spanner Wrench (Part No. TRH-478) in the clutch housing slot, tighten the joint between 15 and 20 ft-lbs. (20 and 27 Nm) torque.
- Invert the assembled tool in the vise jaws and lightly grasp the flats on the Rear Gear Case with the inlet end of the tool upward.
- Insert a 5/8" dowel through the opening in the Back Cap (7), and using the dowel as an alignment device, install the three Muffler Elements (9) in the cavity of the Back Cap. Make certain the notches in the outer edge of the Elements fit over the memory chip pocket in the bottom of the Cap.
- If the tool is equipped with a Memory Chip (10), install it (with the leads entering first) in the pocket at the bottom of the Back Cap.
- Make certain the tab on the inside edge of the Back Cap Gasket (8) is aligned with the pocket for the Memory Chip and install the Gasket, metal face leading, in the recess of the Back Cap against the face with the cavity containing the Muffler Elements.
- Position the gasket end of the alignment dowel against the inlet hub on the Motor Housing. Align the flats on the Cap with the flats on the Housing. Orient the Back Cap and slide the Back Cap Assembly off the alignment dowel and onto the Motor Housing.
- For all Models with a Shutoff Clutch**, install the Push Rod (35) into the central hole in the inlet hub. The Rod will enter the assembled motor and disappear from view when released. Install the Shutoff Valve (21), small end first, in the same opening.
- Being careful not to damage it, insert the Throttle Valve Seat (13) into the central opening at the inlet end of the Motor Housing at an angle until it clears the threads in the Housing. Using a rod with a flat end and no sharp edges, push the Seat to the bottom of the opening until it seats flush.
- Using needle nose pliers, insert the Throttle Valve (14), long stem leading, into the opening against the Seat. Center the Valve in the Seat.
- Install the Throttle Valve Spring (15) in the opening so that it encircles the Valve.
- The Exhaust Diffuser (16) has one slot that is longer than the other five slots. The Back Cap has a short, molded stud projecting from the inlet end. Place the Exhaust Diffuser against the Back Cap with the long slot encircling the molded stud. Rotate the Diffuser counterclockwise until the wall of the slot stops against the stud. The exhaust ports are now in the full open position which will provide maximum free speed.
- If the Inlet Screen (19) required replacement, use a wooden dowel to carefully push a new one into the Inlet Bushing (17).
- If the Inlet Bushing Seal (18) is nicked or damaged, carefully install a new one over the threads of the Inlet Bushing.
- Thread the Inlet Bushing Assembly through the Diffuser and Back Cap into the Motor Housing. Using a 1-3/16" wrench on the flats of the Back Cap to keep it from turning, tighten the Inlet Bushing between 15 and 20 ft-lbs. (20 and 27 Nm) torque.
- The Throttle Plunger (6) has a lengthwise flat on the outer edge at one end of the Plunger. Insert the Plunger, flat end first, into the cross hole in the Housing. Push on the end of the Plunger to make certain it springs back from contact with the stem of the Throttle Valve.
- Position the Throttle Lever (11) in the slot in the Back Cap and Motor Housing and using a 1/16" diameter rod, align the holes through the Back Cap, Motor Housing and Throttle Lever. While maintaining alignment, install the Throttle Lever Pin (12) in place of the rod by tapping it through all three pieces.
- Remove the tool from the vise jaws and install the Grip Assembly (95), internal slotted end leading, over the Clutch Housing and Rear Gear Case. Engage the slots in the Grip Assembly with the notches on the Motor Housing (1).

## MAINTENANCE SECTION

### NOTICE

**The thread in the following step is a left-hand thread. Rotate the Nut counterclockwise to tighten it.**

26. Thread the Grip Retaining Nut (82) onto the Clutch Housing to secure the Grip Assembly. Use a pin type spanner wrench to tighten it until the Grip is not loose.
27. If the Cover O-ring (84) inside the Clutch Adjusting Hole Cover (83) is worn or damaged, replace it and install the Cover on the Clutch Housing.
28. Install the large end of the Angle Wrench Drive Adapter (85) on the hex end of the Clutch Shaft (52 or 68).
29. Slide the Drive Adapter Bearing (86) onto the small end of the Adapter and into the bearing recess in the Clutch Housing.
30. Place the Thrust Washer (90) against the Drive Adapter Bearing.

### NOTICE

**The thread in the following step is a left-hand thread. Rotate the Coupler counterclockwise to tighten it.**

31. Thread the Front Gear Case Coupler (89) onto the Clutch Housing and tighten the joint between 15 and 20 ft-lbs. (20 and 27 Nm) torque.
32. Engage the spline of the Drive Adapter with the internal gears of the Intermediate Spindle Assembly (88) while threading the assembled Front Gear Case (87) into the Coupler. Tighten the joint between 15 and 20 ft-lbs. (20 and 27 Nm) torque.
33. Position the Housing Lock Spacer (94) in the Front Gear Case with the tabs of the Spacer going into the notch openings.

### NOTICE

**The thread in the following step has a left-hand thread. Rotate the Nut counterclockwise to tighten it.**

34. Orient the assembled Angle Head to the desired position and insert the notched end of the Angle Head into the Front Gear Case to engage the tabs of the Spacer. While compressing the Clutch Return Spring (46 or 65) with the Angle Head, thread the Coupling Nut (104) onto the Front Gear Case and tighten it between 2 and 5 ft-lbs. (2.7 and 6.8 Nm) torque.

### TESTING THE TOOL

Before placing the tool back in service, test the tool in a run down application to determine if adjustments are necessary to satisfactorily perform the operation. Since a number of interrelated adjustments can affect tool performance, only experience, along with trial and error, can dictate which adjustment or combination of adjustments will provide the desired results.

The Clutch Spring (59 or 75), the clutch adjustment procedure, the exhaust flow, the length of the Push Rod (35) and the length of the Shutoff Valve (21) can individually or collectively have an effect on torque and/or speed. Always try to make adjustments before replacing or attempting to modify components.

If adjustments are unable to provide the desired torque, it may be necessary to install a lighter or heavier Clutch Spring.

If the tool ratchets when operated but fails to shutoff, it may be necessary to shorten the Push Rod. Only shorten the Push Rod in small increments. Increments between 0.005" and 0.010" (0.13 and 0.25 mm) are recommended.

If the tool stalls and does not shutoff, runs slower than normal or has low power, the Shutoff Valve may require lengthening. To lengthen the Shutoff Valve, grasp the stem between two pieces of rubber or other non-slip, non-marring material and rotate the molded nut counterclockwise. Rotating the nut one half revolution will lengthen the Valve approximately 0.009" (0.23 mm).

**Should the stem of the Valve become bent, marred, nicked or damaged in any way during the adjustment process, replace it.**



## TROUBLESHOOTING GUIDE

Trouble	Probable Cause	Solution
Loss of Power	Low air pressure	Check air supply. For top performance, the air pressure must be 90 psig (6.2 bar/620 kPa) at the inlet.
	Plugged Inlet Bushing Screen	Clean the Inlet Bushing Screen using a clean, suitable cleaning solution. If the Screen cannot be cleaned, replace it.
	Worn or broken Vanes	Replace a <b>complete</b> set of Vanes.
	Worn or broken Cylinder	Replace the Cylinder if it is cracked or if the bore appears wavy or scored.
	Exhaust control restricted	Make certain the Exhaust Diffuser against the Back Cap is in the fully open position.
	Shutoff Valve too short	Lengthen the Shutoff Valve. Refer to <b>TESTING THE TOOL</b> on page 32.
Motor won't run	Motor Clamp Washer binding	Remove the Gear Case make certain the Washer is flat and the Motor Seal is properly positioned.
	Gears binding	Clean and inspect all gearing. Replace any worn or damaged gearing.
	Push Rod worn	Install a new Push Rod.
Gear Case gets hot	Excessive grease	Clean and inspect Gear Case and gearing parts and lubricate as instructed.
	Worn or damaged parts	Clean and inspect the gear Case and Gearing. Replace worn or broken components.
Inconsistent disengagement of the Adjustable Clutch	Improper lubrication	Remove the Adjustable Clutch mechanism and examine the parts. Lubricate as instructed.
	Wrong Clutch Spring (using Heavy Clutch Spring on light torque application)	Change to Medium or Light Clutch Spring.
Motor stalls before Adjustable Clutch ratchets	Improper Clutch adjustment or improper tool ratio for application	Check Clutch Adjustment and review tool performance vs. requirements.
	Low pressure at the inlet	Check the air supply. For top performance, the air pressure must be 90 psig (6.2bar/620kPa) at the inlet.
	Insufficient grease	Lubricate the Clutch as instructed.
	Improper exhaust control adjustment	Adjust the exhaust flow to obtain the desired speed.
Tool ratchets before shutoff	Push Rod too long	Shorten the push Rod. Refer to <b>TESTING THE TOOL</b> on page 32.
Tool stalls without shutting off	Shutoff Valve too short	Lengthen the Shutoff Valve. Refer to <b>TESTING THE TOOL</b> on page 32.
Too runs slower than normal	Shutoff Valve too short	Lengthen the Shutoff Valve. Refer to <b>TESTING THE TOOL</b> on page 32.

### NOTICE

**SAVE THESE INSTRUCTIONS. DO NO DESTROY.**



