

**MAINTENANCE SECTION COVERING
STRAIGHT SPRING LOADED SPINDLES
for
450 SERIES D TORQUE MULTIPLIERS
WHEN THIS MODULE IS USED WITH AN ELECTRIC POWERED TOOL**

▲ WARNING



**IMPORTANT SAFETY INFORMATION ENCLOSED.
READ ALL THESE INSTRUCTIONS BEFORE PLACING TOOL IN SERVICE OR
OPERATING THIS TOOL AND SAVE THESE INSTRUCTIONS.
IT IS THE RESPONSIBILITY OF THE EMPLOYER TO PLACE THE INFORMATION
IN THIS MANUAL INTO THE HANDS OF THE OPERATOR.**

FAILURE TO OBSERVE THE FOLLOWING WARNINGS COULD RESULT IN INJURY.

Disconnect the Power Cord from the receptacle before performing any maintenance on this tool.



This symbol is to alert the user and service personnel to the presence of uninsulated dangerous voltage that will cause a risk of electric shock.



This symbol is to alert the user and service personnel to the presence of important operating instructions that must be read and understood to prevent personal injury, electrical shock or damage to the equipment.

**WHEN USING ELECTRIC TOOLS, BASIC SAFETY PRECAUTIONS SHOULD
ALWAYS BE FOLLOWED TO REDUCE THE RISK OF FIRE, ELECTRIC SHOCK
AND PERSONAL INJURY, INCLUDING THE FOLLOWING.**

PLACING TOOL IN SERVICE

- Use only with Ingersoll-Rand Series Controllers.
- Always operate, inspect and maintain this tool in accordance with all regulations (local, state, federal and country), that may apply to hand held/hand operated electric tools.
- Inspect tool cords periodically and if damaged, have them repaired by an authorized service facility.
- Do not remove any labels. Replace any damaged label.

USING THE TOOL

- Always wear eye protection when operating or performing maintenance on this tool.
- Always wear hearing protection when operating this tool.
- Power tools can vibrate in use. Vibration, repetitive motions, or uncomfortable positions may be harmful to your hands and arms. Stop using any tool if discomfort, tingling feeling or pain occurs. Seek medical advice before resuming use.

- **Guard Against Electric Shock.** Prevent body contact with earthed or grounded surfaces. For example; pipes, radiators, ranges, refrigerator enclosures.
- **Don't abuse Cord.** Never carry tool by cord or yank it to disconnect from receptacle. Keep cord from heat, oil, and sharp edges.
- **Keep work area clean.** Cluttered areas and benches invite injuries.
- **Consider work area environment.** Don't expose power tools and chargers to water. Keep work area well lighted. Do not use tool in explosive or flammable atmospheres.
- **Keep bystanders and children away.** Do not permit unauthorized personnel to operate this tool, or touch tool or cord.

(Continued on page 5-2)

NOTICE

The use of other than genuine Ingersoll-Rand replacement parts may result in safety hazards, decreased tool performance, and increased maintenance, and may invalidate all warranties.

Repairs should be made only by authorized trained personnel. Consult your nearest Ingersoll-Rand Authorized Servicenter.

Refer All Communications to the Nearest
Ingersoll-Rand Office or Distributor.

© Ingersoll-Rand Company 1999

Printed in U.S.A.

INGERSOLL-RAND®
PROFESSIONAL TOOLS



FAILURE TO OBSERVE THE FOLLOWING WARNINGS COULD RESULT IN INJURY.

USING THE TOOL (*Continued*)

- **Store idle tools.** When not in use, tools should be stored in a dry, high or locked up place, out of reach of children.
- **Don't force tool.** It will do the job better and more safely at the rate for which it was intended.
- **Use the right tool.** Do not force a small tool or attachment to do the job of a heavy-duty tool.
- **Do not use a tool for a purpose for which it is not intended.** Example: Do not use a screwdriver as a drill.
- **Dress properly.** Do not wear loose clothing or jewelry. They can be caught in moving parts. Rubber gloves and non-skid footwear are recommended when working outdoors. Wear protective hair covering to contain long hair.
- **Secure work.** Use clamps or a vise to hold work. Operators often need both hands to perform job functions.
- **Don't overreach.** Keep proper footing, balance, and a firm grip on the tool at all times.
- **Maintain tools with care.** Keep tools clean for better and safer performance. Follow instructions for lubricating and changing accessories. Inspect tool cords periodically and if damaged, have them repaired by an authorized service facility. Inspect extension cords periodically and replace if damaged. Keep handles dry, clean, and free from oil and grease.
- **Remove adjusting keys and wrenches.** Form habit of checking to see that keys and adjusting wrenches are removed from tool before turning it on.
- **Avoid unintentional starting.** Don't carry tool with finger on switch.
- **Do not drop or abuse the tool.**
- **Anticipate and be alert for sudden changes in motion during start up and operation of any power tool.**
- **Whenever a tool is not being used, position the Power Switch to the "OFF" position and unplug the power cord.**
- **Stay alert.** Watch what you are doing. Use common sense. Do not operate tool when you are tired.
- **Check damaged parts.** Before further use of the tool, a guard or other part that is damaged should be carefully checked to determine that it will operate properly and perform its intended function. Check for alignment of moving parts, binding of moving parts, breakage of parts, mounting, and any other conditions that may affect its operation. A guard or other part that is damaged should be properly repaired or replaced by an authorized service center unless otherwise indicated elsewhere in this operation manual.
- **Have defective switches replaced by an authorized service center.**
- **Do not use the tool if the switch does not turn it on and off.**
- **Whenever the Angle Head is installed or repositioned, the Throttle Lever must be positioned so that reaction torque will not tend to retain the throttle in the "ON" position.**
- **When installing or removing the output device on any tool, ALWAYS grasp a metal component of the tool while tightening or loosening the Coupling Nut or Spindle Cap. Acceptable clamping locations include, but are not limited to, the hex on the Gear Case, the Tool Hanger, the Torque Reaction Arm or any metal Mounting Plate. NEVER grasp the composite tool body or handle in vise jaws to restrain the torque of the Coupling Nut or Spindle Cap. Such practice will result in damage to the tool.**
- **Do not use power units and gear trains that exceed the capability of the output device.**
- **The Tube Nut Attachment has an opening on the front side for construction and application purposes. DO NOT, under any circumstance place your fingers in this opening.**
- **The Torque Reaction Bar must be positioned against a positive stop. Do not use the Bar as a dead handle and take all precautions to make certain the operator's hand cannot be pinched between the Bar and a solid object.**
- **When operated continuously for long periods of time, Series D Nutrunners may become hot at the spindle end of the tool. Take all precautions necessary to avoid skin contact with the hot surfaces. Prolonged contact may result in burns.**
- **All Series D Torque Control Wrenches and Nutrunners with reverse capability have rotational arrows molded into the housing in the area of the reversing mechanism. When the direction switching device is positioned nearest the molded circular arrow with an "F" in the center, spindle rotation will be forward or clockwise direction. When the direction switching device is positioned nearest the molded circular arrow with an "R" in the center, spindle rotation will be reverse or counterclockwise direction.**
- **Use only impact sockets and accessories. Do not use hand (chrome) sockets or accessories.**

WARNING LABEL IDENTIFICATION

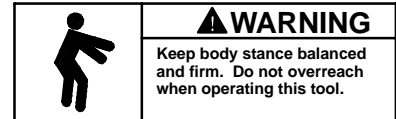
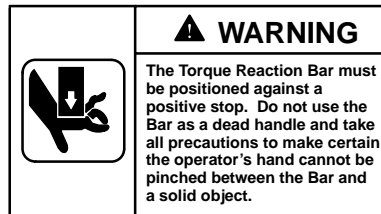
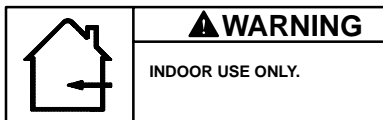
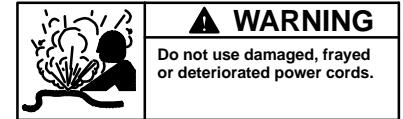
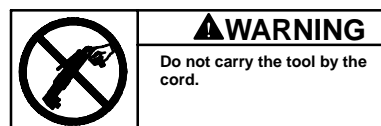
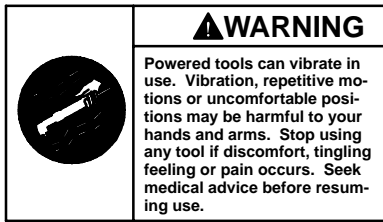
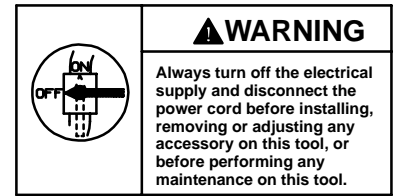
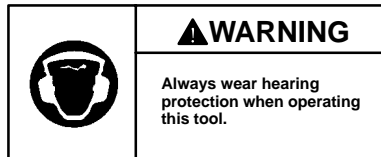
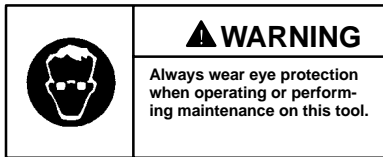

WHEN THIS MODULE IS USED WITH AN AIR POWERED TOOL

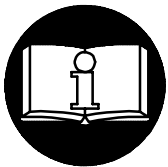

**IMPORTANT SAFETY INFORMATION ENCLOSED.
READ THIS MANUAL BEFORE OPERATING TOOL.**

**IT IS THE RESPONSIBILITY OF THE EMPLOYER TO PLACE THE INFORMATION
IN THIS MANUAL INTO THE HANDS OF THE OPERATOR.**

FAILURE TO OBSERVE THE FOLLOWING WARNINGS COULD RESULT IN INJURY.

PLACING TOOL IN SERVICE

- Always operate, inspect and maintain this tool in accordance with all regulations (local, state, federal and country), that may apply to hand held/hand operated pneumatic tools.
- For safety, top performance, and maximum durability of parts, operate this tool at 90 psig (6.2 bar/620 kPa) maximum air pressure at the inlet with 3/8" (10 mm) inside diameter air supply hose.
- Always turn off the air supply and disconnect the air supply hose before installing, removing or adjusting any accessory on this tool, or before performing any maintenance on this tool.
- Do not use damaged, frayed or deteriorated air hoses and fittings.
- Be sure all hoses and fittings are the correct size and are tightly secured.
- Always use clean, dry air at 90 psig maximum air pressure. Dust, corrosive fumes and/or excessive moisture can ruin the motor of an air tool.
- Do not lubricate tools with flammable or volatile liquids such as kerosene, diesel or jet fuel.
- Do not remove any labels. Replace any damaged label.

USING THE TOOL

- Always wear eye protection when operating or performing maintenance on this tool.
- Always wear hearing protection when operating this tool.
- Keep hands, loose clothing and long hair away from rotating end of tool.
- Note the position of the reversing lever before operating the tool so as to be aware of the direction of rotation when operating the throttle.
- Anticipate and be alert for sudden changes in motion during start up and operation of any power tool.
- Keep body stance balanced and firm. Do not overreach when operating this tool. High reaction torques can occur at or below the recommended air pressure.
- Tool shaft may continue to rotate briefly after throttle is released.
- Air powered tools can vibrate in use. Vibration, repetitive motions or uncomfortable positions may be harmful to your hands and arms. Stop using any tool if discomfort, tingling feeling or pain occurs. Seek medical advice before resuming use.

(Continued on page 5-4)









⚠ WARNING

FAILURE TO OBSERVE THE FOLLOWING WARNINGS COULD RESULT IN INJURY.

USING THE TOOL (Continued)

- Use accessories recommended by Ingersoll–Rand.
- Use only impact sockets and accessories. Do not use hand (chrome) sockets or accessories.
- This tool is not designed for working in explosive atmospheres.
- This tool is not insulated against electric shock.
- Do not remove the Inlet Plug without first disconnecting the live air supply.
- Whenever the Angle Head is installed or repositioned, the Throttle Lever must be positioned so that reaction torque will not tend to retain the throttle in the “ON” position.
- When installing or removing the output device on any tool, ALWAYS grasp a metal component of the tool while tightening or loosening the Coupling Nut or Spindle Cap. Acceptable clamping locations include, but are not limited to, the hex on the Gear Case, the Tool Hanger, the Torque Reaction Arm or any metal Mounting Plate. NEVER grasp the composite tool body or handle in vise jaws to restrain the torque of the Coupling Nut or Spindle Cap. Such practice will result in damage to the tool.
- Do not use power units and gear trains that exceed the capability of the output device.
- The Tube Nut Attachment has an opening on the front side for construction and application purposes. DO NOT, under any circumstance place your fingers in this opening.
- The Torque Reaction Bar must be positioned against a positive stop. Do not use the Bar as a dead handle and take all precautions to make certain the operator’s hand cannot be pinched between the Bar and a solid object.
- When operated continuously for long periods of time, Series D Nutrunners may become hot at the spindle end of the tool. Take all precautions necessary to avoid skin contact with the hot surfaces. Prolonged contact may result in burns.
- All Series D Torque Control Wrenches and Nutrunners with reverse capability have rotational arrows molded into the housing in the area of the reversing mechanism. When the direction switching device is positioned nearest the molded circular arrow with an “F” in the center, spindle rotation will be forward or clockwise direction. When the direction switching device is positioned nearest the molded circular arrow with an “R” in the center, spindle rotation will be reverse or counterclockwise direction.

WARNING LABEL IDENTIFICATION

	⚠ WARNING Always wear eye protection when operating or performing maintenance on this tool.		⚠ WARNING Always wear hearing protection when operating this tool.		⚠ WARNING Always turn off the air supply and disconnect the air supply hose before installing, removing or adjusting any accessory on this tool, or before performing any maintenance on this tool.
	⚠ WARNING Air powered tools can vibrate in use. Vibration, repetitive motions or uncomfortable positions may be harmful to your hands and arms. Stop using any tool if discomfort, tingling feeling or pain occurs. Seek medical advice before resuming use.		⚠ WARNING Do not carry the tool by the hose.		⚠ WARNING Do not use damaged, frayed or deteriorated air hoses and fittings.
	⚠ WARNING Keep body stance balanced and firm. Do not overreach when operating this tool.		⚠ WARNING Operate at 90 psig (6.2 bar/ 620 kPa) Maximum air pressure.		⚠ WARNING The Torque Reaction Bar must be positioned against a positive stop. Do not use the Bar as a dead handle and take all precautions to make certain the operator’s hand cannot be pinched between the Bar and a solid object.

INSTALLATION

These Spindles must be attached to a customer’s mounting plate that complies with specific bolt pattern and pilot alignment requirements. Contact Ingersoll–Rand for specific mounting dimensions.

During installation, tighten the mounting bolts between 10.25 and 10.75 ft–lb. (13.9 and 14.6 Nm) torque.

MAINTENANCE SECTION

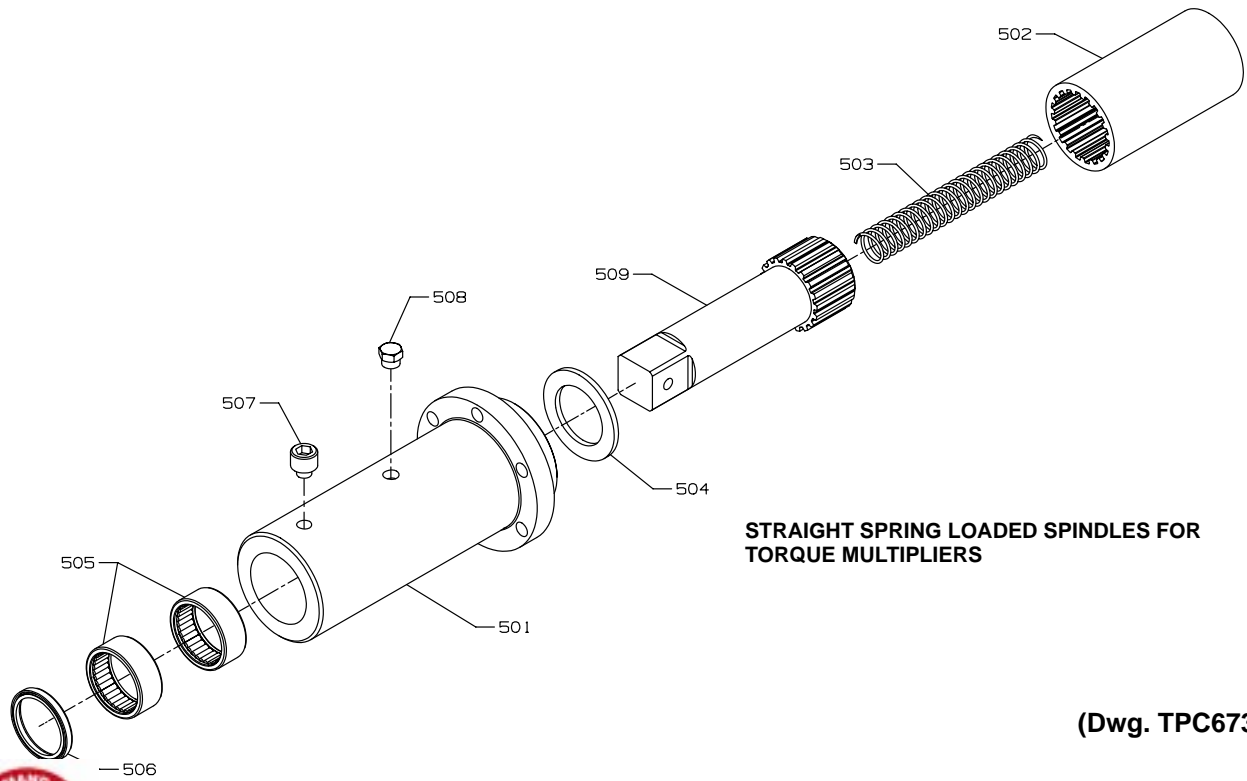

(Dwg. TPC673)



PART NUMBER FOR ORDERING

	Spindle Housing Assembly (does not include the Spindle)	
	for models with short stroke (5/8" stroke)	93808426
	for models with long stroke (1-1/2" stroke)	93807386
501	Spindle Housing	
	for models with short stroke	93808434-B
	for models with long stroke	93807428
502	Spindle Driver	
	for models with short stroke	93808459-B
	for models with long stroke	93807477-B
503	Spindle Thrust Spring	
	for models with short stroke	93929818
	for models with long stroke	93807808-A
504	Spindle Stop Washer	93913218
505	Spindle Bearing (2)	R3810-693
506	Spindle Seal	93929503
507	Socket Head Cap Screw	93807923-A
508	Pipe Plug (for models with long stroke only)	93945269
509	Spindle	
	3/4" square drive x 6" long	99377459
	3/4" square drive x 8" long	99377467
	3/4" square drive x 10" long	99377475
	3/4" square drive x 12" long	99377483
	1" square drive x 6" long	99377491
	1" square drive x 8" long	99377509
	1" square drive x 10" long	99377517
	1" square drive x 12" long	99377525

MAINTENANCE SECTION

Drive Spindle Bearing Replacement

NOTICE

Do not attempt to replace the Spindle Bearings (505) unless you have a new set of Bearings available for installation. Needle Bearings are always damaged during the removal process.

1. Disconnect any electronic readout devices that might be attached to the Spindle Housing Assembly.

CAUTION

In the following step, removing the Spring Loaded Spindle from the Tool creates two conditions for which precautions must be taken to prevent injury to the person disassembling the Tool. The Tool or Spindle Housing will be free to fall when the mounting bolts are removed from the assembly and the Spindle Thrust Spring (503) is free to eject from the Spindle (509) when the Tool and Spindle Housing are separated. Take all precautions necessary to avoid injury.

2. Carefully remove the six mounting bolts at the spindle end of the mounting plate. These bolts pass through the Spindle Housing (501) and mounting plate and are threaded into the housing of the torque multiplier. Do not allow the Tool or Spindle Housing Assembly to fall or the Spindle Thrust Spring (503) to be ejected when removing the bolts and separating the components.
3. Remove the Spindle Thrust Spring from the rear of the Spindle (509).
4. Push on the output end of the Spindle to move the Spindle Driver (502) and Spindle out the rear of the Spindle Housing (501).
5. If the Spindle Stop Washer (504) remained in the Spindle Housing, sharply rap the rear of the Housing on a block of wood to dislodge it. If it remained on the Spindle when the Spindle was removed, slide it off the Spindle.
6. Using a hooked tool, pull the Spindle Seal (506) out of the front end of the Spindle Housing.

NOTICE

In the next step, do not remove the Spindle Bearings (505) unless you have a new set of Bearings available for installation. Needle Bearings are always damaged during the removal process.

7. Using a bearing puller, pull the two Spindle Bearings (505) out of the Spindle Housing.

8. Stand the Spindle Housing on the table of an arbor press with the smaller central opening downward.
9. Using a bearing inserting tool as shown in Drawing TPD786, press a new Spindle Bearing into the smaller central opening until the trailing end of the Bearing is flush with the face of the opening.

NEEDLE BEARING INSERTING TOOL

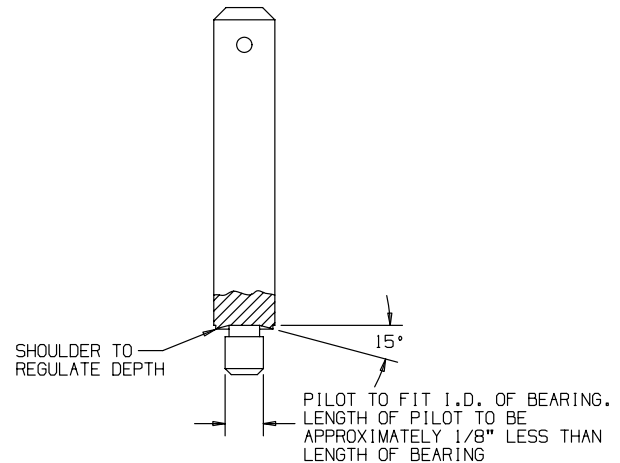

(Dwg. TPD786)

10. Invert the Housing on the table of the arbor press so that the large central opening is downward.
11. Install a stop collar on the bearing inserting tool that will allow the Bearing to be pressed to a depth that is 3/16" below the end face of the Housing and press the Bearing into the Housing until it is 3/16" below the Housing face.
12. Lubricate the Bearings with a light coat of Ingersoll-Rand No. 67 Grease.
13. Slide the Spindle Stop Washer onto the output shaft of the Spindle until it stops against the shaft shoulder. Lubricate the shaft and spline with a light coat of Ingersoll-Rand No. 67 Grease.
14. Lubricate the spline of the Spindle Driver with a light coat of Ingersoll-Rand No. 67 Grease and install the Spindle Driver on the Spindle by engaging the spline of the Driver with the spline of the Spindle.
15. Install the Spindle, Washer and Driver, spindle output end leading, in the large end of the Spindle Housing and through the Bearings.

MAINTENANCE SECTION

16. Being careful not to damage the Seal, install the Spindle Seal over the Spindle, closed end trailing, into the central opening against the Bearing that is pressed below the end face of the Housing. Make certain the closed end of the Seal is flush with the end face of the Housing.
17. Install the Spindle Thrust Spring into the central opening in the Spindle.
18. Using the rear hub of the Spindle Housing as a pilot, place the assembled Spindle housing against the mounting plate and align the bolt holes in the housing flange with the holes in the mounting plate.
19. Insert the square driver of the Tool through the opening in the mounting plate to engage the internal square of the Spindle Driver and align the bolt holes in the face of the Tool with the holes in the mounting plate.
20. Insert the mounting bolts through the Spindle Housing and mounting plate and thread them into the Tool. Tighten the bolts between 10.25 and 10.75 ft-lb. (13.9 and 14.6 Nm) torque.

NOTICE

SAVE THESE INSTRUCTIONS. DO NOT DESTROY.