

OPERATION AND MAINTENANCE MANUAL FOR 99S VERTICAL AIR SANDERS

NOTICE

Series 99S Vertical Air Sanders are designed for heavy duty sanding and polishing operations where space limitations are a factor. Ingersoll-Rand is not responsible for customer modification of tools for applications on which Ingersoll-Rand was not consulted.

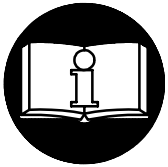

⚠ WARNING

**IMPORTANT SAFETY INFORMATION ENCLOSED.
READ THIS MANUAL BEFORE OPERATING TOOL.**

**IT IS THE RESPONSIBILITY OF THE EMPLOYER TO PLACE THE INFORMATION
IN THIS MANUAL INTO THE HANDS OF THE OPERATOR.
FAILURE TO OBSERVE THE FOLLOWING WARNINGS COULD RESULT IN INJURY.**

PLACING TOOL IN SERVICE

- Always operate, inspect and maintain this tool in accordance with American National Standards Institute Safety Code for Portable Air Tools (ANSI B186.1).
- For safety, top performance, and maximum durability of parts, operate this tool at 90 psig (6.2 bar/620 kPa) maximum air pressure at the inlet with 3/4" (19 mm) inside diameter air supply hose.
- Always turn off the air supply and disconnect the air supply hose before installing, removing or adjusting any accessory on this tool, or before performing any maintenance on this tool.
- Do not use damaged, frayed or deteriorated air hoses and fittings.
- Be sure all hoses and fittings are the correct size and are tightly secured. See Dwg. TPD905-1 for a typical piping arrangement.
- Always use clean, dry air at 90 psig maximum air pressure. Dust, corrosive fumes and/or excessive moisture can ruin the motor of an air tool.
- Do not lubricate tools with flammable or volatile liquids such as kerosene, diesel or jet fuel.
- Do not remove any labels. Replace any damaged label.
- Always wear hearing protection when operating this tool.
- Keep hands, loose clothing and long hair away from rotating end of tool.
- Anticipate and be alert for sudden changes in motion during start up and operation of any power tool.
- Keep body stance balanced and firm. Do not overreach when operating this tool. High reaction torques can occur at or below the recommended air pressure.
- Check for excessive speed and vibration before operating.
- Tool shaft may continue to rotate briefly after throttle is released.
- Air powered tools can vibrate in use. Vibration, repetitive motions or uncomfortable positions may be harmful to your hands and arms. Stop using any tool if discomfort, tingling feeling or pain occurs. Seek medical advice before resuming use.
- Use accessories recommended by Ingersoll-Rand.
- This tool is not designed for working in explosive atmospheres.
- This tool is not insulated against electric shock.

USING THE TOOL

- Always wear eye protection when operating or performing maintenance on this tool.

NOTICE

The use of other than genuine Ingersoll-Rand replacement parts may result in safety hazards, decreased tool performance, and increased maintenance, and may invalidate all warranties.

Repairs should be made only by authorized trained personnel. Consult your nearest Ingersoll-Rand Authorized Servicenter.

Refer All Communications to the Nearest
Ingersoll-Rand Office or Distributor.

© Ingersoll-Rand Company 1999

Printed in U.S.A.

INGERSOLL-RAND®
PROFESSIONAL TOOLS

WARNING LABEL IDENTIFICATION

⚠ WARNING

FAILURE TO OBSERVE THE FOLLOWING WARNINGS COULD RESULT IN INJURY.

	⚠ WARNING
	Always wear eye protection when operating or performing maintenance on this tool.

	⚠ WARNING
	Always wear hearing protection when operating this tool.

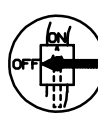
	⚠ WARNING
	Always turn off the air supply and disconnect the air supply hose before installing, removing or adjusting any accessory on this tool, or before performing any maintenance on this tool.

	⚠ WARNING
	Air powered tools can vibrate in use. Vibration, repetitive motions or uncomfortable positions may be harmful to your hands and arms. Stop using any tool if discomfort, tingling feeling or pain occurs. Seek medical advice before resuming use.

	⚠ WARNING
	Do not carry the tool by the hose.

	⚠ WARNING
	Do not use damaged, frayed or deteriorated air hoses and fittings.

	⚠ WARNING
	Keep body stance balanced and firm. Do not overreach when operating this tool.

	⚠ WARNING
	Operate at 90 psig (6.2 bar/620 kPa) Maximum air pressure.

SANDER SPECIFIC WARNINGS

- These Sanders will operate at the free speed specified on the nameplate if the air supply line furnishes 90 psig (6.2 bar/620 kPa) air pressure at the tool. Operation at higher air pressure will result in excessive speed.
- Use only a sanding pad, buffing wheel or polishing bonnet with these tools. Do not use any grinding wheel, bur or metal removing accessory with these tools. Never use an accessory having a maximum operating speed less than the free speed of the Sander in which it is being used.
- When using a pad having a shank, insert the shank to full depth in the collet. When using a pad on a threaded arbor, make certain the flange nut is tightened securely. Check the tightness of the collet nut or flange nut before operating a Sander to make certain it will not loosen during operation.
- Do not attempt to disassemble the Controller. The Controller is available only as a unit and is guaranteed for the life of the tool if it is not abused.

PLACING TOOL IN SERVICE

LUBRICATION



Ingersoll-Rand No. 50

Always use an air line lubricator with these tools.
We recommend the following Filter-Lubricator-Regulator Unit:

For USA - No. C31-06-G00

Before starting the tool, unless the air line lubricator is used, detach the air hose and inject about 1.5 cc of oil into the air inlet. **For models with a built-in oiler**, remove the Oil Chamber Plug and fill the chamber.

After each eight hours of operation, or as experience indicates, replenish the oil supply in the Handle.

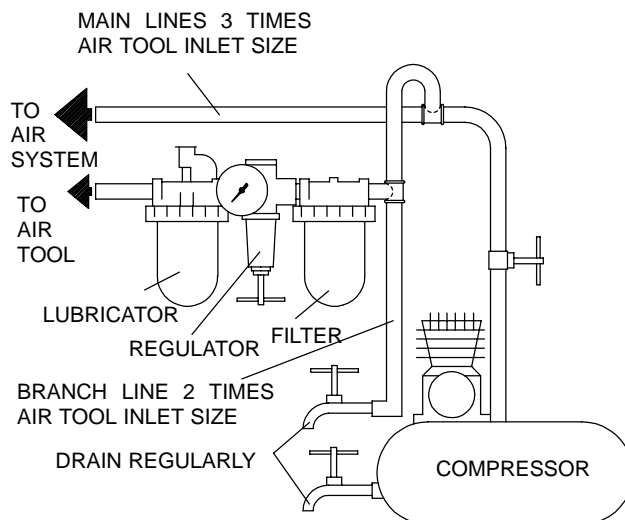

(Dwg. TPD905-1)

HOW TO ORDER A SANDER

VERTICAL DISK WHEEL SANDER

Model	Free Speed, rpm	Spindle and Back Up Pad
99S45W109	4,500	5/8-11, 9"
99S60W107	6,000	5/8-11, 7"

MANUEL D'EXPLOITATION ET D'ENTRETIEN DE LA SÉRIE 99S

NOTE

Les ponceuses verticales de la Série 99S sont destinées aux grosses opérations de ponçage et de polissage où l'espace disponible est limité.

Ingersoll-Rand ne peut être tenu responsable de la modification des outils par le client pour les adapter à des applications qui n'ont pas été approuvées par Ingersoll-Rand.

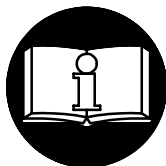

ATTENTION

**D'IMPORTANTES INFORMATIONS DE SECURITÉ SONT JOINTES.
LIRE CE MANUEL AVANT D'UTILISER L'OUTIL.**

**L'EMPLOYEUR EST TENU DE COMMUNIQUER LES INFORMATIONS
DE CE MANUEL AUX EMPLOYÉS UTILISANT CET OUTIL.**

LE NON RESPECT DES AVERTISSEMENTS SUIVANTS PEUT CAUSER DES BLESSURES.

MISE EN SERVICE DE L'OUTIL

- Toujours exploiter, inspecter et entretenir cet outil conformément au Code de sécurité des outils pneumatiques portatifs de l'American National Standards Institute (ANSI B186.1).
- Pour la sécurité, les performances optimales et la durabilité maximale des pièces, cet outil doit être connecté à une alimentation d'air comprimé de 6,2 bar (620 kPa) maximum à l'entrée, avec un flexible de 19 mm de diamètre intérieur.
- Couper toujours l'alimentation d'air comprimé et débrancher le flexible d'alimentation avant d'installer, déposer ou ajuster tout accessoire sur cet outil, ou d'entreprendre une opération d'entretien quelconque sur l'outil.
- Ne pas utiliser des flexibles ou des raccords endommagés, effilochés ou détériorés.
- S'assurer que tous les flexibles et les raccords sont correctement dimensionnés et bien serrés. Voir Plan TPD905-1 pour un exemple type d'agencement des tuyauteries.
- Utiliser toujours de l'air sec et propre à une pression maximum de 6,2 bar. La poussière, les fumées corrosives et/ou une humidité excessive peuvent endommager le moteur d'un outil pneumatique.
- Ne jamais lubrifier les outils avec des liquides inflammables ou volatils tels que le kérosène, le gasol ou le carburant d'aviation.
- Ne retirer aucune étiquette. Remplacer toute étiquette endommagée.

UTILISATION DE L'OUTIL

- Porter toujours des lunettes de protection pendant l'utilisation et l'entretien de cet outil.

- Porter toujours une protection acoustique pendant l'utilisation de cet outil.
- Tenir les mains, les vêtements fous et les cheveux longs, éloignés de l'extrémité rotative de l'outil.
- Prévoir, et ne pas oublier, que tout outil motorisé est susceptible d'à-coups brusques lors de sa mise en marche et pendant son utilisation.
- Garder une position équilibrée et ferme. Ne pas se pencher trop en avant pendant l'utilisation de cet outil. Des couples de réaction élevés peuvent se produire à, ou en dessous, de la pression d'air recommandée.
- Vérifier que la vitesse et les vibrations ne sont pas excessives avant d'utiliser l'outil.
- La rotation des accessoires de l'outil peut continuer pendant un certain temps après le relâchement de la gâchette.
- Les outils pneumatiques peuvent vibrer pendant l'exploitation. Les vibrations, les mouvements répétitifs et les positions inconfortables peuvent causer des douleurs dans les mains et les bras. N'utiliser plus d'outils en cas d'inconfort, de picotements ou de douleurs. Consulter un médecin avant de recommencer à utiliser l'outil.
- Utiliser les accessoires recommandés par Ingersoll-Rand.
- Esta herramienta no ha sido diseñada para trabajar en ambientes explosivos.
- Esta herramienta no está aislada contra descargas eléctricas.

NOTE

L'utilisation de rechanges autres que les pièces d'origine Ingersoll-Rand peut causer des risques d'insécurité, réduire les performances de l'outil et augmenter l'entretien, et peut annuler toutes les garanties.

Les réparations ne doivent être effectuées que par des réparateurs qualifiés autorisés. Consultez votre Centre de Service Ingersoll-Rand le plus proche.

Adressez toutes vos communications au Bureau Ingersoll-Rand ou distributeur le plus proche.

© Ingersoll-Rand Company 1999

Imprimé aux É.U.

INGERSOLL-RAND®
PROFESSIONAL TOOLS

SIGNIFICATION DES ETIQUETTES D'AVERTISSEMENT

ATTENTION

LE NON RESPECT DES AVERTISSEMENTS SUIVANTS PEUT CAUSER DES BLESSURES

	<p>ATTENTION</p> <p>Porter toujours des lunettes de protection pendant l'utilisation et l'entretien de cet outil.</p>
---	--

	<p>ATTENTION</p> <p>Porter toujours une protection acoustique pendant l'utilisation de cet outil.</p>
---	--

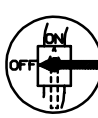
	<p>ATTENTION</p> <p>Couper toujours l'alimentation d'air comprimé et débrancher le flexible d'alimentation avant d'installer, déposer ou ajuster tout accessoire sur cet outil, ou d'entreprendre une opération d'entretien quelconque sur l'outil.</p>
---	--

	<p>ATTENTION</p> <p>Les outils pneumatiques peuvent vibrer pendant l'exploitation. Les vibrations, les mouvements répétitifs et les positions inconfortables peuvent causer des douleurs dans les mains et les bras. N'utiliser plus d'outils en cas d'inconfort, de picotements ou de douleurs. Consulter un médecin avant de recommencer à utiliser l'outil.</p>
---	---

	<p>ATTENTION</p> <p>Ne pas transporter l'outil par son flexible.</p>
---	---

	<p>ATTENTION</p> <p>Ne pas utiliser des flexibles ou des raccords endommagés, effilochés ou détériorés.</p>
---	--

	<p>ATTENTION</p> <p>Garder une position équilibrée et ferme. Ne pas se pencher trop en avant pendant l'utilisation de cet outil.</p>
---	---

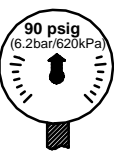
	<p>ATTENTION</p> <p>Utiliser de l'air comprimé à une pression maximum de 6,2 bar (620 kPa).</p>
---	--

AVERTISSEMENTS SPÉCIFIQUES AUX PONCEUSES

- Ces ponceuses tourneront à la vitesse à vide spécifiée sur la plaque signalétique lorsque le circuit d'alimentation fournit de l'air à une pression de 6,2 bar (620 kPa) à l'outil. L'exploitation à une pression supérieure produira une vitesse excessive.
- Utiliser seulement un plateau de ponçage, un disque de polissage ou une peau de mouton de polissage avec ces outils. Ne jamais utiliser de meule ou d'accessoire d'ébavurage ou d'enlèvement de métal sur ces outils. Ne jamais utiliser d'accessoire ayant une vitesse de fonctionnement maximum inférieure à la vitesse à vide de la ponceuse sur laquelle il est utilisé.
- Lorsqu'un plateau de ponçage à tige est utilisé, insérer la tige à fond dans la pince. Lorsqu'un plateau est utilisé sur un arbre fileté, vérifier que l'écrou de bride est fermement serré. Vérifier le serrage de l'écrou de pince ou de l'écrou d'arbre avant de mettre la ponceuse en marche, et vérifier qu'il ne se desserre pas pendant l'exploitation.
- Ne jamais essayer de démonter le contrôleur. Ce dernier est fourni seulement comme un ensemble et est garanti pendant toute la durée de vie de l'outil s'il est utilisé correctement.

MISE EN SERVICE DE L'OUTIL

LUBRIFICATION



Ingersoll-Rand No. 50

Utiliser toujours un lubrificateur avec ces outils. Nous recommandons l'emploi du filtre-régulateur-lubrificateur suivant :

N°. C31-06-G00

Avant de mettre l'outil en marche, si un lubrificateur de ligne n'est pas utilisé, débrancher le flexible d'alimentation et verser environ 1,5 cm³ d'huile dans le raccord d'admission de l'outil. **Sur les modèles dotés d'un huileur incorporé**, déposer le bouchon de l'huileur du corps du cylindre et remplir la chambre d'huile.

Toutes les huit heures de fonctionnement, ou en fonction de l'expérience, remplir la réserve d'huile de la poignée.

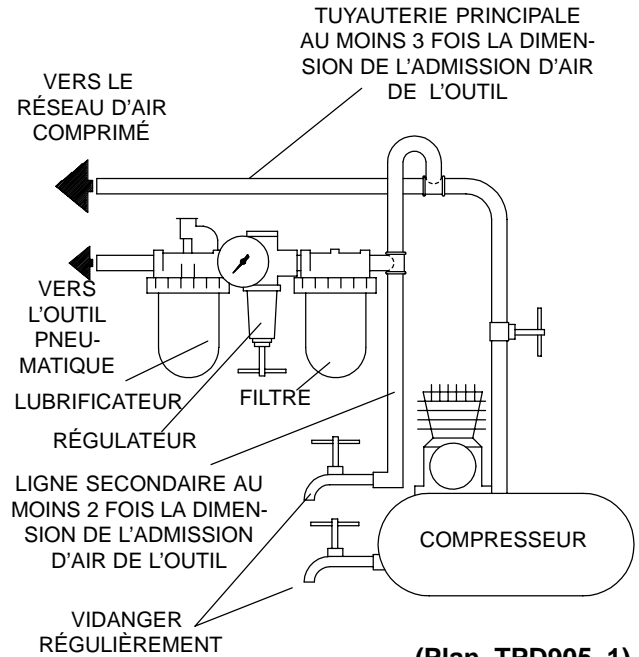

(Plan TPD905-1)

SPÉCIFICATIONS

Modèle	Vitesse libre	
	tr/mn	
	Broche et plateau d'appui	
99S45W109	4.500	5/8-11, 9"
99S60W107	6.000	5/8-11, 7"

MANUAL DE FUNCIONAMIENTO Y MANTENIMIENTO

LIJADORAS VERTICALES DE LA SERIE 99S

NOTA

Las lijadoras neumáticas verticales de la serie 99S están diseñadas para trabajos de lijado y pulido de alto rendimiento en aquellas situaciones en que el espacio es reducido. Ingersoll-Rand no aceptará responsabilidad alguna por la modificación de las herramientas efectuada por el cliente para las aplicaciones que no hayan sido consultadas con Ingersoll-Rand.



AVISO

**SE ADJUNTA INFORMACIÓN IMPORTANTE DE SEGURIDAD.
LEA ESTE MANUAL ANTES DE UTILIZAR LA HERRAMIENTA.**

**ES RESPONSABILIDAD DE LA EMPRESA ASEGURARSE DE QUE EL OPERARIO
ESTÉ AL TANTO DE LA INFORMACIÓN QUE CONTIENE ESTE MANUAL.**

EL HACER CASO OMISO DE LOS AVISOS SIGUIENTES PODRÍA OCASIONAR LESIONES.

PARA PONER LA HERRAMIENTA EN SERVICIO

- Utilice, examine y mantenga siempre esta herramienta conforme al código de seguridad para herramientas neumáticas portátiles de la American National Standards Institute (ANSI B186.1).
- Para mayor seguridad, rendimiento óptimo y larga vida útil de las piezas, utilice esta herramienta a una presión de aire máxima de 90 psig (6,2 bar/620 kPa) con una manguera de suministro de aire con diámetro interno de 19 mm.
- Corte siempre el suministro de aire y desconecte la manguera de suministro de aire antes de instalar, desmontar o ajustar cualquier accesorio de esta herramienta, o antes de realizar cualquier operación de mantenimiento de la misma.
- No utilice mangueras de aire y racores dañados, desgastados o deteriorados.
- Asegúrese de que todos los racores y mangueras sean del tamaño correcto y estén bien apretados. El Esq. TPD905-1 muestra una disposición característica de las tuberías.
- Use siempre aire limpio y seco a una presión máxima de 90 psig (6,2 bar/620 kPa). El polvo, los gases corrosivos y/o el exceso de humedad pueden estropear el motor de una herramienta neumática.
- No lubrique las herramientas con líquidos inflamables o volátiles tales como queroseno, gasoil o combustible para motores a reacción.
- No saque ninguna etiqueta. Sustituya toda etiqueta dañada.

UTILIZACIÓN DE LA HERRAMIENTA

- Use siempre protección ocular cuando utilice esta herramienta o realice operaciones de mantenimiento en la misma.

- Use siempre protección para los oídos cuando utilice esta herramienta.
- Mantenga las manos, la ropa suelta y el cabello largo alejados del extremo giratorio de la herramienta.
- Anticipe y esté alerta a los cambios repentinos en el movimiento durante la puesta en marcha y utilización de toda herramienta motorizada.
- Mantenga una postura del cuerpo equilibrada y firme. No estire demasiado los brazos al manejar la herramienta. Pueden darse elevados pares de reacción a la presión de aire recomendada, e incluso a presiones inferiores.
- Compruebe que no haya exceso de velocidad o vibración de la herramienta antes de utilizarla.
- El eje de la herramienta puede seguir girando brevemente después de haberse soltado la palanca de mando.
- Las herramientas neumáticas pueden vibrar durante el uso. La vibración, los movimientos repetitivos o las posiciones incómodas pueden dañarle los brazos y manos. En caso de incomodidad, sensación de hormigueo o dolor, deje de usar la herramienta. Consulte al médico antes de volver a utilizarla.
- Utilice únicamente los accesorios recomendados por Ingersoll-Rand.
- Esta herramienta no ha sido diseñada para trabajar en ambientes explosivos.
- Esta herramienta no está aislada contra descargas eléctricas.

NOTA

El uso de piezas de recambio que no sean las auténticas piezas Ingersoll-Rand puede poner en peligro la seguridad, reducir el rendimiento de la herramienta y aumentar los cuidados de mantenimiento necesarios, así como invalidar toda garantía.

Las reparaciones sólo se deben encomendar a personal debidamente cualificado y autorizado. Consulte con el centro de servicio autorizado Ingersoll-Rand más próximo.

Toda comunicación se deberá dirigir a la oficina o al distribuidor Ingersoll-Rand más próximo.

© Ingersoll-Rand Company 1999

Impreso en EE. UU.

INGERSOLL-RAND®
PROFESSIONAL TOOLS

ETIQUETAS DE AVISO

⚠ AVISO

EL HACER CASO OMISO DE LOS AVISOS SIGUIENTES PODRÍA OCASIONAR LESIONES.

	<p>⚠ ADVERTENCIA</p> <p>Use siempre protección ocular cuando utilice esta herramienta o realice operaciones de mantenimiento en la misma.</p>
---	--

	<p>⚠ ADVERTENCIA</p> <p>Use siempre protección para los oídos cuando utilice esta herramienta.</p>
---	---

	<p>⚠ ADVERTENCIA</p> <p>Cortar siempre el suministro de aire y desconectar la manguera de suministro de aire antes de instalar, retirar o ajustar cualquier accesorio de esta herramienta, o antes de realizar cualquier operación de mantenimiento de la misma.</p>
---	---

	<p>⚠ ADVERTENCIA</p> <p>Las herramientas neumáticas pueden vibrar durante el uso. La vibración, los movimientos repetitivos o las posiciones incómodas podrían dañarle los brazos y las manos. En caso de incomodidad, sensación de hormigueo o dolor, dejar de usar la herramienta. Consultar al médico antes de volver a utilizarla.</p>
---	---

	<p>⚠ ADVERTENCIA</p> <p>No coger la herramienta por la manguera para levantarla.</p>
---	---

	<p>⚠ ADVERTENCIA</p> <p>No utilizar mangueras de aire y accesorios dañados, desgastados ni deteriorados.</p>
---	---

	<p>⚠ ADVERTENCIA</p> <p>Mantener una postura del cuerpo equilibrada y firme. No estirar demasiado los brazos al manejar la herramienta.</p>
---	--

	<p>⚠ ADVERTENCIA</p> <p>Manejar la herramienta a una presión de aire máxima de 90 psig (6,2 bar/620 kPa).</p>
---	--

AVISOS ESPECÍFICOS SOBRE LAS LIJADORAS

- Estas lijadoras funcionan a la velocidad en vacío que se indica en la placa de identificación si la red de aire comprimido suministra a la herramienta aire a una presión de 90 psig (6,2 bar/620 kPa). El manejo a una presión superior producirá un exceso de velocidad.
- Utilice solamente discos de lijar o de pulir con estas herramientas. No utilice muelas de rectificar, fresas ni accesorios de desbarbado de metal con estas herramientas. No utilice nunca un accesorio cuya velocidad máxima de funcionamiento sea inferior a la velocidad en vacío de la lijadora con la que se emplea.
- Al utilizar un disco con eje, introduzca el eje completamente en la pinza. Cuando utilice un disco en un eje roscado, asegúrese de que la tuerca de la brida quede bien apretada. Compruebe el apriete de la tuerca de la pinza o de la brida antes de accionar la lijadora para asegurarse de que no se afloje durante el funcionamiento.
- No intente desarmar el estrangulador. Éste está disponible únicamente como conjunto y está garantizado para toda la vida útil de la herramienta, siempre que se utilice como es debido.

PARA PONER LA HERRAMIENTA EN SERVICIO

LUBRICACIÓN



Ingersoll-Rand N° 50

Utilice siempre un lubricador de aire comprimido con estas herramientas. Recomendamos utilizar el siguiente conjunto de filtro-lubricador-regulador:

Para USA – N° C31-06-G00

Antes de accionar la herramienta, salvo que se utilice un lubricador de aire comprimido, desconecte la manguera de aire e inyecte unos 1,5 cc de aceite en el conjunto de admisión. **Modelos con lubricador incorporado:** saque el tapón de la cámara de aceite de la carcasa del cilindro y llene la cámara.

Después de cada ocho horas de funcionamiento, o según indique la experiencia, reponga el nivel de aceite en la empuñadura.

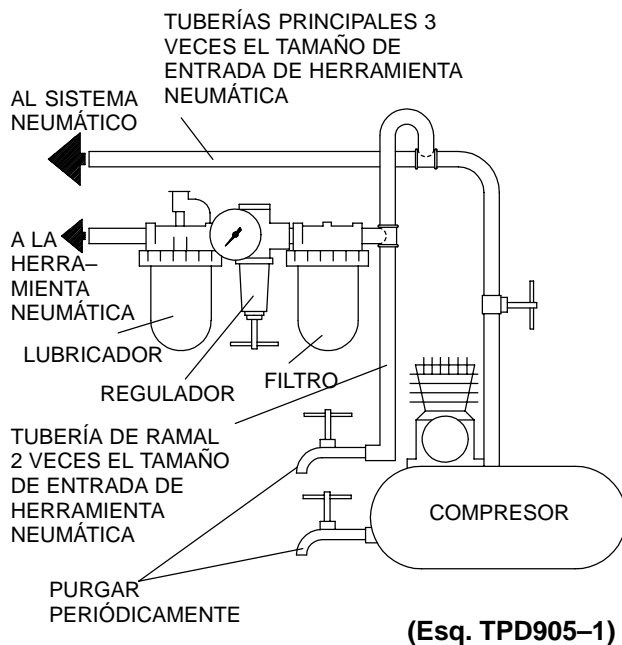

ESPECIFICACIONES

Modelo	Velocidad en vacío	Husillo y disco soporte
	rpm	
99S45W109	4.500	5/8-11, 9"
99S60W107	6.000	5/8-11, 7"

MANUAL DE FUNCIONAMENTO E MANUTENÇÃO LIXADEIRAS PNEUMÁTICAS VERTICAIS SÉRIE 99S

AVISO

As Lixadeiras Pneumáticas Verticais Série 99S são concebidas para operações pesadas de lixar e polir, onde as limitações de espaço são um factor relevante.

A Ingersoll-Rand não pode ser responsabilizada pela modificação de ferramentas para aplicações para as quais não tenha sido consultada.

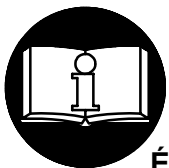

⚠️ ADVERTÊNCIA

**IMPORTANTES INFORMAÇÕES DE SEGURANÇA EM ANEXO.
LEIA ESTE MANUAL ANTES DE OPERAR A FERRAMENTA.**

**É RESPONSABILIDADE DA ENTIDADE PATRONAL PÔR AS INFORMAÇÕES
CONTIDAS NESTE MANUAL À DISPOSIÇÃO DOS UTILIZADORES.**

A NÃO OBEDIÊNCIA ÀS ADVERTÊNCIAS SEGUINTE PODERÁ RESULTAR EM LESÕES PESSOAIS.

COLOCAÇÃO DA FERRAMENTA EM SERVIÇO

- Sempre opere, inspeccione e mantenha esta ferramenta de acordo com o Código de Segurança do Instituto Americano de Padrões Nacionais para Ferramentas Pneumáticas Portáteis (ANSI B186.1).
- Para segurança, desempenho superior e durabilidade máxima das peças, opere esta ferramenta a uma pressão de ar máxima de 90 psig (6,2 bar/620 kPa) na admissão com uma mangueira de alimentação de ar com diâmetro interno de 3/4 pol. (19 mm).
- Desligue sempre a alimentação de ar e a mangueira de alimentação de ar antes de instalar, retirar ou ajustar qualquer acessório desta ferramenta, ou antes de fazer manutenção na mesma.
- Não utilize mangueiras de ar e acessórios danificados, puídos ou deteriorados.
- Certifique-se de que todas as mangueiras e acessórios são da dimensão correcta e que estão seguros firmemente. Consulte o Des. TPD905-1 para uma disposição de tubos típica.
- Utilize sempre ar limpo e seco a uma pressão máxima de 90 psig. Poeira, fumos corrosivos e/ou humidade excessiva podem destruir o motor de uma ferramenta pneumática.
- Não lubrifique a ferramenta com líquidos inflamáveis ou voláteis como querosene, gasóleo ou combustível para jactos.
- Não retire nenhum rótulo. Substitua os rótulos danificados.

UTILIZAÇÃO DA FERRAMENTA

- Use sempre protecção para os olhos ao operar ou fazer manutenção nesta ferramenta.
- Use sempre protecção auricular ao operar esta ferramenta.
- Mantenha as mãos, roupas soltas e cabelos longos afastados da extremidade rotativa da ferramenta.
- Esteja preparado e alerta para mudanças súbitas no movimento durante o arranque e o funcionamento de qualquer ferramenta mecânica.
- Mantenha o corpo numa posição equilibrada e firme. Não estique o corpo ao operar esta ferramenta. Podem ocorrer binários de reacção elevados à ou abaixo da pressão do ar recomendada.
- Verifique a ferramenta quanto a velocidade ou vibração excessiva antes de a operar.
- O veio da ferramenta pode continuar a rodar por um curto período de tempo depois de soltar o regulador.
- A ferramentas pneumáticas podem vibrar durante a utilização. Vibração, movimentos repetitivos ou posições desconfortáveis podem ser nocivos às suas mãos e braços. Pare de utilizar qualquer ferramenta se ocorrer desconforto, sensação de formigueiro ou dor. Procure assistência médica antes de reiniciar a utilização.
- Use os acessórios recomendados pela Ingersoll-Rand.
- Esta ferramenta não é concebida para funcionar em atmosferas explosivas.
- Esta ferramenta não é isolada contra choque eléctrico.

AVISO

A utilização de qualquer peça sobresselente que não seja Ingersoll-Rand genuína pode resultar em riscos para a segurança, em desempenho reduzido da ferramenta e mais necessidade de manutenção, e pode invalidar todas as garantias.

As reparações só devem ser feitas por pessoal autorizado e com formação adequada. Consulte o Representante Autorizado Ingersoll-Rand mais próximo.

Envie toda a correspondência ao Escritório ou Distribuidor Ingersoll-Rand mais próximo.

© Ingersoll-Rand Company 1999

Impresso nos E.U.A.

INGERSOLL-RAND®
PROFESSIONAL TOOLS

IDENTIFICAÇÃO DAS ETIQUETAS DE ADVERTÊNCIA

⚠ ADVERTÊNCIA

A NÃO OBEDIÊNCIA ÀS ADVERTÊNCIAS SEGUINTES PODERÁ RESULTAR EM LESÕES PESSOAIS.

	⚠ ADVERTÊNCIA Use sempre protecção para os olhos ao operar ou fazer manutenção nesta ferramenta.
---	--

	⚠ ADVERTÊNCIA Use sempre protecção auricular ao operar esta ferramenta.
---	---

	⚠ ADVERTÊNCIA Desligue sempre a alimentação de ar e a mangueira de alimentação de ar antes de instalar, remover ou ajustar um acessório desta ferramenta, ou antes de fazer manutenção na mesma.
---	--

	⚠ ADVERTÊNCIA As ferramentas pneumáticas podem vibrar durante a utilização. Vibração, movimentos repetitivos ou posições desconfortáveis podem ser nocivos às suas mãos e braços. Pare de utilizar qualquer ferramenta se ocorrer desconforto, sensação de formigamento ou dor. Procure assistência médica antes de reiniciar a utilização.
---	---

	⚠ ADVERTÊNCIA Não transporte a ferramenta pela mangueira.
---	---

	⚠ ADVERTÊNCIA Não utilize mangueiras de ar e acessórios danificados, puidos ou deteriorados.
---	--

	⚠ ADVERTÊNCIA Mantenha o corpo numa posição equilibrada e firme. Não estique o corpo ao operar esta ferramenta.
---	---

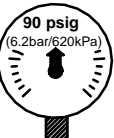
	⚠ ADVERTÊNCIA Opere a uma pressão de ar máxima de 90 psig (6,2 bar/ 620 kPa).
---	---

ADVERTÊNCIAS ESPECIAIS PARA A LIXADEIRA

- Estas Lixadeiras funcionarão à velocidade livre especificada na placa de identificação se a linha de ar fornecer pressão de ar a 90 psig (6,2 bar/ 620 kPa) na ferramenta. A operação a uma pressão mais elevada resultará em velocidade excessiva.
- Utilize apenas uma almofada de lixar, roda de polir ou boina de polir com estas ferramentas. Não utilize mó abrasiva, rebarbador ou acessório para remoção de metal com estas ferramentas. Nunca utilize um acessório que tenha uma velocidade máxima de funcionamento abaixo da velocidade livre da Lixadeira na qual o acessório está a ser utilizado.
- Ao utilizar uma almofada que tenha um veio, introduza-o totalmente no mandril. Ao utilizar uma almofada num veio roscado, certifique-se de que a porca de flange está apertada firmemente. Verifique o aperto da porca do mandril ou da porca de flange antes de operar a Lixadeira para assegurar que a porca não desapertará durante o funcionamento.
- Não tente desmontar o Controlador. O Controlador só está disponível como uma unidade e é garantido durante a vida útil da ferramenta, se não for maltratado.

COLOCAÇÃO DA FERRAMENTA EM SERVIÇO

LUBRIFICAÇÃO



Ingersoll-Rand Nº 50

Utilize sempre um lubrificador de linha de ar com estas ferramentas.

Recomendamos a seguinte Unidade Filtro-Lubrificador-Regulador:

Nº. C31-06-G00

Antes de ligar a ferramenta, a menos que o lubrificador de linha de ar esteja a ser utilizado, desligue a mangueira de ar e injecte aproximadamente 1,5 cc de óleo na admissão de ar.

Para modelos com lubrificador incorporado, remova o bujão de óleo da câmara da caixa do cilindro e encha a câmara.

Após cada oito horas de funcionamento, ou conforme a experiência indicar, complete o abastecimento de óleo na Pega.

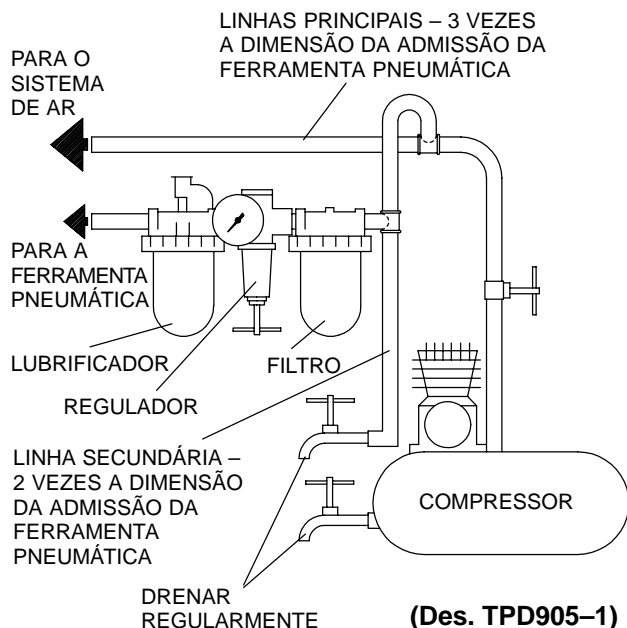

ESPECIFICAÇÕES

Modelo	Velocidade Livre	Haste e Almofada de Apoio
	rpm	mm (pol.)
99S45W109	4.500	5/8-11, 9"
99S60W107	6.000	5/8-11, 7"

USE THIS DRAWING WITH PART LISTING FOR MODELS WITHOUT BUILT-IN OILERS

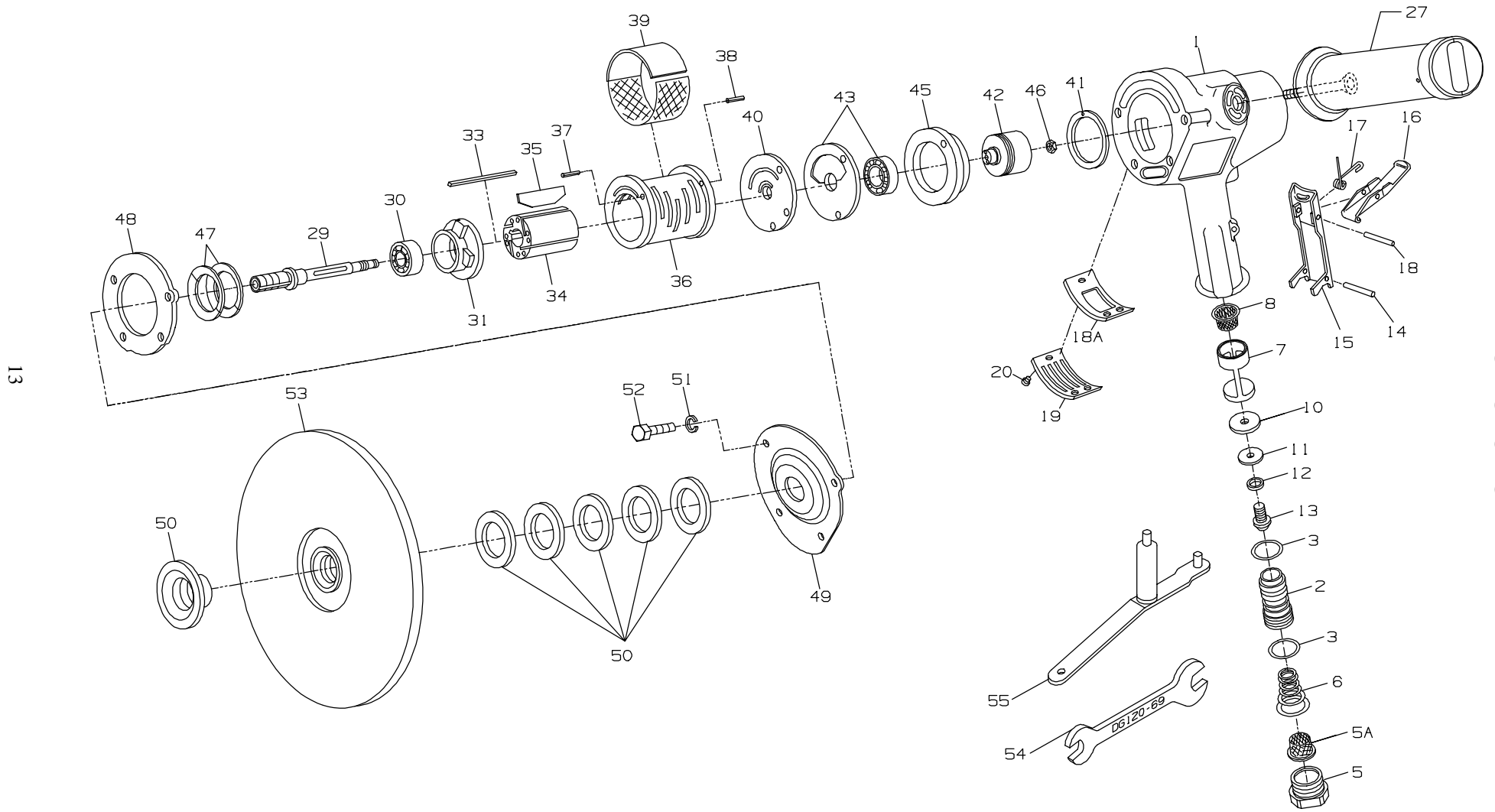

MAINTENANCE SECTION

(Dwg. TPA1709)

USE THIS PART LISTING WITH DRAWING TPA1709 FOR MODELS WITHOUT BUILT-IN OILERS



PART NUMBER FOR ORDERING

PART NUMBER FOR ORDERING

+ 1	Cylinder Case Assembly	99V60-EU-A25A	18A	Exhaust Diffuser (not used on	
2	Throttle Valve Assembly	88V60-A302		99S45 or 99S60)	99V77-123
3	Throttle Seal (2)	C321-606	19	Exhaust Deflector	99V60-23
5	Inlet Bushing	88V60-38	20	Exhaust Deflector Screw (3)	99V60-200
• 5A	Inlet Bushing Screen	834-61	*	Nameplate Kit	99V-K301A
• 6	Throttle Valve Spring	99V60-262		Nameplate Screw (4)	BN403-302
7	Throttle Valve Seat Support Assembly	88V60-A303		Warning Label	WARNING-4-99
• 8	Air Strainer Screen	834-61	27	Dead Handle	ERG0-A48
• 10	Valve Seat	R4-159A	29	Arbor	
11	Valve Seat Washer	99V60-155		for 99S45 (Orange)	99S45-204-W10
12	Valve Seat Lock Washer	H54U-352		for 99S60 (Blue)	99S60-204-W10
13	Valve Seat Screw	PS3-83	30	Front Rotor Bearing	R380-105
14	Throttle Lever Pin	MR-100	31	Front End Plate	99V60-11
15	Locking Lever Assembly	88V60-A400			
16	Lever Lock	88V60-402			
17	Lever Lock Spring	88V60-405			
18	Lever Lock Pin	502B-120			

* Not illustrated.

• To keep downtime to a minimum, it is desirable to have on hand certain repair parts. We recommend that you stock one (pair or set) of each part indicated by a bullet (•) for every four tools in service.

+ Whenever a new Cylinder Case Assembly is installed, select the correct Nameplate from the Nameplate Kit and attach it to the Cylinder case with the Nameplate Screws.

USE THIS DRAWING WITH PART LISTING FOR MODELS WITH BUILT-IN OILERS

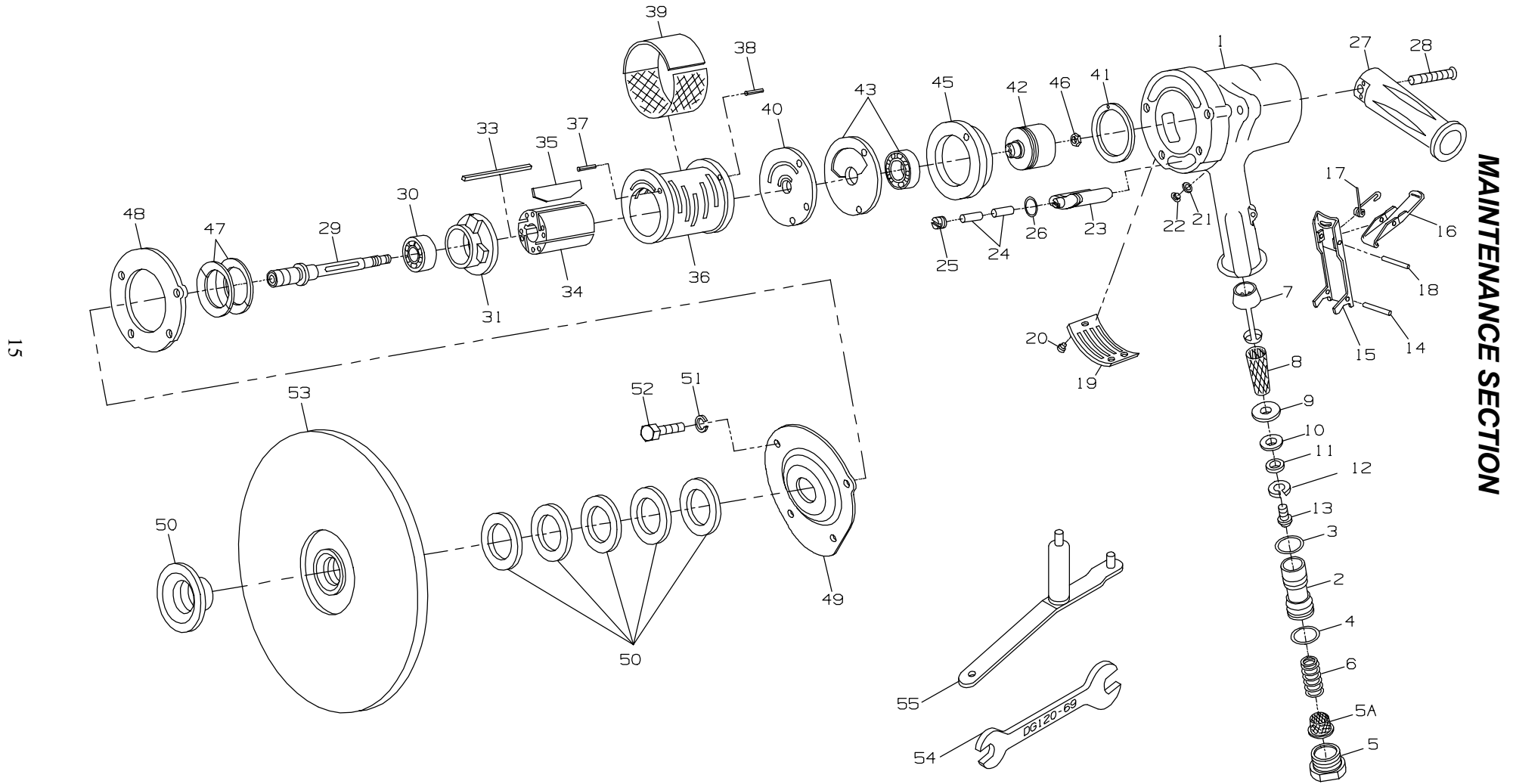

(Dwg. TPA1574-1)



USE THIS PART LISTING WITH DRAWING TPA1574-1 FOR MODELS WITH BUILT-IN OILERS

PART NUMBER FOR ORDERING

PART NUMBER FOR ORDERING

+ 1	Cylinder Case Assembly	—	19	Exhaust Deflector	99V60-23
2	Throttle Valve Assembly	99V60-A302	20	Exhaust Deflector Screw (3)	99V60-200
◆ 3	Small Seal	AFH120A-358	*	Nameplate Kit	99V-K301
◆ 4	Large Seal	C321-606		Nameplate Screw (4)	BN403-302
5	Inlet Bushing	88V60-38		Warning Label	WARNING-5-99
◆• 5A	Inlet Bushing Screen	834-61	◆ 21	Oiler Chamber Plug Washer	R3-92A
• 6	Throttle Valve Spring	99V60-262	22	Oiler Chamber Plug	231-665
7	Throttle Valve Seat Support Assembly	99V60-A303	23	Oiler Assembly	99V60-A198
◆• 8	Air Strainer Screen	99V60-61	◆ 24	Oiler Felt (2)	R1-75
9	Valve Seat Cap	R4-157	25	Oiler Adjusting Screw	R1-71A
◆• 10	Valve Seat	R4-159A	◆ 26	Oiler Body Seal	HRA20A-117
11	Valve Seat Washer	99V60-155	27	Dead Handle	99V60-48
12	Valve Seat Lock Washer	H54U-352	28	Dead Handle Screw	99V60-634
13	Valve Seat Screw	99V60-83	29	Arbor for 99S45 (Orange)	99S45-204-W10
• 14	Throttle Lever Pin	MR-100		for 99S60 (Blue)	99S60-204-W10
15	Locking Lever Assembly	99V60-A400A	30	Front Rotor Bearing	R380-105
16	Lever Lock	88V60-402	31	Front End Plate	99V60-11
17	Lever Lock Spring	88V60-405			
18	Lever Lock Pin	502B-120			

- * Not illustrated.
- ◆ Indicates Tune-up Kit part.
- To keep downtime to a minimum, it is desirable to have on hand certain repair parts. We recommend that you stock one (pair or set) of each part indicated by a bullet (•) for every four tools in service.
- + Whenever a new Cylinder Case Assembly is installed, select the correct Nameplate from the Nameplate Kit and attach it to the Cylinder case with the Nameplate Screws.

USE THIS PART LISTING FOR ALL MODELS

PART NUMBER FOR ORDERING 

PART NUMBER FOR ORDERING 

• 33	Rotor Key	R43F-70	55	Arbor Wrench (double end 5/8" x 3/4")	DG120-69
34	Rotor	99V60-53	56	Adjustable Spanner Wrench	AG230-26M
◆• 35	Vane Packet (set of 4 Vanes)	99V60-42-4	*	Piped-Away Exhaust Kit	99V60-K184
36	Cylinder Assembly	99V60-A3		Exhaust Hose	99V60-184
37	End Plate Dowel	5040-6		Exhaust Hose Clamp	DG30-67
38	Cylinder Dowel	502B-120		Exhaust Elbow	99V60-167
39	Exhaust Silencer	99V60-311		Exhaust Elbow Gasket	99V60-49
40	Rear End Plate	99V60-A12		Exhaust Elbow Screw (3)	FEA100-112
◆• 41	Rear End Plate Gasket	99V60-739		Exhaust Hose Band (4)	99V60-927
42	Controller Assembly (consists of Controller and Rotor Bearing Seal Assembly) for 99S45 (4500 rpm) (Orange) for 99S60 (6000 rpm) (Blue)	99V60-739 99V45-A524 99V60-A524		Exhaust Hose Band Screw (4) Nut (6) Screw (2)	MT1-36-7/8 G8-120A JC3350-103
43	Rotor Bearing Seal Assembly (consists of Rear Rotor Bearing and Rotor Bearing Seal)	99V60-A28A	*	Tune-up Kit (for models with built-in oiler) (includes illustrated parts 3, 4 [2], 5A [2], 8, 10, 21, 24 [2], 26, 35, 41 and 48)	99V/99H-TK3
45	Rotor Bearing Cage	99V60-107A	*	Exhaust Deflector Screw Wrench (1/8" hex)	R2J-562
46	Controller Retaining Nut for 99S45 for 99S60	R4-120 G8-120A	*	Maintenance Tool Kit	99V60-K950
47	Motor Clamp Belleville Washer (2)	99V60-207		Controller Wrench	99V60-950
◆• 48	Cylinder Case Gasket	99V60-283		Seal Pressing Tool	99V60-951
49	Motor Retaining Plate	99S60-55		Bearing Clamp	99V60-A952
50	Pad Mounting Kit	77A-826		Wheel Retaining Screw Wrench (5/32" hex)	88V-562
51	Cylinder Case Screw Lock Washer (4)	10BM-67			
52	Cylinder Case Screw (4)	99V60-638			
53	Sanding Pad Assembly with 5" Sanding Pad with 7" Sanding Pad (medium) with 7" Sanding Pad (firm) with 9" Sanding Pad	77A-AM825-5 77A-AM825-7 77A-BM825-7 77A-AM825-9			

* Not illustrated.

◆ Indicates Tune-up Kit part.

• To keep downtime to a minimum, it is desirable to have on hand certain repair parts. We recommend that you stock one (pair or set) of each part indicated by a bullet (•) for every four tools in service.

MAINTENANCE SECTION

WARNING

Always wear eye protection when operating or performing maintenance on this tool.

Always turn off the air supply and disconnect the air supply hose before installing, removing or adjusting any accessory on this tool, or before performing any maintenance on this tool.

LUBRICATION

Each time a Series 99S Vertical Air Sander is disassembled for maintenance and repair or replacement of parts, lubricate the tool as follows:

1. Inject approximately 1.5 cc of Ingersoll-Rand No. 50 Oil into the Inlet Bushing (5) after assembly. **For models with a built-in oiler**, fill the chamber of the Oiler Assembly (23). After each eight hours of operation, replenish the oil supply.
2. If the Sander is used in an extremely dirty environment, **once each week or after each forty hours of operation**, pour a liberal amount of a clean, suitable cleaning solution into the slots in the handle. Work the throttle lever vigorously to wash the cleaning solution around, and then pour the solution and accumulated dirt from the handle. Repeat this process until the cleaning solution is clean when it comes out of the handle. Immediately after flushing with the cleaning solution, inject a liberal amount of Ingersoll-Rand No. 50 Oil in the slots and again work the throttle lever vigorously to lubricate the cleaned parts.

OILER ADJUSTMENT

(for models with built-in oiler)

The built-in lubricator has been properly adjusted at the factory. If the oiler felts are clogged and must be replaced, proceed as follows:

1. Remove the Sanding Pad Assembly (53). Remove the Cylinder Case Screws (52), the Lock Washers (51), the Cylinder Case Gasket (48), the two Motor Clamp Washers (47) and the Motor Retaining Plate (49).
2. With a thin blade screwdriver, remove the Oiler Adjusting Screw (25) from the Oiler Assembly (23).
3. Using tweezers or a piece of bent wire, remove the Oiler Felts (24) and install new ones.
4. Replace the Oiler Adjusting Screw, installing it slightly below flush.

DISASSEMBLY

General Instructions

1. Do not disassemble the tool any further than necessary to replace or repair damaged parts.
2. Whenever grasping a tool or a part in a vise, always use leather-covered or copper-covered vise jaws to protect the surface of the part and help prevent distortion. This is particularly true of threaded members and housings.
3. Do not remove any part which is a press fit in or on a subassembly unless the removal of that part is necessary for repairs or replacement.
4. Do not disassemble the tool unless you have a complete set of new gaskets and O-rings for replacements.

Disassembly of the Motor

1. Lightly grasp the live air handle of the Sander in leather-covered or copper-covered vise jaws, Sanding Pad Assembly (53) up.
2. Remove the Sanding Pad Assembly, Cylinder Case Screws (52), the Lock Washers (51), the Cylinder Case Gasket (48), the two Motor Clamp Washers (47) and the Motor Retaining Plate (49).
3. Grasp the Arbor (29) in the vise and lift the Cylinder Case to expose the motor.
4. Remove the Exhaust Silencer (39).
5. **For models with a built-in oiler**, take the tool from the vise and dump the oil from its reservoir. The Oiler Assembly (23) can be pulled from the Cylinder Case, if necessary.

CAUTION

Use only the special No. 99V60-950 Controller Wrench for removing the Controller Assembly. Do not attempt to disassemble the Controller. It is available only as a unit and is guaranteed for the life of the tool if it is not abused.

NOTICE

The Controller Assembly (42) has a left-hand thread and the Controller Nut (46) has a right-hand thread.

6. Remove the Controller Nut and unscrew the Controller Assembly (42).
7. Lift off the Rear End Plate (40) and Rotor Bearing Seal.
8. Lift off the Cylinder (36).
9. Remove the Vanes (35).
10. Withdraw the Rotor (34) followed by the Rotor Key (33).
11. Lift off the Front End Plate (31).
12. If the Front Rotor Bearing (30) is to be replaced, press it and the Arbor from the Front End Plate. Press off the Bearing from the Arbor.

MAINTENANCE SECTION

13. Set the Controller on blocks in an arbor press. Using a round piece of metal fitting the inner race of the Rear Rotor Bearing, press off the Rear Rotor Bearing Cage (45).
14. Insert the Controller into the 99V60–A952 Bearing Clamp and tighten the nut on the fixture. Insert the 99V60–A951 Seal Pressing Tool in the center and press off the Controller. Release the clamp.

Disassembly of the Throttle and Inlet for Models without a built-in oiler

1. Place the Cylinder Case in the vise to remove the Inlet Bushing (5), Inlet Bushing Screen (5A) and the Throttle Valve Spring (6). The Bushing has an interference thread and is tightly fit.
2. Drive out the Throttle Lever Pin (14) to release the Lever Assembly (15).
3. Using a 3/32" hex wrench, reach inside the handle and remove the Valve Seat Screw (13) from the Throttle Valve Seat Support Assembly (7).
4. Thread a No. 8–32 screw about 5" (127 mm) long into the throttle valve seat support in place of the removed valve seat screw. A piece of 5/32" welding rod can be threaded on one end to serve the same purpose.
5. Grasp the protruding end of the screw in a vise, and while tapping lightly on the housing or handle with a plastic hammer, pull on the housing or handle to withdraw the throttle parts.
6. The Air Strainer Screen (8) can now be removed and cleaned.

Disassembly of the Throttle and Inlet for Models with a built-in oiler

1. Place the Cylinder Case in the vise to remove the Inlet Bushing (5) and Inlet Bushing Screen (5A).
2. Drive out the Throttle Lever Pin (14) to release the Lever Assembly (15).
3. Remove the Throttle Valve Spring (6) and release the Throttle Valve (2) by tapping the end of the handle with a soft hammer.
4. Bend a piece of 1/8" diameter rod as shown in Drawing TPD548. Insert this "puller" into the screw head and withdraw the Throttle Valve Seat Support Assembly (7) by hand, or with lever-wrench pliers, using a prying action if needed.

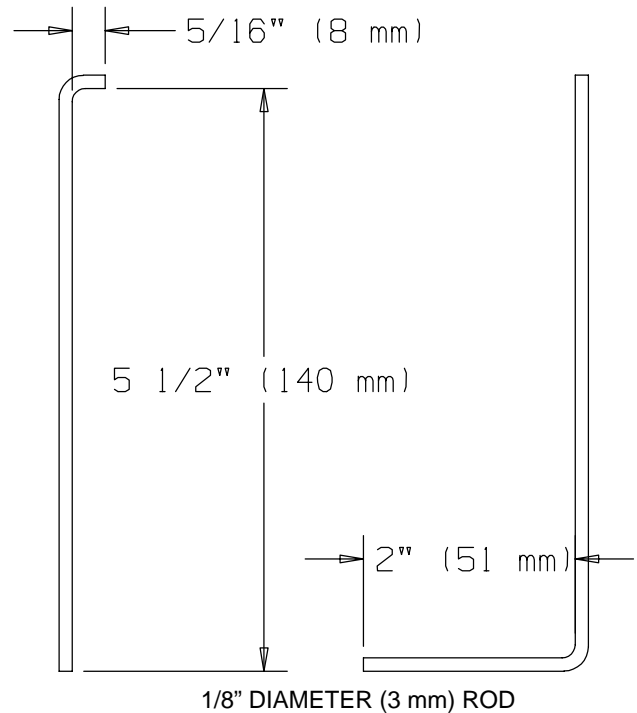

(Dwg. TPD548)

5. Remove the Valve Seat Screw (13), Valve Seat (10), Valve Seat Washer (11), Lock Washer (12) and Valve Seat Cap (9). The Air Strainer Screen (8) may now be removed.

ASSEMBLY

General Instructions

1. Always press on the **inner** ring of a ball-type bearing when installing the bearing on a shaft.
2. Always press on the **outer** ring of a ball-type bearing when pressing the bearing into a bearing recess.
3. Whenever grasping a tool or part in a vise, always use leather-covered or copper-covered vise jaws. Take extra care with threaded parts or housings.
4. Always clean every part and wipe every part with a thin film of oil before installation.
5. Apply a film of O-ring lubricant to all O-rings before final assembly.
6. Check every bearing for roughness. If an open bearing must be cleaned, wash it thoroughly in a suitable cleaning solution and dry with a clean cloth. **Sealed or shielded bearing should never be cleaned.** Work grease thoroughly into every open bearing before installation.

MAINTENANCE SECTION

Assembly of the Throttle and Inlet

NOTICE

Thoroughly clean and lubricate all Throttle Valve components before assembling the tool. Lubricate with Ingersoll–Rand Light Oil No. 10.

1. Grasp the live air handle in leather–covered or copper–covered vise jaws with the live air handle opening upward.
2. Assemble the Valve Seat Support parts.
3. Insert the Support Assembly (7) into the handle, large diameter first. Locate a punch on the flat of the screw head and tap it with a hammer until the Assembly is firmly seated.
4. Apply O–ring lubricant to the Seals (3) or (3 and 4). Fit the seals to the Throttle Valve (2) and push the assembly, small diameter first, into the handle until it seats firmly.

NOTICE

If Lever Assembly being serviced does not have the window–type lever, install a complete new Lever Assembly.

5. Assemble the Lever Assembly (15) as illustrated below.

Locking Lever Assembly

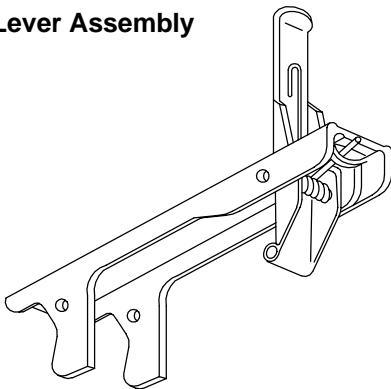

(Dwg. TPD563)

6. Align the holes in the Lever Assembly with the slots in the Cylinder Case. With a soft face hammer, tap the Throttle Lever Pin (14) through the Lever Assembly. File off any sharp edges. Operate the mechanism internally by hand to assure operation.
7. Insert the Throttle Valve Spring (6), small end first.
8. Clean the face of the Inlet Bushing (5) and the Inlet Bushing Screen (5A) using a suitable cleaning solution, and dry them. Insert the screen and bushing in the end of the Cylinder Case by grasping the flats

with a wrench. Tighten the Bushing between 35 and 45 ft–lb. (47 and 61 Nm) torque.

Assembly of the Motor

1. Using an arbor press against the inner race of the bearing, install the Front Rotor Bearing (30) onto the Arbor (29).
2. Inspect the Front End Plate (31) for nicks or burrs. Press the arbor bearing into the front end plate.
3. With the Arbor held firmly in vise jaws, place the Rotor Key (33) in the slot of the Rotor (34).

NOTICE

The Rotor should slip fit over the Arbor. If tightness is detected, lightly polish one long side of the Key using fine emery cloth on a hard, flat surface. Replace the Key with the polished side toward the Arbor.

4. The Rotor is counter–bored on one end. Place that end over the Arbor. Apply a light film of Ingersoll–Rand No. 50 Oil to each Vane (35) and insert one vane, straight end out, into each slot in the Rotor. If any new Vanes are required, replace the entire set.
5. Place the Cylinder Assembly (36) over the Rotor matching the End Plate Dowel (short dowel) (37) to the alignment hole in the Front End Plate (31).

NOTICE

If the Controller Assembly (42) needs to be replaced, you must also replace the Rotor Bearing Seal Assembly (43) which consists of the Rear Rotor Bearing and Rotor Bearing Seal. If either the Rear Rotor Bearing or Rotor Bearing Seal needs to be replaced, both must be replaced with a new Bearing and Seal. Do not mix old and new parts.

6. Clean the Rotor Bearing Seal (43) and measure the outside diameter and large inside diameter. If the outside diameter is worn to 1.1764” (29.88/mm) or smaller, and/or the large inside diameter is worn to 0.9103: (23.122 mm) or larger, install a new Rotor Bearing Seal.

NOTICE

Take all measurements 90 degrees to the left of the dowel hole when facing the hub side of the Seal.

7. Align the Rear End Plate (40), cavity and pin up, with the larger hole in the Rotor Bearing Seal.
8. Press the Rear Rotor Bearing onto the Controller Assembly (42). Press the Controller Assembly into the Bearing Cage (45) to within 1/8” of seating.

MAINTENANCE SECTION

9. Apply a film of light grease to the inside diameter and outside diameter of the Rotor Bearing Seal and align the Seal with both cylinder dowel pins.

NOTICE

Use only the special No. 99V60–950 Controller Wrench for installing the Controller Assembly. Tighten to 10 ft–lb (13.6 Nm) torque.

WARNING

Tighten the Controller to 14 to 16 ft–lb (19.0 to 21.7 Nm) torque. Do not exceed 16 ft–lb. The Controller may be damaged if this torque is exceeded. Always check the free speed of a Sander after it has been reassembled and before it is put back into service. Refer to the Test and Inspection Procedure.

Never use a Sander which runs in excess of the maximum speed listed in the Test and Inspection Procedure.

NOTICE

The Controller has a left–hand thread.

10. Slip the Controller Assembly over the arbor aligning the Dowel Pin hole with the Cylinder Dowel (38).
11. Apply the Controller Retaining Nut (46) and tighten to 6 ft–lb (8.1 Nm) torque for 99S45 Models, 9 ft–lb (12.2 Nm) for 99S60 models. Lightly tap both ends of the Arbor (29). The Arbor and Rotor (34) must turn freely when manually rotated, and the Cylinder (36) must have some play between the end plates.
12. Hold the Cylinder Case in a vise with the motor bore upward by gently clamping the Dead Handle (27).
13. Dampen the Rear End Plate Gasket (41) with Ingersoll–Rand No. 50 Oil, align it with the hole in the motor seat and place the Gasket in the Cylinder Case.

14. Center the long boss on the face of the Front End Plate (31) with the alignment mark on the face of the Cylinder Case and insert the motor into the bore approximately 1/2" (13 mm).
15. Wrap the Exhaust Silencer (39) around the Cylinder with the felt end over the exhaust ports in the Cylinder.
16. Slide the motor into the motor bore.

NOTICE

It may be necessary to slightly rotate the motor to fully seat it in the Cylinder Case bore.

17. Insert the two Motor Clamp Washers (47), beveled side down.
18. **For models with built–in oilers**, if the Oiler Assembly (23) was removed from the Cylinder Case, apply the Oiler Body Seal (26) to the lip of the Oiler Assembly (23), insert the Oiler Felts (24) and tighten the Oiler Adjusting Screw (25). Seat the assembly in the cavity of the Cylinder Case and fill the Oiler with the recommended oil.
19. Apply the Cylinder Case Gasket (48), the Motor Retaining Plate (49), the Cylinder Case Screw Lock Washers (51) and the four Screws (52). Slightly tighten opposite screws, make sure the arbor is free and then tighten all screws to 14 ft–lb (19 Nm) torque.
20. Again, make certain the Arbor is free.
21. The Dead Handle can be adjusted to two positions. **For models without a built–in oiler**, insert a 5" (127 mm) long 3/16" hex wrench into the elongated slot in the end of the Dead Handle (27) and loosen the screw securing the Handle to the Cylinder Case. Rotate the Handle 180° and tighten the screw to 18 ft–lb. (24.4 Nm) torque. **For models with a built–in oiler**, loosen the Dead Handle Screw (28), change the position of the Dead Handle and tighten the Screw to 9 ft–lb. (12.2 Nm) torque.

MAINTENANCE SECTION

TEST AND INSPECTION PROCEDURE



Disconnect the Sander from the air supply hose or shut off air to the tool before proceeding with the test and inspection procedure.

Run the performance tests at 90 psig (6.2 bar/620 kPa) air pressure at the inlet of the tool with an eight foot (2.44 m) length of 3/4" (19 mm) diameter air supply hose.

1. Without a sanding pad on the tool, operate the Sander with the Throttle Lever fully depressed and check the free speed by applying a hand-held tachometer to the spindle end. The minimum and maximum allowable free speeds are as follows:

Model	Stamped	Free Speed, rpm	
		Minimum	Maximum
99S45	4 500	4 300	4 550
99S60	6 000	5 650	6 050

2. Test the Sander motor for power to determine these minimum performance levels. The Throttle Lever must not be actuated repeatedly during the test. Depress the Lever and hold it in the open position until the test is complete.

Model	Torque		Speed rpm
	ft-lb	Nm	
99S45	3.80	5.15	3 300
99S60	3.50	4.75	4 400

3. There must be no objectionable leaks in any non-exhaust area. The Throttle must not leak when it is closed.
4. There must be no leaks past the closed Throttle that will run the motor.
5. The Sander must start smoothly when the Throttle Lever is depressed and must shut off completely when the Throttle Lever is released.
6. The Sander must be equipped with a spring-loaded window style Lever Lock (15). The Lever Lock must return to the locked position when the Throttle Lever is released.
7. The tool must run smoothly without noticeable vibration or unusual sound.
8. The Arbor (29) must turn freely with no evidence of brinelled bearings.
9. The Threads on the arbor must be free of nicks and damage.
10. The Nameplate must be legible, in place and securely fastened. Make replacement if necessary.

MAINTENANCE SECTION

TROUBLESHOOTING GUIDE

Trouble	Probable Cause	Solution
Low power or low free speed	Low air pressure at the Inlet	Check the air pressure at the Inlet. The pressure must not exceed 90 psig (6.2 bar/620 kPa).
	Plugged Screens	Clean the in Screen in a clean, suitable cleaning solution. If it cannot be cleaned, replace it. <div style="text-align: center;">⚠ WARNING</div> Never operate a Sander without an Inlet Screen. Ingestion of dirt into the Sander can, in some cases, cause an unsafe condition.
	Worn or broken Vanes	Replace the complete set of Vanes.
	Worn or broken Cylinder	Replace the Cylinder if it is worn or broken or if the bore is scored or wavy.
	Improper lubrication or dirt build-up in the motor	Lubricate the Sander as instructed in LUBRICATION SPECIFICATION . If lubrication does not result in satisfactory operation, disassemble the motor, inspect and clean all parts.
Rough operation	Worn or broken Rear Rotor Bearing or Front Rotor Bearing	Examine each Bearing. Replace the Rear Rotor Bearing Seal Assembly if worn or damaged or replace the Front Rotor Bearing.
	Worn Rotor Key	Replace the Key. Check the Arbor and Rotor for keyslot wear and replace if necessary.
	Bent Arbor	Mount the Arbor on centers. Check the bearing diameter runout with an indicator. Replace the Arbor if runout exceeds .002" Total Indicator Reading.
Scoring	Improper assembly	Make certain that all motor parts are properly aligned prior to clamping the motor assembly.
	Rotor Bearing Seal misalignment	Loosen the Cylinder Case Screws. Rotate the spindle by hand to align the seal. Re-tighten the Screws to 14 ft-lb (19 Nm) torque. The Spindle must rotate freely.
Air leaks	Worn Valve Seat or Valve Seat Washer	Replace worn parts.
	Worn Throttle Valve Seals	Replace both the Large and Small Seals.
	Worn Cylinder Case Gasket	Replace the Gasket.
	Oil Chamber Plug and Washer worn or not tight	Tighten the Plug. If the problem persists, replace the Washer.
	Distorted face on Cylinder Case	Polish lightly to remove high spots. If the Sander has been dropped and the Cylinder Case is damaged, replace with a new Cylinder Case Assembly.

NOTICE

SAVE THESE INSTRUCTIONS. DO NOT DESTROY.